

# LABOUNTY®

## 2024 PRODUCT CATALOG

### Selection, Innovation, Performance

The leader in mobile shears  
and the most expansive  
assortment of demolition  
attachments in North America



# YOUR TRUSTED PARTNER IN THE SCRAP AND DEMOLITION INDUSTRY

LaBounty has supplied the most reliable shear and demolition attachments to the market since 1973. When LaBounty invented the mobile shear in 1977, it drastically improved metal and concrete processing and transformed an entire industry.

With business output and efficiency top of mind, LaBounty continues to deliver mechanical and digital innovations that put customers at the forefront of productivity. Backed by one of the industry's best warranties and a world-class service and support team, users can spend time focusing on what matters most: because we know it's what's on the ground at the end of the day that counts.



**80+ DEALERS GLOBALLY**



**50+ YEARS IN SCRAP  
& DEMOLITION INDUSTRY**



**WORLD CLASS  
PRODUCT SUPPORT**













# LABOUNTY PRODUCT SUPPORT

When you buy a LaBounty attachment you become part of an exclusive group of strategic partners. We take pride in backing up our world-class products with the industry's most technologically advanced support team.

- In order to quickly respond to your installation, service and parts requirements our dedicated factory support team is available by phone at **833-723-1843** or email at **Labountyparts@sbdinc.com**.
- When you need on-site support our team of field service technicians are strategically placed in the United States to respond to your technical support and training requests.
- For deeper product training, we offer LaBounty training upon request and can cater to your needs. Please contact your LaBounty rep for more information.

**For up-to-date regional contact information,  
please visit:**

<https://industrialtoolsandattachments.com/en/contact/sales-service-directory>









# TABLE OF CONTENTS

## MOBILE SHEARS

---



## DEMOLITION ATTACHMENTS

DEMOLITION APPLICATIONS GUIDE 24

---



## MATERIAL HANDLING ATTACHMENTS

---



# MOBILE SHEARS









# LEGEND SERIES

## FEATURES & BENEFITS

The objective was simple: reduce maintenance and boost productivity. As a result, productivity and uptime were optimized. LaBounty® shears have demonstrated their effectiveness in scrap metal processing, bridge deconstruction, and industrial demolition for many years. The Legend Series Mobile shear include the industry's exclusive fully protected and indexable mobile shear tip - the Dual Max™ piercing tip.

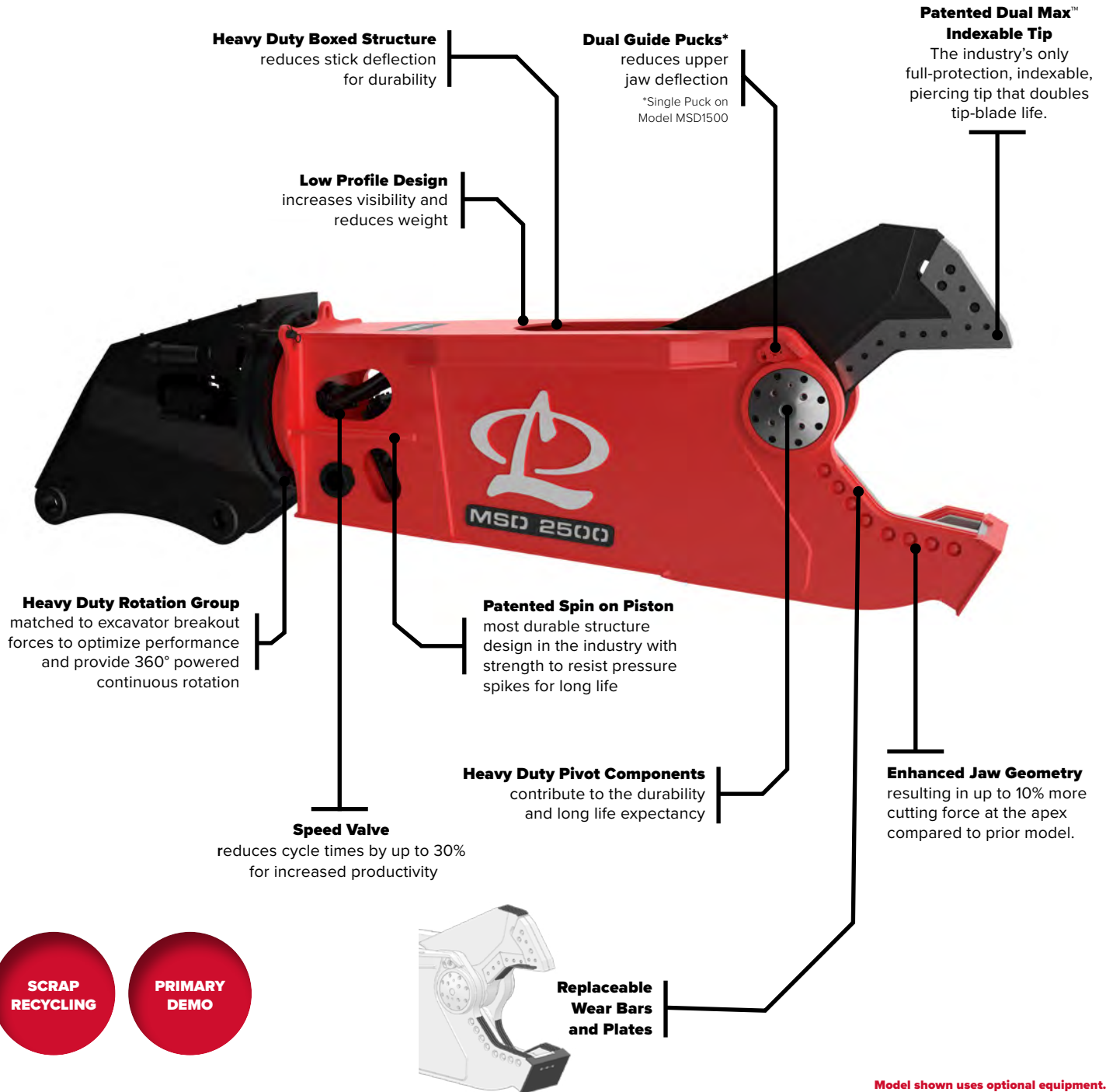



# SPECIFICATIONS

## MSD LEGEND SERIES - MOBILE SHEARS

Model	Weight*		Jaw Opening		Jaw Depth		Reach**		Min Excavator Weight - 2nd Member***		Min Excavator Weight - 3rd Member***	
	lbs	kg	in	mm	in	mm	ft	m	lbs	mTons	lbs	mTons
MSD 1500	7,000	3,200	21	540	25	640	6.8	2.1	26,000	12	55,000	25
MSD 1500R	7,440	3,400	21	540	25	640	10.0	3.1	40,000	18	66,000	30
MSD 2000	9,000	4,100	28	710	29	740	8.0	2.4	42,000	19	70,000	32
MSD 2000R	11,000	5,000	28	710	29	740	10.8	3.3	48,000	22	88,000	40
MSD 2250	10,600	4,800	30	760	30	760	8.6	2.6	44,000	20	88,000	40
MSD 2250R	12,700	5,800	30	760	30	760	11.7	3.6	53,000	24	99,000	45
MSD 2500	11,900	5,400	31	790	33	840	8.7	2.7	51,000	23	88,000	40
MSD 2500R	14,800	6,700	31	790	33	840	12.7	3.9	66,000	30	110,000	50
MSD 3000	14,200	6,400	34	870	38	970	10.0	3.1	66,000	30	143,000	65
MSD 3000R	17,100	7,800	34	870	38	970	13.1	4.0	88,000	40	154,000	70
MSD 4000	17,100	7,800	38	970	43	1,090	11.5	3.5	77,000	35	143,000	65
MSD 4000R	19,800	9,000	38	970	43	1,090	14.8	4.5	99,000	45	165,000	75
MSD 4500	18,700	8,500	39	990	43	1,090	11.0	3.4	88,000	40	165,000	75
MSD 4500R	21,300	9,700	39	990	43	1,090	14.2	4.3	110,000	50	187,000	85
MSD 7500	27,000	12,300	43	1,090	44	1,120	12.0	3.7	121,000	55	CONSULT FACTORY	
MSD 7500R	30,900	14,000	43	1,090	44	1,120	15.4	4.7	150,000	68	CONSULT FACTORY	
MSD 9500	37,400	17,000	48	1,210	50	1,280	14.7	4.5	170,000	77	CONSULT FACTORY	
MSD 9500R	44,700	20,300	48	1,210	50	1,280	18.4	5.6	210,000	95	CONSULT FACTORY	

## MSD SABER SERIES - MOBILE SHEARS

Model	Weight*		Jaw Opening		Jaw Depth		Reach**		Min Excavator Weight - 2nd Member***		Min Excavator Weight - 3rd Member***	
	lbs	kg	in	mm	in	mm	ft	m	lbs	mTons	lbs	mTons
MSD 7R****	1,200	500	11	280	10	250	6.0	1.8	7,000	3	18,000	8
MSD 800	2,250	1,000	15	380	17	430	5.7	1.7	15,000	7	22,000	10
MSD 800R	2,750	1,200	15	380	17	430	7.2	2.2	18,000	8	26,000	12
MSD 1000	4,200	1,900	19	480	20	510	6.0	1.8	20,000	9	35,000	16
MSD 1000R	4,400	2,000	19	480	20	510	8.5	2.6	22,000	10	40,000	18

\*Weight includes standard excavator mounting bracket. Attachment weight may vary depending on mounting configuration as well as options.

\*\* Reach is measured from the attachment mounting pivot (boom or stick) forward to the end of the jaw.

\*\*\* Excavator weight range is a guide only. 2nd member configurations at or near min/max excavator weight and all 3rd member configurations must be preapproved by LaBounty. Quick couplers, short swing machines, long arms all impact carrier size recommendation.

\*\*\*\*Legacy B-Series, not Saber Series Shear.

LaBounty reserves the right to improve, update, or change the product specifications, appearance, or functional attributes without notice.

## BLS SERIES - BUCKET LINKAGE SHEARS

Model	Weight		Jaw Opening*		Jaw Depth		Min Excavator Weight - 3rd Member	
	lbs	kg	in	mm	in	mm	lbs	mTons
BLS 2000	2,900	1,300	20	510	20	510	44,000	20
BLS 3000	4,800	2,200	22	560	23	580	66,000	30

\*Jaw openings vary based on excavator specific geometry.

LaBounty reserves the right to improve, update, or change the product specifications, appearance, or functional attributes without notice.



# DESTROYER™ SERIES

## FEATURES & BENEFITS

Built for the harshest jobs, LaBounty's Destroyer Class Shear boasts integrated reinforcement and superior protection to minimize downtime and maximize productivity. Not only stronger, the Destroyer can take on bigger jobs so you can put more on the ground.

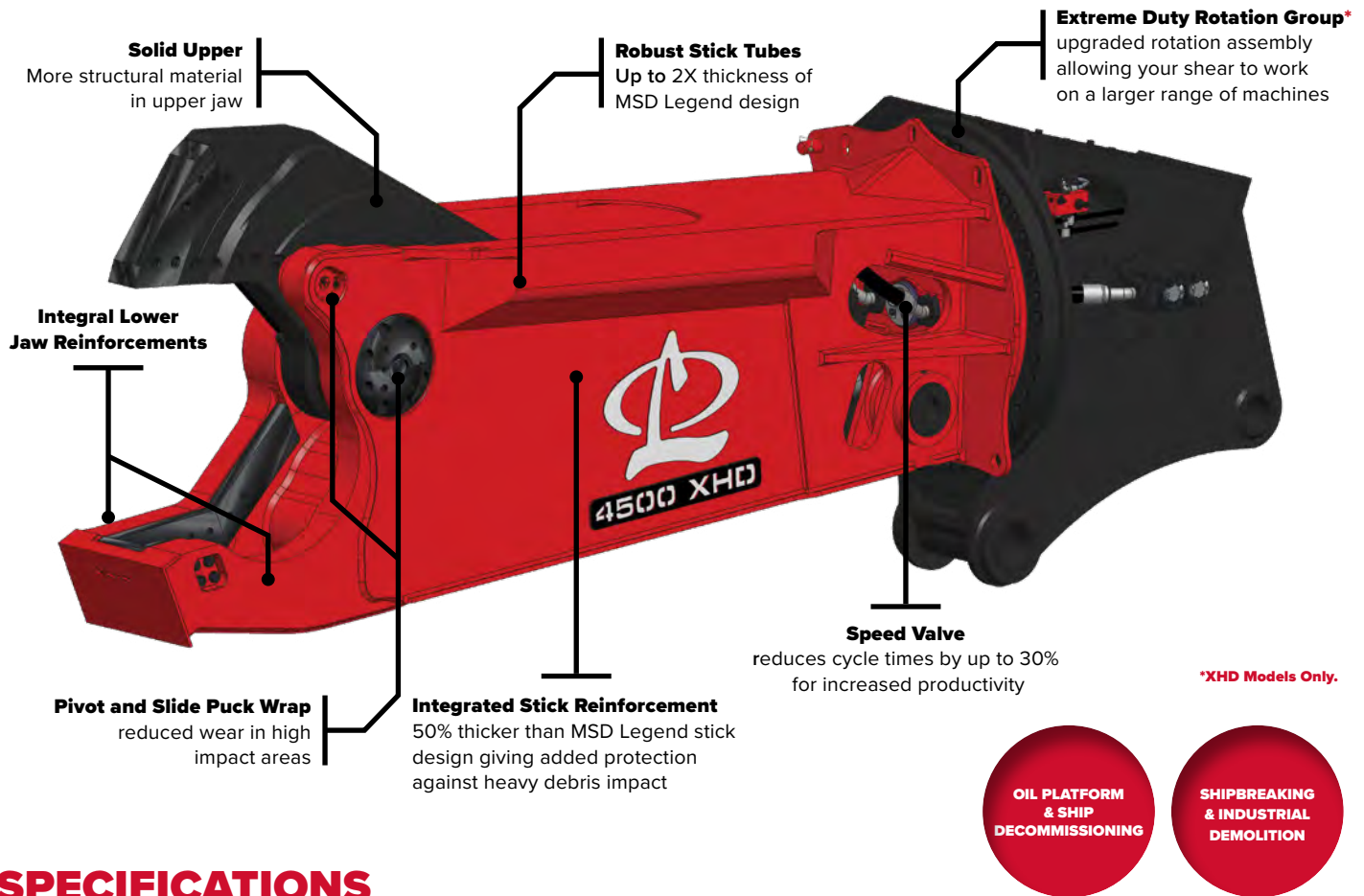

## SPECIFICATIONS

Model	Weight*		Jaw Opening		Jaw Depth		Reach**		Min Excavator Weight - 2nd Member***		Min Excavator Weight - 3rd Member***	
	lbs	kg	in	mm	in	mm	ft.	m	lbs	mTons	lbs	mTons
MSD 2500R HD	16,100	7,300	31	790	33	840	12.7	3.9	79,000	36	119,000	54
MSD 2500R XHD	16,400	7,400	31	790	33	840	11.9	3.6	81,000	37	143,000	65
MSD 3000R HD	18,500	8,400	34	870	38	970	13.1	4.0	99,000	45	165,000	75
MSD 4000R HD	21,700	9,900	38	970	43	1,090	14.8	4.5	110,000	50	180,000	82
MSD 4000R XHD	24,100	10,900	38	970	43	1,090	14.8	4.5	121,000	55	251,000	114
MSD 4500R HD	23,300	10,600	39	990	43	1,090	14.2	4.3	110,000	50	187,000	85
MSD 4500R XHD	25,700	11,700	39	990	43	1,090	14.2	4.3	132,000	60	264,000	120
MSD 7500R HD	33,200	15,100	43	1,090	44	1,120	15.4	4.7	160,000	73	CONSULT FACTORY	
MSD 7500R XHD	37,800	17,200	43	1,090	44	1,120	15.7	4.8	200,000	91	CONSULT FACTORY	
MSD 9500R HD	48,700	22,100	48	1,210	50	1,280	18.4	5.6	240,000	109	CONSULT FACTORY	

\*Weight includes standard excavator mounting bracket. Attachment weight may vary depending on mounting configuration as well as options.

\*\* Reach is measured from the attachment mounting pivot (boom or stick) forward to the end of the jaw.

\*\*\* Excavator weight range is a guide only. 2nd member configurations at or near min/max excavator weight and all 3rd member configurations must be preapproved by LaBounty. Quick couplers, short swing machines, long arms all impact carrier size recommendation.

LaBounty reserves the right to improve, update, or change the product specifications, appearance, or functional attributes without notice.

# BLADE KITS

**Get The Highest Quality Blade Kits For Your LaBounty® Mobile Shears**

## LABOUNTY PREMIUM

LaBounty Premium blades have been designed and time tested in an entire spectrum of applications; resulting in the perfect materials and heat treatments to insure you put more scrap on the ground year after year. Our Premium blades are available for all models of LaBounty's MSD Legend, Saber, and Destroyer Series Shears.



Saber Series Blades



Legend Series Blade Kit

## **Ni** LABOUNTY HIGH NICKEL

For maximum blade edge life, and less downtime for maintenance, turn to LaBounty's Ni blades which contain a 4% Nickel content. Our high Nickel primary and secondary blades are available for most models of LaBounty's MSD Legend, Saber, and Destroyer Series Shears.





# DEMOLITION ATTACHMENTS





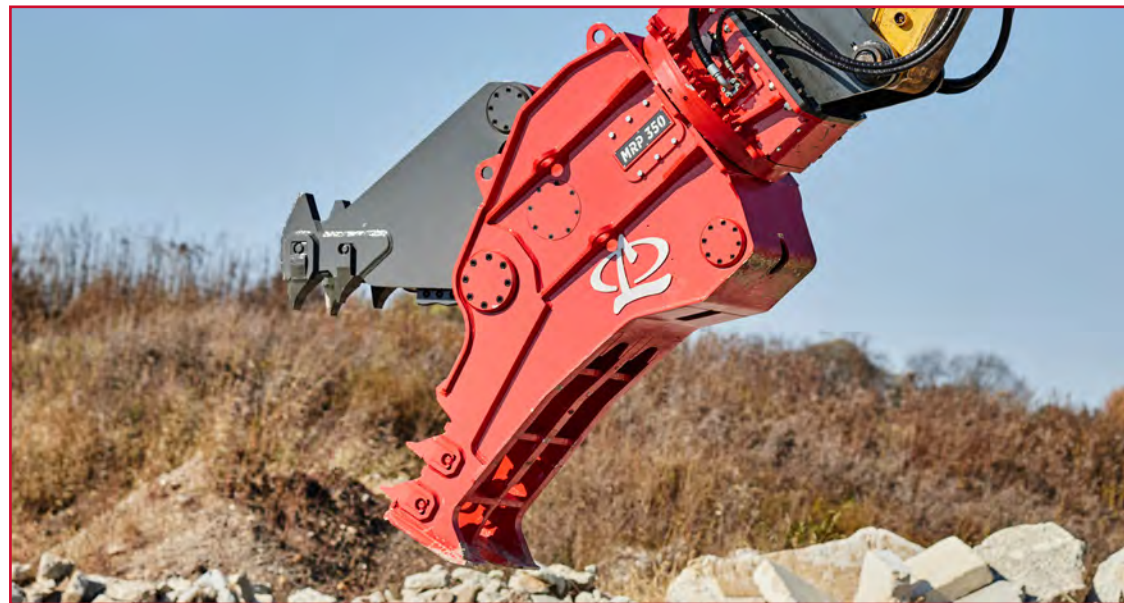



# UNIVERSAL PROCESSORS

## THE ULTIMATE MULTI-TASK TOOL

The next generation of award winning universal processors feature the industry's best power-to-weight ratio for uncompromising power, control, and versatility. These universal processors have multiple jaw set options which allows processing of a wide range of materials using a single tool.

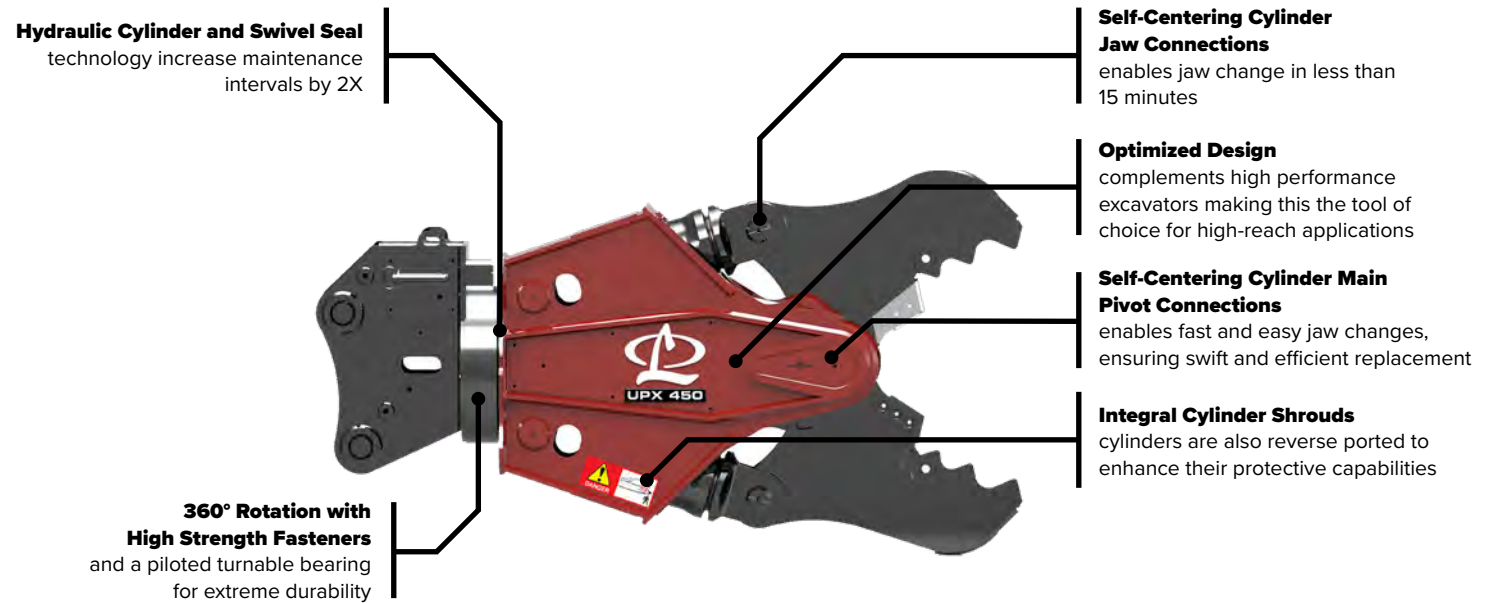

Model	Jaw	Weight (With Jaw)*		Jaw Opening		Jaw Depth		Reach**		Min Excavator Weight - 3 <sup>rd</sup> Member***	
		lbs	kg	in	mm	in	mm	ft	m	lbs	mTons
UPX 250	Shear (SH)	6,300	2,900	21	530	19	480	7.8	2.4	55,000	25
	Concrete Pulverizer (CP)	6,800	3,100	29	740	23	580	7.8	2.4	55,000	25
	Concrete Cracking (CC)	6,300	2,900	36	910	25	640	8.3	2.5	55,000	25
UPX 350	Shear (SH)	8,400	3,820	25	635	26	660	8	2.4	65,000	30
	Concrete Pulverizer (CP)	8,900	4,040	34	860	23	580	8	2.4	65,000	30
	Concrete Cracking (CC)	8,500	3,860	42	1,060	28	710	8	2.4	65,000	30
UPX 450	Shear (SH)	10,550	4,800	26	660	31	790	10.1	3.1	99,000	45
	Concrete Pulverizer (CP)	10,500	4,800	34	860	24	610	9.8	3.0	99,000	45
	Concrete Cracking (CC)	10,300	4,700	42	1,070	31	790	10.1	3.1	99,000	45
UPX 750	Shear (SH)	14,100	6,400	33	830	36	910	11	3.3	135,000	62
	Concrete Pulverizer (CP)	14,500	6,600	40	1,010	27	685	10.5	3.3	135,000	62
	Concrete Cracking (CC)	13,700	6,220	50	1,270	33	830	11	3.3	135,000	62
UPX 950	Shear (SH)	19,000	8,600	44	1,120	41	1,040	13.5	4.1	187,000	85
	Concrete Pulverizer (CP)	20,500	9,300	63	1,600	41	1,040	13.3	4.1	187,000	85
	Concrete Cracking (CC)	20,500	9,300	76	1,930	50	1,270	13.4	4.1	187,000	85
UPX 1800	Shear (SH)	33,600	15,300	48	1,220	46	1,170	15.5	4.7	CONSULT FACTORY	
	Concrete Cracking (CC) ****	35,500	16,100	73	1,850	50	1,270	15.5	4.7	CONSULT FACTORY	
UPX 2800 (HR)	Shear (SH)	45,000	20,400	51	1,300	52	1,320	19.5	5.9	CONSULT FACTORY	

\*Weight includes standard excavator mounting bracket. Attachment weight may vary depending on mounting configuration as well as options.

\*\* Reach is measured from the attachment mounting pivot (boom or stick) forward to the end of the jaw.

\*\*\* Excavator weight range is a guide only. 2nd member configurations at or near min/max excavator weight and all 3rd member configurations must be preapproved by LaBounty. Quick couplers, short swing machines, long arms all impact carrier size recommendation.

LaBounty reserves the right to improve, update, or change the product specifications, appearance, or functional attributes without notice.

# JAW TYPES

## CHOOSING THE RIGHT JAW

### CONCRETE CRACKING JAW - CC



CC JAW

Effectively breaks large, oversized concrete structures such as abutments and beams, making it ideal for primary demolition tasks. The entire jaw is constructed with high-grade, abrasion-resistant steel. Swift Lock teeth have been improved to enable quick changeover and reduce downtime, and are interchangeable with other LaBounty attachments. Additionally, it features rebar cutting blades in the throat.

NOTE: The UPX950 Concrete Cracking jaw is designed without Swift Lock Teeth and instead features weld-in replaceable teeth.



UPX 450 WITH CONCRETE CRACKING JAWS

### CONCRETE PULVERIZER JAW - CP



CP JAW

Ideal for demolishing concrete and segregating rebar with utmost efficiency. Its Swift Lock teeth have been enhanced to enable swift transitions and minimize unproductive periods, and are interchangeable with other LaBounty attachments. The jaw is constructed from top-notch, abrasion-resistant steel, and features rebar cutting blades located in the throat for added convenience.

NOTE: The UPX950 and UPX750 Concrete Cracking jaw are designed with weld-in replaceable teeth, which eliminates the need for Swift Lock Teeth. However, the UPX450 CC jaw, being the largest, features Swift Lock Teeth.



UPX 950 WITH CONCRETE PULVERIZER JAWS

### SHEAR JAW - SH



SH JAW

Capable of severing rebar and structural steel, such as I-beams, H-beams, pipes, and more. Its pivot components have been upgraded for greater longevity, while its patented cutting blade system offers superior performance and lessens the need for maintenance.

[CLICK HERE TO WATCH VIDEO OF UPX JAW SWAP](#)



UPX 450 WITH SHEAR JAWS



# MULTI-JAW DEMOLITION TOOL

## SINGLE-CYLINDER VERSATILITY

The MRX takes versatility to the next level with its three interchangeable jaws - a concrete pulverizer, concrete cracker, and shear - making it the ideal solution for primary and secondary demolition needs. Additionally, the MRX boasts a short center of gravity and 360-degree rotation, providing optimal maneuverability.

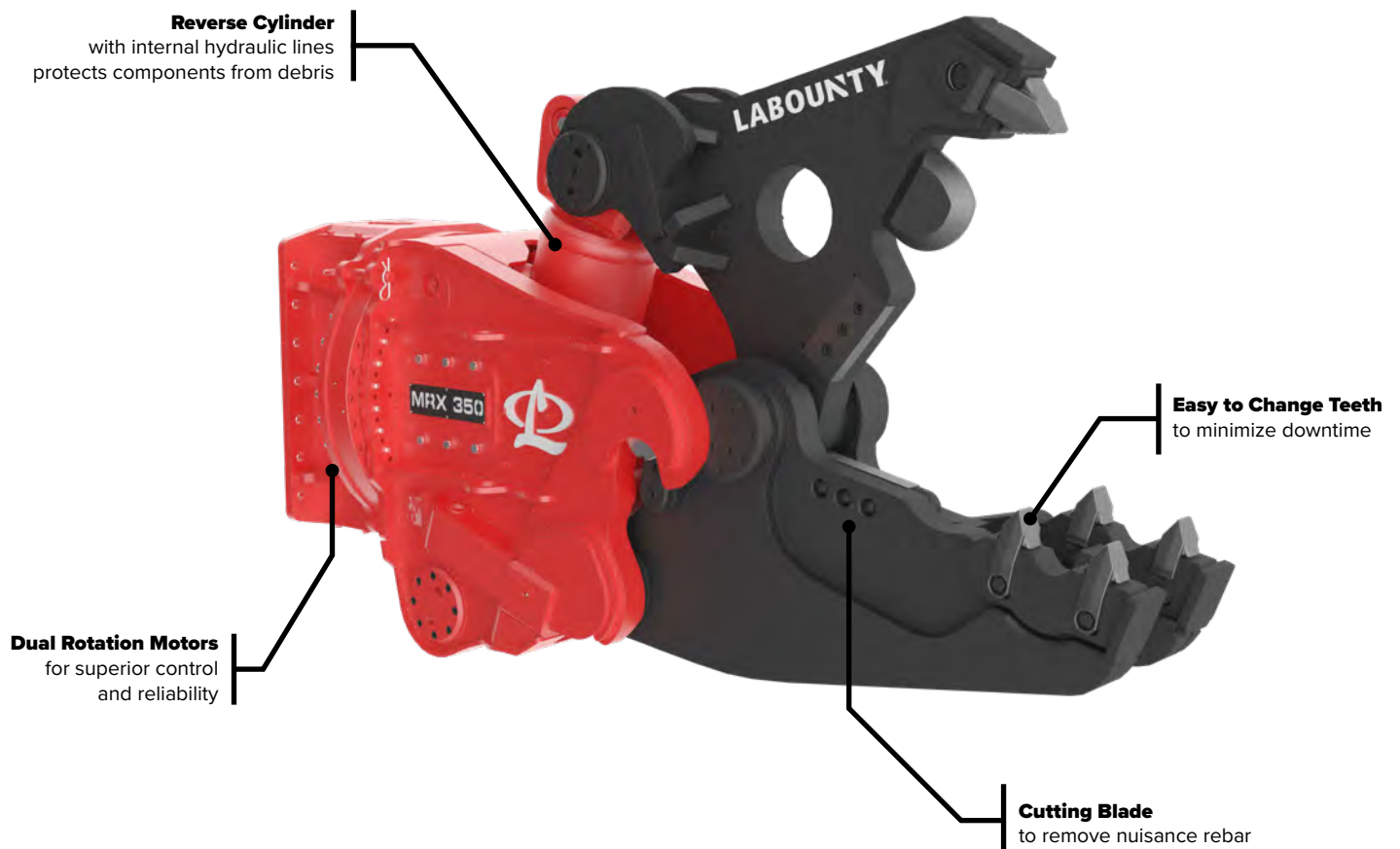

# SPECIFICATIONS

Model	Jaw	Weight (with jaw)*		Jaw Opening		Jaw Depth		Reach**		Min Excavator Weight - 3rd Member***	
		lbs	kg	in	mm	in	mm	ft	m	lbs	mTons
MRX 70	Shear (SH)	1,670	760	10	250	13	330	5.2	1.6	15,000	7
	Concrete Pulverizer (CP)	1,760	800	21	530	20	510	5.6	1.7	15,000	7
	Concrete Cracking (CC)	1,760	800	21	530	19	490	5.7	1.7	15,000	7
MRX 100	Shear (SH)	2,350	1,070	13	320	15	390	6.1	1.9	20,000	9
	Concrete Pulverizer (CP)	2,460	1,120	26	660	24	610	6.6	2.0	20,000	9
	Concrete Cracking (CC)	2,520	1,140	24	600	24	610	6.7	2.0	20,000	9
MRX 130	Shear (SH)	3,330	1,510	16	400	18	450	6.6	2.0	29,000	13
	Concrete Pulverizer (CP)	3,450	1,570	28	720	25	630	7.1	2.2	29,000	13
	Concrete Cracking (CC)	3,320	1,510	29	740	28	710	7.3	2.2	29,000	13
MRX 180	Shear (SH)	4,520	2,050	17	430	18	470	7.5	2.3	40,000	18
	Concrete Pulverizer (CP)	4,740	2,150	28	720	26	660	7.9	2.4	40,000	18
	Concrete Cracking (CC)	4,620	2,100	29	750	27	690	8.3	2.5	40,000	18
MRX 220	Shear (SH)	6,070	2,800	19	480	20	510	8.3	2.5	48,000	22
	Concrete Pulverizer (CP)	6,270	2,800	33	830	30	760	8.8	2.7	48,000	22
	Concrete Cracking (CC)	6,180	2,800	33	840	31	790	9.1	2.8	48,000	22
MRX 260	Shear (SH)	8,220	3,700	20	500	22	570	8.9	2.7	57,000	26
	Concrete Pulverizer (CP)	8,600	3,900	33	840	32	800	9.4	2.9	57,000	26
	Concrete Cracking (CC)	8,290	3,800	33	820	32	810	9.4	2.9	57,000	26
MRX 360	Shear (SH)	9,270	4,200	21	540	22	570	8.8	2.7	79,000	36
	Concrete Pulverizer (CP)	10,100	4,600	37	950	36	920	9.5	2.9	79,000	36
	Concrete Cracking (CC)	9,630	4,400	36	900	36	900	9.7	3.0	79,000	36
MRX 500	Shear (SH)	13,600	6,170	23	570	26	660	9.8	3.0	117,000	53
	Concrete Pulverizer (CP)	15,030	6,820	43	1,100	41	1,030	10.8	3.3	117,000	53
	Concrete Cracking (CC)	14,610	6,630	45	1,150	42	1,070	11.0	3.4	117,000	53
MRX 750	Shear (SH)	19,820	9,000	28	700	30	760	11.1	3.4	165,000	75
	Concrete Pulverizer (CP)	21,320	9,680	46	1,180	43	1,100	11.8	3.6	165,000	75
	Concrete Cracking (CC)	20,670	9,380	46	1,180	46	1,160	11.8	3.6	165,500	75

\*Weight includes standard excavator mounting bracket. Attachment weight may vary depending on mounting configuration as well as options.

\*\* Reach is measured from the attachment mounting pivot (boom or stick) forward to the end of the jaw.

\*\*\* Excavator weight range is a guide only. 2nd member configurations at or near min/max excavator weight and all 3rd member configurations must be preapproved by LaBounty. Quick couplers, short swing machines, long arms all impact carrier size recommendation.

LaBounty reserves the right to improve, update, or change the product specifications, appearance, or functional attributes without notice.

## CHOOSING THE RIGHT JAW - 5 MINUTE JAW CHANGES

### CONCRETE PULVERIZER - CP



### CONCRETE CRACKER - CC



### SHEAR JAW - SH





# MOBILE ROTATING PULVERIZERS

## PULVERIZE WITH POWER & SPEED

The MRP is a versatile tool that enables users to handle primary and secondary demolition projects with ease. With a short center of gravity and 360-degree rotation, it offers optimal maneuverability, while the jaw's design facilitates improved penetration and rapid material downsizing. Dual rotation motors provide superior holding power and durability, and replaceable wear areas encourage longevity and reduced maintenance.

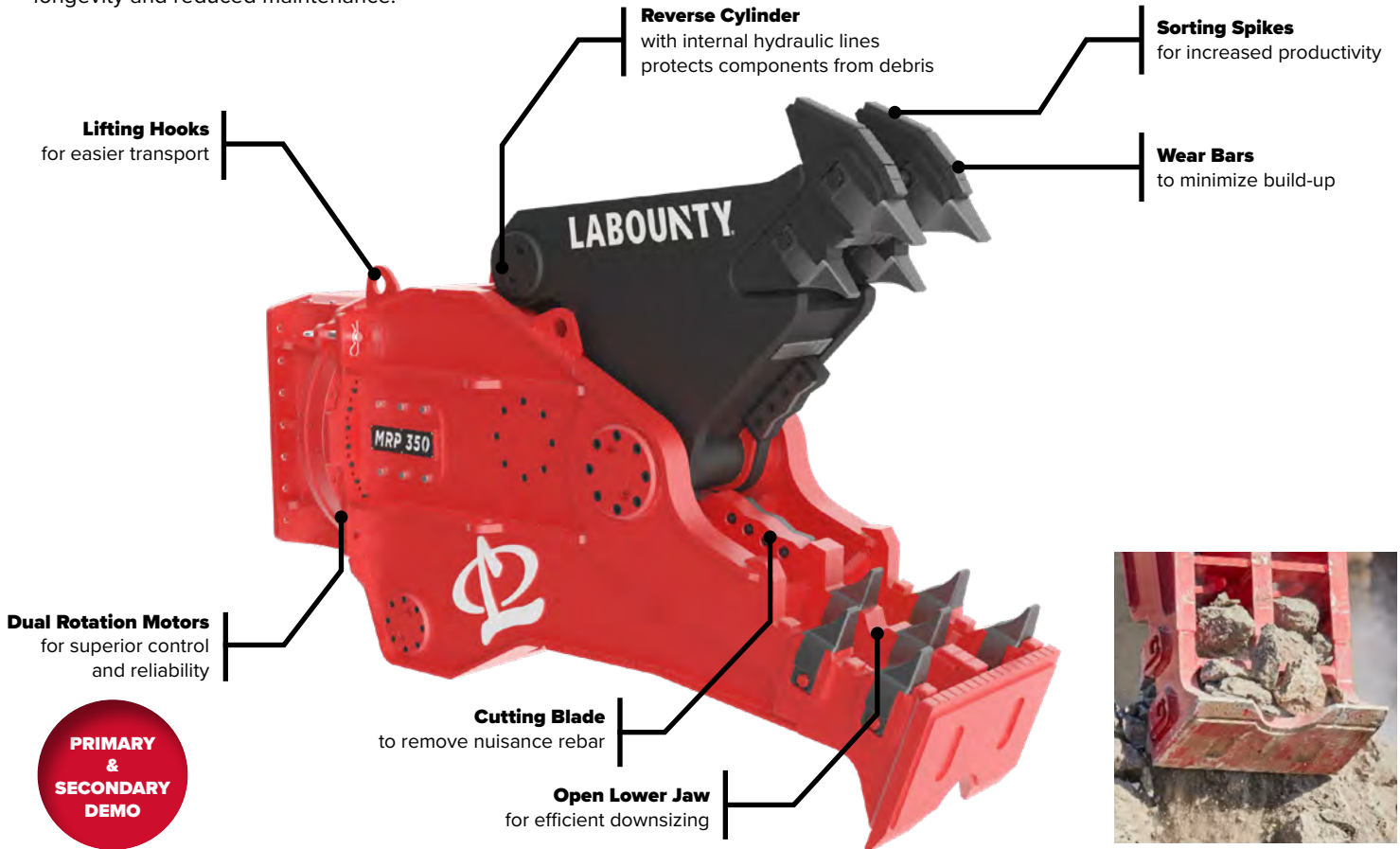

**PRIMARY  
&  
SECONDARY  
DEMO**

Model	Weight*		Jaw Opening		Jaw Depth		Reach**		Min Excavator Weight - 3rd Member***	
	lbs	kg	in	mm	in	mm	ft	m	lbs	m Tons
MRP 90****	2,285	1,000	26	660	22	570	6.0	1.8	20,000	9
MRP 130****	3,100	1,400	28	710	26	650	6.8	2.1	29,000	13
MRP 150	4,963	2,300	29	730	28	710	7.9	2.4	40,000	18
MRP 200	6,222	2,800	34	870	33	850	9.0	2.7	48,000	22
MRP 250	7,654	3,500	37	930	33	850	9.1	2.8	57,000	26
MRP 350	9,365	4,300	40	1,000	35	900	9.6	2.9	79,000	36
MRP 500****	13,400	6,100	44	1,120	38	960	10.3	3.1	110,000	50
MRP 700****	17,425	7,900	52	1,320	45	1,150	11.6	3.5	150,000	68
MRP 1000	29,840	13,500	65	1,650	57	1,460	14.2	4.3	189,000	86
MRP 2000****	50,670	23,000	75	1,900	75	1,900	16.2	4.9	CONSULT FACTORY	
MRP 2500****	55,820	25,300	81	2,050	75	1,900	18.4	5.6	CONSULT FACTORY	

\*Weight includes standard excavator mounting bracket. Attachment weight may vary depending on mounting configuration as well as options.

\*\* Reach is measured from the attachment mounting pivot (boom or stick) forward to the end of the jaw.

\*\*\* Excavator weight range is a guide only. 2nd member configurations at or near min/max excavator weight and all 3rd member configurations must be preapproved by LaBounty. Quick couplers, short swing machines, long arms all impact carrier size recommendation.

LaBounty reserves the right to improve, update, or change the product specifications, appearance, or functional attributes without notice.

# MOBILE DEMOLITION PROCESSORS

## PROVEN CRUSHING & CRACKING POWER

The LaBounty Mobile Demolition Processors (MDP) is a highly powerful attachment for crushing and processing concrete in both primary and secondary demolition. The MDP provides **unmatched power-to-weight** for crushing the hardest concrete with smaller excavators, as compared to the competition. With patented Swift Lock Teeth makes maintenance quick and easy, and are interchangeable with other LaBounty attachments. The MDP design is based on the time-tested LaBounty shear and carries forward the legendary performance and durability that only LaBounty can deliver.



Model	Jaw	Weight*		Jaw Opening		Jaw Depth		Reach**		Min Excavator Weight - 3rd Member***	
		lbs	kg	in	mm	in	mm	ft	m	lbs	m Tons
MDP 20R	Concrete Cracking (CC)	4,600	2,100	25	640	27	690	9.8	3.0	40,000	18
MDP 20R	Concrete Pulverizer (CP)	5,250	2,400	25	640	27	690	9.8	3.0	40,000	18
MDP 27R	Concrete Cracking (CC)	6,300	2,900	32	810	31	790	9.6	2.9	55,000	25
MDP 27R	Concrete Pulverizer (CP)	6,950	3,200	28	710	30	760	9.6	2.9	55,000	25
MDP 35R	Concrete Cracking (CC)	8,250	3,700	38	970	36	910	11.3	3.4	70,000	32
MDP 35R	Concrete Pulverizer (CP)	9,000	4,100	34	860	36	910	11.3	3.4	70,000	32
MDP 50R	Concrete Cracking (CC)	12,400	5,600	50	1,270	45	1,140	13.1	4.0	99,000	45
MDP 50R	Concrete Pulverizer (CP)	13,900	6,300	50	1,270	45	1,140	13.1	4.0	99,000	45

\*Weight includes standard excavator mounting bracket. Attachment weight may vary depending on mounting configuration as well as options.

\*\* Reach is measured from the attachment mounting pivot (boom or stick) forward to the end of the jaw.

\*\*\* Excavator weight range is a guide only. 2nd member configurations at or near min/max excavator weight and all 3rd member configurations must be preapproved by LaBounty. Quick couplers, short swing machines, long arms all impact carrier size recommendation.

LaBounty reserves the right to improve, update, or change the product specifications, appearance, or functional attributes without notice.



# MOBILE HYDRAULIC PULVERIZERS

## MAXIMUM CRUSHING POWER

Designed for high efficiency secondary demolition and concrete recycling, the LaBounty Mobile Hydraulic Pulverizers (MHP) offer **industry-leading power-to-weight ratio** with large jaw capacities. The all-new MHP design has been optimized to pick-up, crush, and separate rebar from concrete faster than ever before thanks to high-tip forces, a large jaw, and fast cycle times.

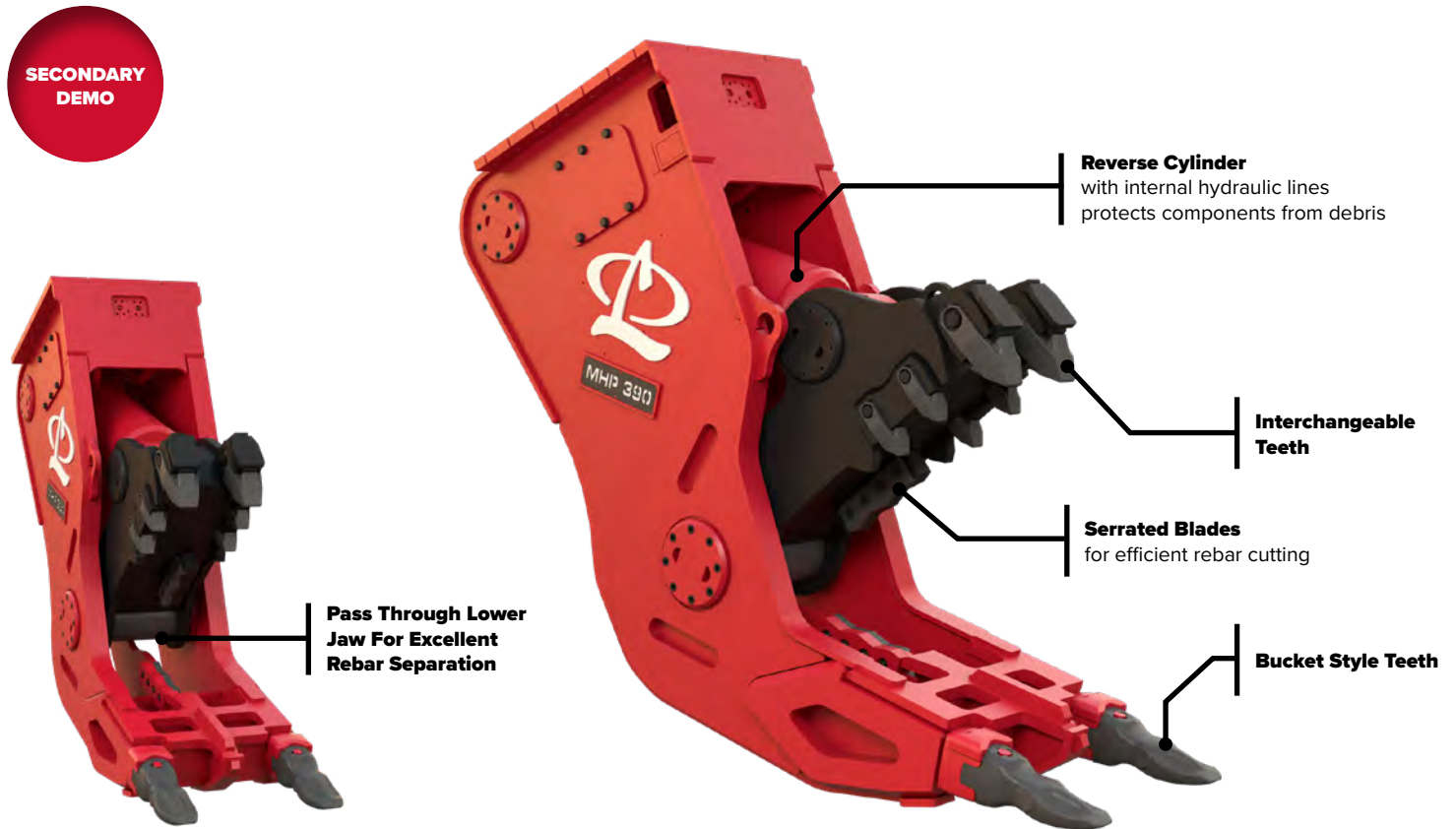

Model	Weight*		Jaw Opening		Jaw Width		Reach**		Min Excavator Weight - 3rd Member***	
	lbs	kg	in	mm	in	mm	ft	m	lbs	mTons
MHP 80	1,750	800	21	530	14	370	5.2	1.6	13,000	6
MHP 150	3,000	1,400	28	700	18	460	6.1	1.8	29,000	13
MHP 220	4,680	2,100	33	830	21	540	7.1	2.2	40,000	18
MHP 300	6,330	2,900	34	870	26	670	7.4	2.3	55,000	25
MHP 390	7,740	3,500	37	950	29	740	7.9	2.4	73,000	33
MHP 550	10,680	4,800	45	1,130	30	760	8.9	2.7	99,000	45
MHP 750	15,050	6,800	49	1,250	32	800	9.8	3.0	143,000	65

\*Weight includes standard excavator mounting bracket. Attachment weight may vary depending on mounting configuration as well as options.

\*\* Reach is measured from the attachment mounting pivot (boom or stick) forward to the end of the jaw.

\*\*\* Excavator weight range is a guide only. 2nd member configurations at or near min/max excavator weight and all 3rd member configurations must be preapproved by LaBounty. Quick couplers, short swing machines, long arms all impact carrier size recommendation.

LaBounty reserves the right to improve, update, or change the product specifications, appearance, or functional attributes without notice.

# CONCRETE PULVERIZERS

## SMART INVESTMENT, PROVEN RESULTS

The Concrete Pulverizers (CP) design efficiency uses existing excavator hydraulics for maximum crushing power with minimal investment. Providing controlled demolition and recycling of concrete bridge decks, walls, floor slabs, foundations, silos, culverts, pillars, encased beams, pre-cast structures, and railings.

- CPs feature custom lever arms to provide maximum crushing power.
- CPs use existing excavator hydraulics – no additional circuits are required. A movable front jaw, actuated by the excavator’s bucket cylinder, closes into the stationary back jaw. The back jaw is pinned in place with a position arm which is pinned to a mounting pad welded on the lower surface of the excavator’s stick.
- 100% welds around heavy torque tubes to minimize torsional stresses.
- Swift Lock Pin on replaceable tooth system are standard on all CP models.

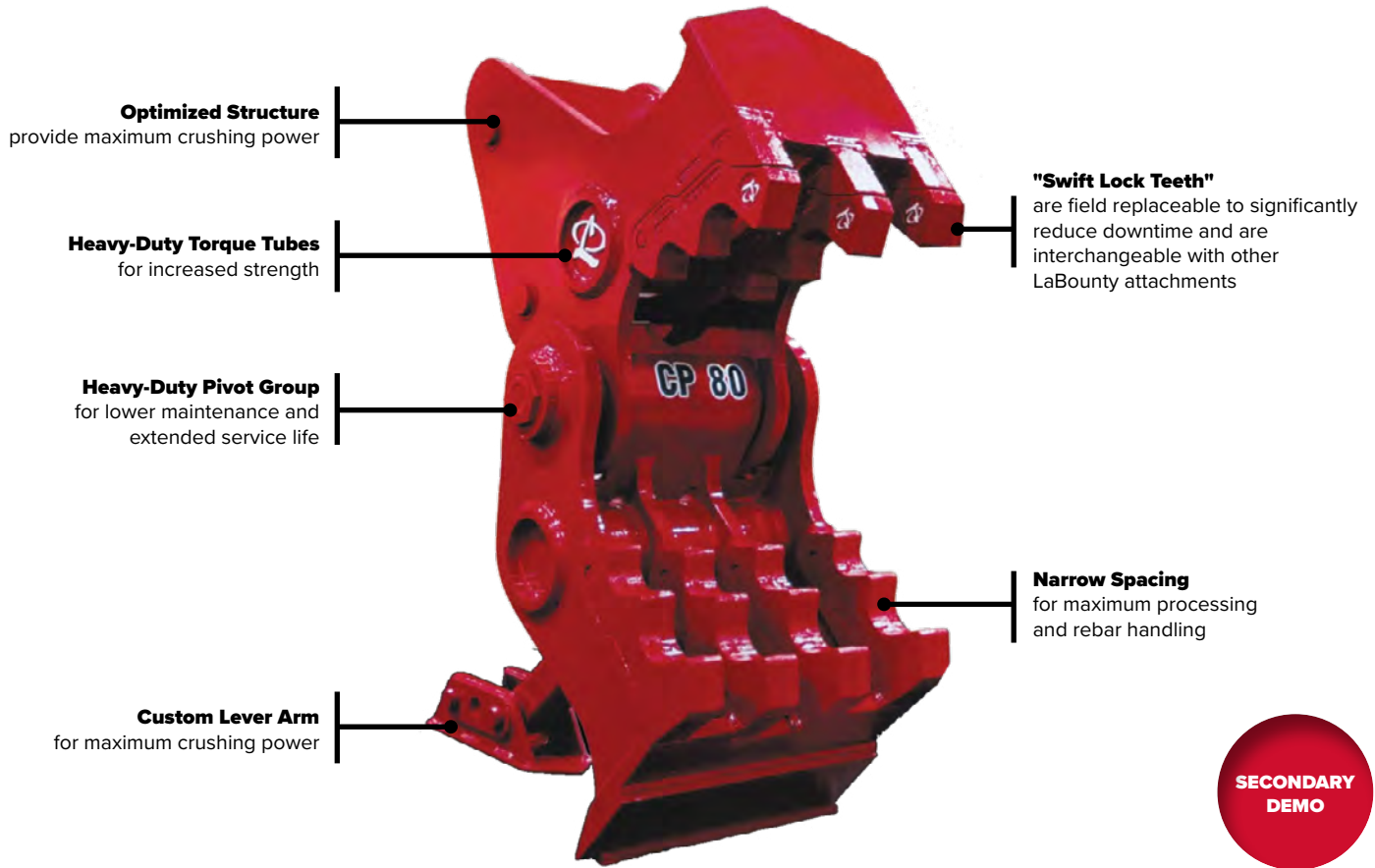

Model	Weight		Jaw Opening*		Jaw Depth		Min Excavator Weight - 3rd Member	
	lbs	kg	in	mm	in	mm	lbs	m Tons
CP 40**	2,900	1,300	30	760	25	640	35,000	16
CP 60**	3,000	1,400	36	910	27	690	46,000	21
CP 80**	4,500	2,000	42	1,070	29	740	64,000	29
CP 100**	6,200	2,800	48	1,220	35	890	88,000	40
CP 120**	10,000	4,500	54	1,370	40	1,020	110,000	50

\*Jaw openings vary based on excavator specific geometry.

\*\* Cannot be used with QC

LaBounty reserves the right to improve, update, or change the product specifications, appearance, or functional attributes without notice.



# DEMOLITION APPLICATIONS GUIDE

METRIC TON		3-8	9-12	13-15	16-21
PRIMARY DEMO	MSD	[Red Bar]			
	MDP				[Red Bar]
PRIMARY & SECONDARY DEMO	UPX				[Red Bar]
	MRX	[Red Bar]			
	MRP		[Red Bar]		
SECONDARY DEMO	MHP		[Red Bar]		
	CP				[Red Bar]

# Largest selection of demolition attachments in North America

**22-28**

**29-35**

**36-50**

**51-70**

**71-90**

**100-250**





# MATERIAL HANDLING









# MOBILE DEMOLITION GRAPPLES

## HANDLE, SORT & LOAD WITH PRECISION

The Mobile Demolition Grapple (MDG) is the ultimate tool for demolition, material handling, sorting, and loading. The continuous 360° high-torque rotation and synchronized jaw design combine to provide **enhanced material control**.

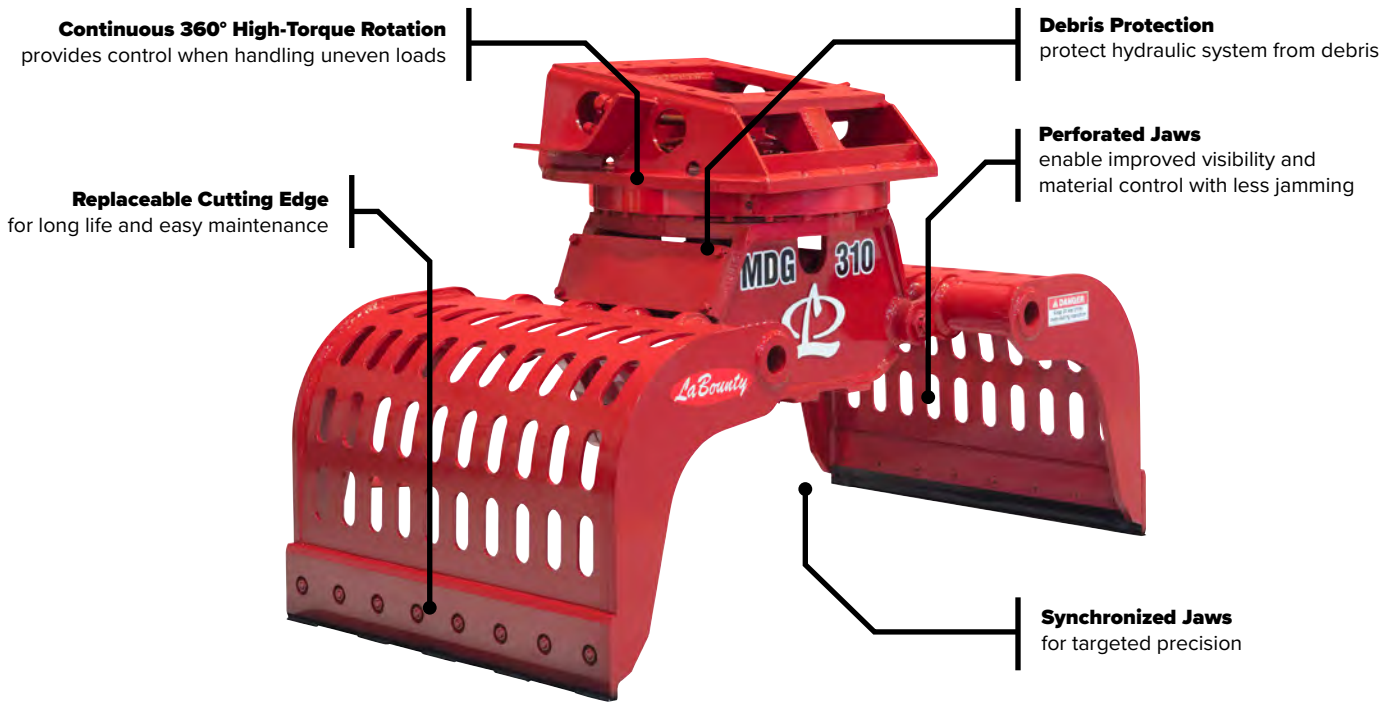

Model	Weight*		Opening		Jaw Width		Jaw Capacity**		Min Excavator Weight - 3rd Member***	
	lbs	kg	in	mm	in	mm	yd <sup>3</sup>	m <sup>3</sup>	lbs	m Tons
MDG 70	900	400	59	1,500	28	710	0.3	0.2	11,000	5
MDG 140	1,900	900	71	1,800	31	790	0.5	0.4	22,000	10
MDG 160	2,400	1,100	77	1,960	35	890	0.8	0.6	29,000	13
MDG 250	3,300	1,500	83	2,110	39	990	1.0	0.8	37,000	17
MDG 310	4,200	1,900	87	2,210	47	1,190	1.2	0.9	55,000	25
MDG 400	6,000	2,700	87	2,210	54	1,370	1.4	1.1	66,000	30

\* Weight excludes excavator mounting bracket.

\*\*Capacity will vary depending on the make up of the material being handled.

\*\*\* Excavator weight range is a guide only. 2nd member configurations at or near min/max excavator weight and all 3rd member configurations must be preapproved by LaBounty. Quick couplers, short swing machines, long arms all impact carrier size recommendation.

LaBounty reserves the right to improve, update, or change the product specifications, appearance, or functional attributes without notice.

# CONTRACTOR GRAPPLES

## THE ORIGINAL AND STILL THE BEST

With a proven design and a new mounting geometry, Universal HDR Grapples have been engineered to withstand rough usage and it's enhanced design includes a two-tine moveable upper half and a stationary lower half with three-tines. As the industry's go-to workhorse for more than 50 years, the HDR Series Contractor Grapples are still Made in the USA with global materials. This grapple is remarkably versatile, making it the preferred choice for various applications, from residential/commercial demolition and land clearing to scrap, rock, and waste handling.

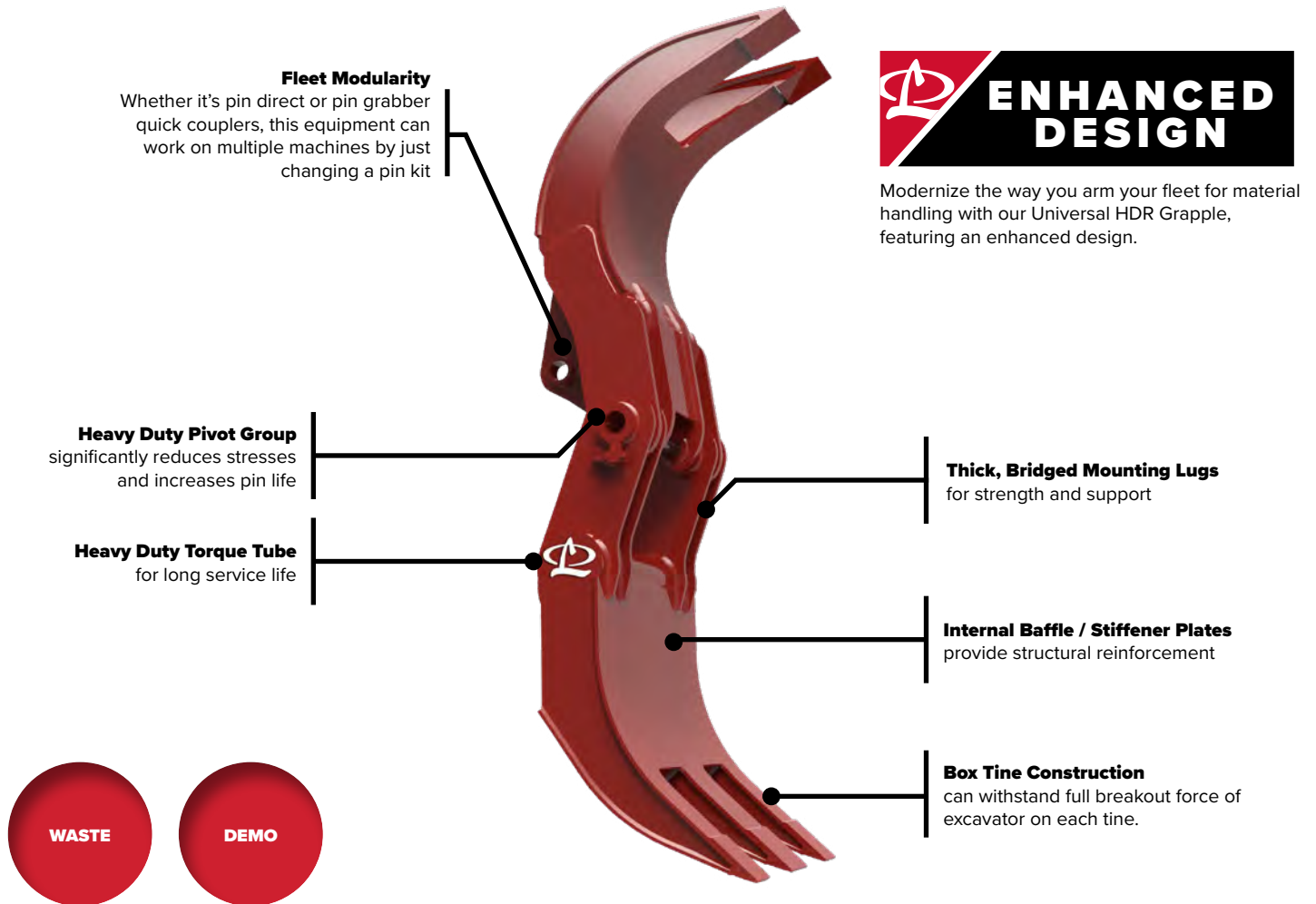

**ENHANCED DESIGN**

Modernize the way you arm your fleet for material handling with our Universal HDR Grapple, featuring an enhanced design.

Model	Weight*		Jaw Opening (min)**		Closed Grip Ø (min)		Capacity**		2-Tine Width		3-Tine Width		Min Excavator Weight - 3 <sup>rd</sup> Member***		QC Range Class
	lbs	kg	in	mm	in	mm	yd <sup>3</sup>	m <sup>3</sup>	in	mm	in	mm	lbs	m Tons	
HDR 210	3,500	1,600	108	2,470	12	290	2 - 3	1.5 - 2.3	31	790	45	1,140	32,000	15	5 & 6
HDR 250	4,500	2,000	114	2,900	13	320	2.5 - 3.5	1.9 - 2.7	31	790	45	1,140	45,000	21	7
HDR 350	6,200	2,800	127	3,230	13	320	3.5 - 5.5	2.7 - 4.2	33	840	49	1,240	65,000	30	8
HDR 450	7,600	3,500	140	3,560	16	410	5.5 - 6.5	4.2 - 5	35	890	53	1,350	75,000	35	9

\*Weight includes standard excavator mounting bracket. Attachment weight may vary depending on mounting configuration as well as options.

\*\*Jaw Opening and capacity will vary depending on excavator mounting and the handled material make up.

\*\*\* Excavator weight range should be used as a guide only; all mounting configurations must be preapproved by LaBounty.

LaBounty reserves the right to improve, update, or change the product specifications, appearance, or functional attributes without notice.



# SELECTION. INNOVATION. PERFORMANCE.

LaBounty was founded in 1973 by Roy LaBounty in Two Harbors, Minnesota. After constructing numerous Federal Forest roads using the equipment available at the time, Roy LaBounty realized the need for improved methods of removing trees and handling rocks. He subsequently retired from contracting and founded LaBounty Manufacturing.

The Contractor Grapple (HDR) was the original attachment developed by LaBounty Manufacturing. It was one of the first attachments, other than a bucket, designed for hydraulic excavators.

In 1977, LaBounty invented the first Hydraulic Shear, transforming the process of downsizing steel and making the manual method safer and more efficient for the worker. Since the beginning, LaBounty has continued to revolutionize the industry with innovative specialty excavator attachments for the scrap and demolition markets.

Come and see our commitment to quality firsthand at our manufacturing facility in Two Harbors, MN. With over 100,000 square feet of space, we utilize the latest technologies and employ the best industry professionals. Experience our state-of-the-art machine tools, advanced welding equipment, and comprehensive quality testing systems, all while discussing your questions firsthand with our team of experts. We welcome current and prospective customers to schedule a tour throughout the year during regular business hours.



Two Harbors, MN 

**47°14'35"N**  
**91°39'47"W**

## Bolt-on Guards Available for Many Excavator Makes/Models

### FRONT WINDOW GUARD

- Guards bolt to existing mounting locations on cab
- Full-size (12MT and up) guards tip out for cleaning
- Select screen guards tested to ISO 10262:1998
- Screen and polycarbonate inserts are interchangeable/replaceable
- Painted flat black to minimize glare
- Install time: <1 hour



BAR STYLE



SCREEN STYLE



POLYCARBONATE

Guard Type	Weight	Description	Application
Screen	Full Size: ≈ 110 lbs Mini-ex: ≈ 40 lbs	Laser-cut 3/16" steel with 1.88" square openings	General Purpose
1/2" Polycarbonate	Full Size: ≈ 130 lbs Mini-ex: ≈ 40 lbs	Mar/UV-resistant LEXAN MR-10 equivalent	Breaker, Land Management
Vertical Bars	Full Size: ≈ 110 lbs	1/4" steel bars	Demolition, Scrap, Forestry

### TOP GUARD

- Select guards tested to ISO 10262:1998
- Bolts to existing mounting locations on cab
- Includes provisions for mounting work lights
- Accommodates telematics antennas
- Install time: ≈ 1 hour
- Weight: ≈ 200 lbs





**SELECTION.  
INNOVATION.  
PERFORMANCE.**



**LABOUNTY®**