

STANLEY®

CT06 HYDRAULIC CRIMPING TOOL



USER MANUAL Safety, Operation and Maintenance



© 2014 Stanley Black & Decker, Inc.
New Britain, CT 06053
U.S.A.
58543 10/2014 Ver. 4

TABLE OF CONTENTS

SAFETY SYMBOLS	4
SAFETY PRECAUTIONS.....	5
TOOL STICKER & TAGS	6
HOSE TYPES.....	7
HOSE RECOMMENDATIONS	8
FIGURE 1. TYPICAL HOSE CONNECTIONS	8
HTMA REQUIREMENTS.....	9
OPERATION.....	10
FIGURE 2. OC/CC SETUP	10
TOOL PROTECTION & CARE	14
TROUBLESHOOTING	15
SPECIFICATIONS.....	16
CT06 PARTS ILLUSTRATION.....	17
CT06 PARTS LIST.....	18

IMPORTANT

To fill out a Product Warranty Validation form, and for information on your warranty, visit Stanleyhydraulics.com and select the Company tab, Warranty.
(NOTE: The warranty Validation record must be submitted to validate the warranty).

SERVICING: This manual contains safety, operation, and routine maintenance instructions. Stanley Hydraulic Tools recommends that servicing of hydraulic tools, other than routine maintenance, must be performed by an authorized and certified dealer. Please read the following warning.

⚠ WARNING

SERIOUS INJURY OR DEATH COULD RESULT FROM THE IMPROPER REPAIR OR SERVICE OF THIS TOOL.

REPAIRS AND / OR SERVICE TO THIS TOOL MUST ONLY BE DONE BY AN AUTHORIZED AND CERTIFIED DEALER.

For the nearest authorized and certified dealer, call Stanley Hydraulic Tools at the number listed on the back of this manual and ask for a Customer Service Representative.

SAFETY PRECAUTIONS

Tool operators and maintenance personnel must always comply with the safety precautions given in this manual and on the stickers and tags attached to the tool and hose.

These safety precautions are given for your safety. Review them carefully before operating the tool and before performing general maintenance or repairs.





Supervising personnel should develop additional precautions relating to the specific work area and local safety regulations. If so, place the added precautions in the space provided in this manual.

The model CT06 Hydraulic Crimping Tool will provide safe and dependable service if operated in accordance with the instructions given in this manual. Read and understand this manual and any stickers and tags attached to the tool and hose before operation. Failure to do so could result in personal injury or equipment damage.



- The operator must start in a work area without bystanders. Flying debris can cause serious injury.
- Make sure all critical tool markings, such as labels and warning decals, are securely in place and legible. Replace any that are damaged or missing.
- Do not operate the tool unless thoroughly trained or under the supervision of an instructor. Establish a training program for all operators to ensure safe operation.
- Always wear personal protection equipment (PPE) such as goggles, ear and head protection, and safety shoes at all times when operating the tool. Use gloves and aprons when necessary.
- Never wear loose clothing or unrestrained long hair that can get entangled in the working parts of the tool.
- Keep all parts of your body away from the tool and maintain proper footing and balance at all times.
- Do not rely exclusively upon the safety devices built into the tool.
- Always be well rested and mentally alert before operating the tool.
- The operator must be familiar with all prohibited work areas such as excessive slopes and dangerous terrain conditions.
- Know the location of buried or covered electrical services before starting work.
- Keep your work area clean and clear of tripping hazards. Oily surfaces and hoses lying around can be hazardous.
- Always operate the tool within its rated capacity.
- Do not use the tool for applications for which it was not designed.
- Do not inspect, clean or replace any part(s) if the hydraulic power source is connected. Do not inspect or clean the tool while the hydraulic power source is connected. Accidental engagement of the tool can cause serious injury.
- Always connect hoses to the tool hose couplers before energizing the hydraulic power source. Be sure all hose connections are tight and are in good condition.
- Always replace hoses, couplings, and other parts with replacement parts recommended by Stanley Hydraulic Tools. Refer to the parts list at the end of this manual for part numbers.
- Do not operate the tool at oil temperatures above 140 °F/60 °C. Operation at higher temperatures can cause higher than normal temperatures at the tool which can result in operator discomfort.
- Do not operate a damaged, improperly adjusted, or incompletely assembled tool. Do not carry tool by the hoses.
- Keep the handles dry, clean and free of oil.
- Ensure adequate lighting for the area where the tool is being used.
- Use proper lifting techniques when handling the tool. Do not overreach. Maintain secure footing and balance at all times.
- When using tools near energized transmission lines, be sure to use only hoses labeled and certified non-conductive.
- Turn off the power unit or move the hydraulic control valve to neutral before setting the tool down.
- To avoid personal injury or equipment damage, all tool repair, maintenance and service must only be performed by authorized and properly trained personnel.

TOOL STICKERS & TAGS

 <p>Stanley Hydraulic Tools 3810 SE Naef Road Milwaukie, OR 97267</p> <p>Model No. CT06</p> <p>11-04 (p/n 0-0) gpm 158 bar/2200 psi</p>	 WARNING
<p>OC/CC</p> <p>For use on open center and closed center hydraulic systems. Use open center tool on open center systems. Use closed center tool on closed center systems. Set tool for proper system before use.</p>	 <p>Read owners manual and make sure that you have been properly trained in the correct procedures required for work on or around electric lines. Failure to use hydraulic hose labeled and certified as non-conductive when using hydraulic tools on or near electric lines may result in death or serious injury.</p>
<p>CAUTION</p> <p>DO NOT OPERATE WITHOUT DIES</p>	 <p>Do not exceed specified flow or pressure. Correctly connect hoses to tool "IN" and "OUT". Improper handling, use or maintenance can result in a leak or burst. Contact at a leak or burst can cause oil injection to the body. Failure to observe the precautions can result in serious personal injury.</p>
	 <p>Stay clear of dies and tool heads. Failure to observe the precautions can result in serious personal injury.</p>

58500
CT06 1650 PSI Combined Sticker

NOTE:

THE INFORMATION LISTED ON THE STICKERS SHOWN, MUST BE LEGIBLE AT ALL TIMES.

REPLACE DECALS IF THEY BECOME WORN OR DAMAGED. REPLACEMENTS ARE AVAILABLE FROM YOUR LOCAL STANLEY DISTRIBUTOR.

The safety tag (P/N 15875) at right is attached to the tool when shipped from the factory. Read and understand the safety instructions listed on this tag before removal. We suggest you retain this tag and attach it to the tool when not in use.

DANGER

1. FAILURE TO USE HYDRAULIC HOSE LABELED AND CERTIFIED AS NON-CONDUCTIVE WHEN USING HYDRAULIC TOOLS ON OR NEAR ELECTRICAL LINES MAY RESULT IN DEATH OR SERIOUS INJURY.
BEFORE USING HOSE LABELED AND CERTIFIED AS NON-CONDUCTIVE ON OR NEAR ELECTRIC LINES BE SURE THE HOSE IS MAINTAINED AS NON-CONDUCTIVE. THE HOSE SHOULD BE REGULARLY TESTED FOR ELECTRIC CURRENT LEAKAGE IN ACCORDANCE WITH YOUR SAFETY DEPARTMENT INSTRUCTIONS.
2. A HYDRAULIC LEAK OR BURST MAY CAUSE OIL INJECTION INTO THE BODY OR CAUSE OTHER SEVERE PERSONAL INJURY.
 - A. **DO NOT EXCEED SPECIFIED FLOW AND PRESSURE** FOR THIS TOOL. EXCESS FLOW OR PRESSURE MAY CAUSE A LEAK OR BURST.
 - B. **DO NOT EXCEED RATED WORKING PRESSURE** OF HYDRAULIC HOSE USED WITH THIS TOOL. EXCESS PRESSURE MAY CAUSE A LEAK OR BURST.
 - C. CHECK TOOL HOSE COUPLERS AND CONNECTORS DAILY FOR LEAKS. **DO NOT FEEL** FOR LEAKS WITH YOUR HANDS. CONTACT WITH A LEAK MAY RESULT IN SEVERE PERSONAL INJURY.

IMPORTANT

READ OPERATION MANUAL AND SAFETY INSTRUCTIONS FOR THIS TOOL BEFORE USING IT.

USE ONLY PARTS AND REPAIR PROCEDURES APPROVED BY STANLEY AND DESCRIBED IN THE OPERATION MANUAL.

TAG TO BE REMOVED ONLY BY TOOL OPERATOR.

SEE OTHER SIDE

DANGER

- D. **DO NOT LIFT OR CARRY TOOL BY THE HOSES. DO NOT ABUSE HOSE. DO NOT USE KINKED, TORN OR DAMAGED HOSE.**
3. **MAKE SURE HYDRAULIC HOSES ARE PROPERLY CONNECTED TO THE TOOL BEFORE PRESSURING SYSTEM. SYSTEM PRESSURE HOSE MUST ALWAYS BE CONNECTED TO TOOL "IN" PORT. SYSTEM RETURN HOSE MUST ALWAYS BE CONNECTED TO TOOL "OUT" PORT. REVERSING CONNECTIONS MAY CAUSE REVERSE TOOL OPERATION WHICH CAN RESULT IN SEVERE PERSONAL INJURY.**
4. **DO NOT CONNECT OPEN-CENTER TOOLS TO CLOSED-CENTER HYDRAULIC SYSTEMS. THIS MAY RESULT IN LOSS OF OTHER HYDRAULIC FUNCTIONS POWERED BY THE SAME SYSTEM AND/OR SEVERE PERSONAL INJURY.**
5. **BYSTANDERS MAY BE INJURED IN YOUR WORK AREA. KEEP BYSTANDERS CLEAR OF YOUR WORK AREA.**
6. **WEAR HEARING, EYE, FOOT, HAND AND HEAD PROTECTION.**
7. **TO AVOID PERSONAL INJURY OR EQUIPMENT DAMAGE, ALL TOOL REPAIR MAINTENANCE AND SERVICE MUST ONLY BE PERFORMED BY AUTHORIZED AND PROPERLY TRAINED PERSONNEL.**

IMPORTANT

READ OPERATION MANUAL AND SAFETY INSTRUCTIONS FOR THIS TOOL BEFORE USING IT.

USE ONLY PARTS AND REPAIR PROCEDURES APPROVED BY STANLEY AND DESCRIBED IN THE OPERATION MANUAL.

TAG TO BE REMOVED ONLY BY TOOL OPERATOR.

SEE OTHER SIDE

SAFETY TAG P/N 15875 (Shown smaller than actual size)

HOSE TYPES

The rated working pressure of the hydraulic hose must be equal to or higher than the relief valve setting on the hydraulic system. There are three types of hydraulic hose that meet this requirement and are authorized for use with Stanley Hydraulic Tools. They are:

Certified non-conductive — constructed of thermoplastic or synthetic rubber inner tube, synthetic fiber braid reinforcement, and weather resistant thermoplastic or synthetic rubber cover. *Hose labeled **certified non-conductive** is the only hose authorized for use near electrical conductors.*

Wire-braided (conductive) — constructed of synthetic rubber inner tube, single or double wire braid reinforcement, and weather resistant synthetic rubber cover. *This hose is **conductive** and must never be used near electrical conductors.*

Fabric-braided (not certified or labeled non-conductive) — constructed of thermoplastic or synthetic rubber inner tube, synthetic fiber braid reinforcement, and weather resistant thermoplastic or synthetic rubber cover. *This hose is **not certified non-conductive** and must never be used near electrical conductors.*

HOSE SAFETY TAGS

To help ensure your safety, the following DANGER tags are attached to all hose purchased from Stanley Hydraulic Tools. **DO NOT REMOVE THESE TAGS.**

If the information on a tag is illegible because of wear or damage, replace the tag immediately. A new tag may be obtained from your Stanley Distributor.

THE TAG SHOWN BELOW IS ATTACHED TO “CERTIFIED NON-CONDUCTIVE” HOSE

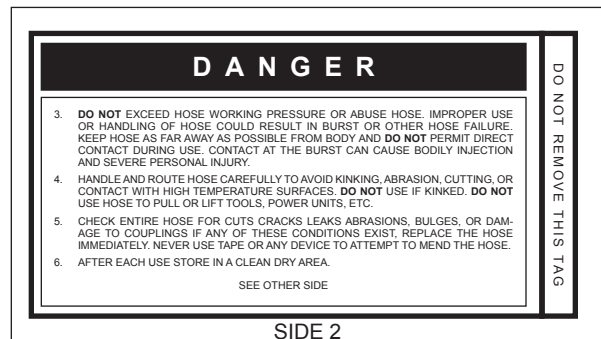
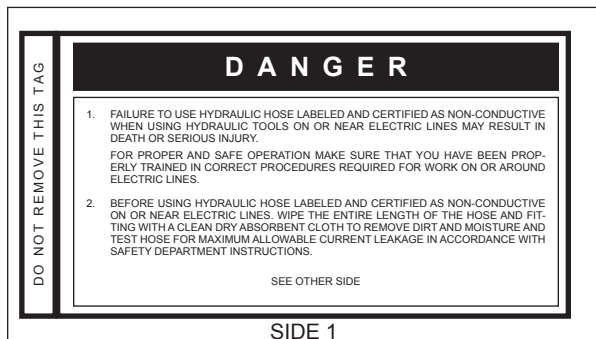

(Shown smaller than actual size)

THE TAG SHOWN BELOW IS ATTACHED TO “CONDUCTIVE” HOSE.

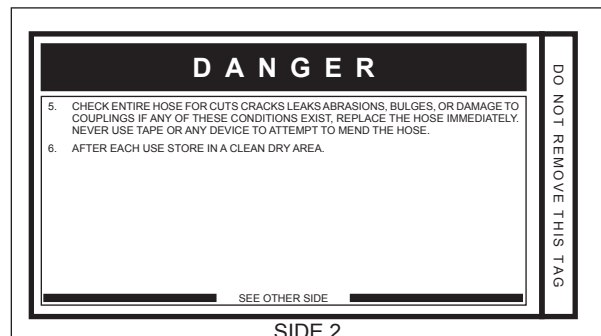
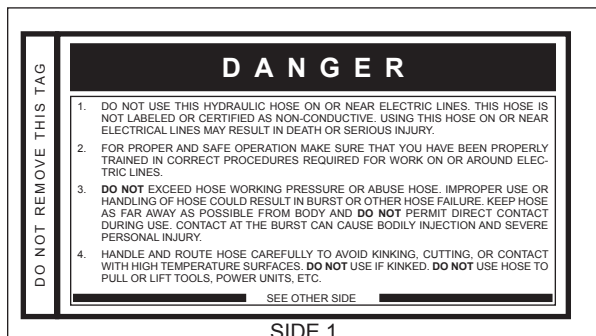

(Shown smaller than actual size)

HOSE RECOMMENDATIONS

Tool to Hydraulic Circuit Hose Recommendations

The chart to the right shows recommended minimum hose diameters for various hose lengths based on gallons per minute (gpm)/liters per minute (lpm). These recommendations are intended to keep return line pressure (back pressure) to a minimum acceptable level to ensure maximum tool performance.

This chart is intended to be used for hydraulic tool applications only based on Stanley Hydraulic Tools tool operating requirements and should not be used for any other applications.

All hydraulic hose must have at least a rated minimum working pressure equal to the maximum hydraulic system relief valve setting.

All hydraulic hose must meet or exceed specifications as set forth by SAE J517.

Oil Flow		Hose Lengths		Inside Diameter		USE (Press/Return)	Min. Working Pressure	
GPM	LPM	FEET	METERS	INCH	MM		PSI	BAR
Certified Non-Conductive Hose - Fiber Braid - for Utility Bucket Trucks								
4-9	15-34	up to 10	up to 3	3/8	10	Both	2250	155
Conductive Hose - Wire Braid or Fiber Braid -DO NOT USE NEAR ELECTRICAL CONDUCTORS								
4-6	15-23	up to 25	up to 7.5	3/8	10	Both	2500	175
4-6	15-23	26-100	7.5-30	1/2	13	Both	2500	175
5-10.5	19-40	up to 50	up to 15	1/2	13	Both	2500	175
5-10.5	19-40	51-100	15-30	5/8	16	Both	2500	175
5-10.5	19-40	100-300	30-90	5/8	16	Pressure	2500	175
10-13	38-49	up to 50	up to 15	3/4	19	Return	2500	175
10-13	38-49	51-100	15-30	5/8	16	Both	2500	175
10-13	38-49	100-200	30-60	3/4	19	Pressure	2500	175
13-16	49-60	up to 25	up to 8	5/8	16	Pressure	2500	175
13-16	49-60	26-100	8-30	3/4	19	Return	2500	175
				1	25.4	Return	2500	175
				5/8	16	Pressure	2500	175
				3/4	19	Return	2500	175
				3/4	19	Pressure	2500	175
				1	25.4	Return	2500	175

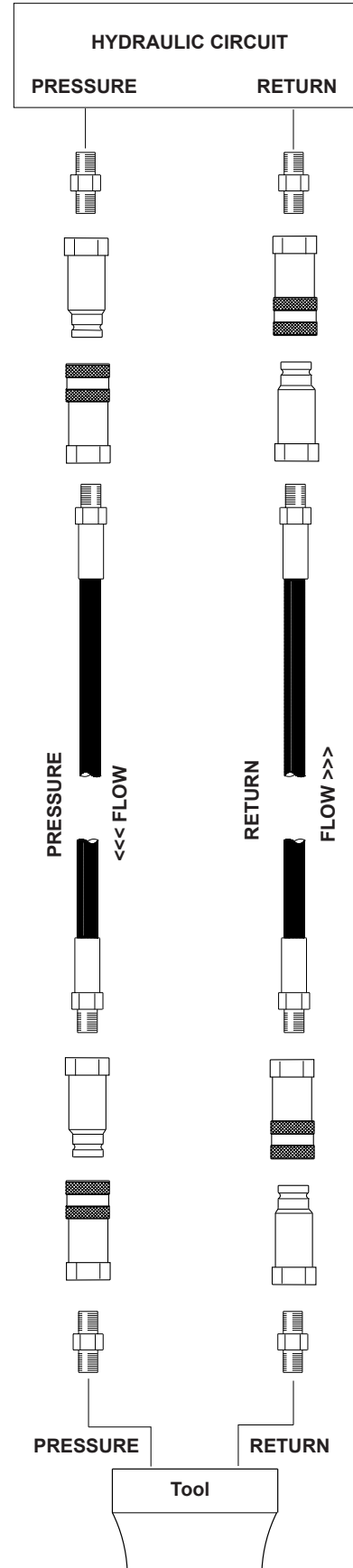

Figure 1. Typical Hose Connections

HTMA / EHTMA REQUIREMENTS

HTMA

HYDRAULIC SYSTEM REQUIREMENTS

TOOL TYPE

	TYPE I	TYPE II	TYPE RR	TYPE III
Flow Range	4-6 gpm (15-23 lpm)	7-9 gpm (26-34 lpm)	9-10.5 gpm (34-40 lpm)	11-13 gpm (42-49 lpm)
Nominal Operating Pressure (at the power supply outlet)	1500 psi (103 bar)	1500 psi (103 bar)	1500 psi (103 bar)	1500 psi (103 bar)
System relief valve setting (at the power supply outlet)	2100-2250 psi (145-155 bar)	2100-2250 psi (145-155 bar)	2200-2300 psi (152-159 bar)	2100-2250 psi (145-155 bar)
Maximum back pressure (at tool end of the return hose)	250 psi (17 bar)	250 psi (17 bar)	250 psi (17 bar)	250 psi (17 bar)
Measured at a max. fluid viscosity of: (at min. operating temperature)	400 ssu* (82 centistokes)	400 ssu* (82 centistokes)	400 ssu* (82 centistokes)	400 ssu* (82 centistokes)
Temperature: Sufficient heat rejection capacity to limit max. fluid temperature to: (at max. expected ambient temperature)	140° F (60° C)	140° F (60° C)	140° F (60° C)	140° F (60° C)
Min. cooling capacity at a temperature difference of between ambient and fluid temps	3 hp (2.24 kW) 40° F (22° C)	5 hp (3.73 kW) 40° F (22° C)	6 hp (5.22 kW) 40° F (22° C)	7 hp (4.47 kW) 40° F (22° C)
NOTE: Do not operate the tool at oil temperatures above 140° F (60° C). Operation at higher temperatures can cause operator discomfort at the tool.				
Filter Min. full-flow filtration Sized for flow of at least: (For cold temp. startup and max. dirt-holding capacity)	25 microns 30 gpm (114 lpm)	25 microns 30 gpm (114 lpm)	25 microns 30 gpm (114 lpm)	25 microns 30 gpm (114 lpm)
Hydraulic fluid Petroleum based (premium grade, anti-wear, non-conductive) Viscosity (at min. and max. operating temps)	100-400 ssu*	100-400 ssu* (20-82 centistokes)	100-400 ssu*	100-400 ssu*
NOTE: When choosing hydraulic fluid, the expected oil temperature extremes that will be experienced in service determine the most suitable temperature viscosity characteristics. Hydraulic fluids with a viscosity index over 140 will meet the requirements over a wide range of operating temperatures.				
*SSU = Saybolt Seconds Universal				

EHTMA HYDRAULIC SYSTEM REQUIREMENTS

CLASSIFICATION

Flow Range	3.5-4.3 gpm (13.5-16.5 lpm)	4.7-5.8 gpm (18-22 lpm)	7.1-8.7 gpm (27-33 lpm)	9.5-11.6 gpm (36-44 lpm)	11.8-14.5 gpm (45-55 lpm)
Nominal Operating Pressure (at the power supply outlet)	1870 psi (129 bar)	1500 psi (103 bar)	1500 psi (103 bar)	1500 psi (103 bar)	1500 psi (103 bar)
System relief valve setting (at the power supply outlet)	2495 psi (172 bar)	2000 psi (138 bar)	2000 psi (138 bar)	2000 psi (138 bar)	2000 psi (138 bar)

NOTE: These are general hydraulic system requirements. See tool specification page for tool specific requirements

OPERATION

PRE-OPERATION

Careful inspection of the tool and hydraulic system before startup is important for safe, reliable operation of the tool.

The following items should be checked daily at the start and the end of each work shift.

1. Make sure the proper dies are securely in place. Operating the tool without dies can deform the crimping heads. Refer to Die Installation for instructions.
2. Connect hoses. Wipe all hose couplers with a clean, lint-free cloth before making connections. Dirty couplers can contaminate the hydraulic lines and prevent a good seal at the connection.
3. Check all fasteners for tightness.
4. Check the equipment for oil leaks. If leaks are observed, do not use the tool; have the equipment serviced before use.
5. Check the tool and hydraulic system for proper operation and performance.
6. If the equipment does not appear to operate properly, have it serviced before use.
7. Periodically verify the crimping force of the tool. Refer to Die Load Verification.

SETUP AND TEST

Verify the crimping force before operating the tool.

OPEN CENTER/CLOSED CENTER SETUP

The CT06 Hydraulic Crimping Tool can be configured for either open-center or closed-center operation. The current setting is easily determined by looking at the gap between the adapter and the cylinder:

TO CHANGE THE CURRENT SETTING:

1. Remove the hydraulic hose coupling from the return port on the tool, if one is installed. When making the change from CC to OC, hydraulic fluid may be trapped in the tool, preventing complete movement of the adapter. Remove the return coupling to allow the hydraulic fluid to escape.

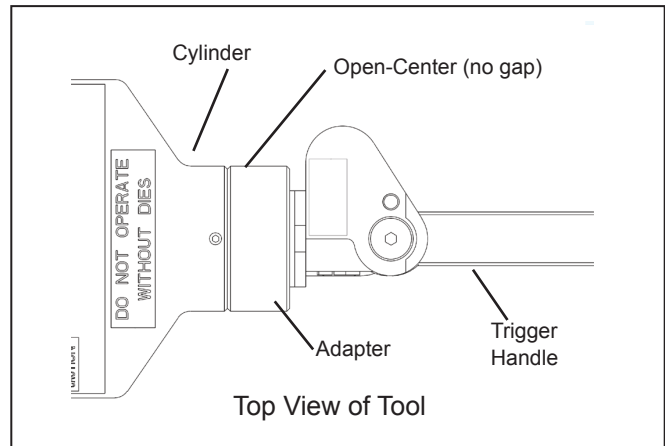

Figure 2. OC/CC Setup

2. Loosen the 2 setscrews on the cylinder.
3. Turn the adapter until it stops:
 - Counter clockwise (CCW) to change to closed center (creates gap)
 - Clockwise (CW) to change to open center (closes gap)
4. Tighten the two setscrews.

LATCH NIB REPLACEMENT

The CT06 Hydraulic Crimping Tool has two main components in the Anderson compression head:

- The *cam yoke assembly* forms the base of the compression head. It functions as a movable piston die to provide the crimping force.
- The *latch assembly* bridges the cam yoke across the end of the head. The latch nib in the center of the assembly is the stationary die.

The following procedure describes how to remove and replace the latch nibs.

⚠ WARNING

Installing dies in the tools with the hydraulic hoses connected can cause severe personal injury or equipment damage.

To prevent accidental start-up, always disconnect the hoses before installing dies.

OPERATION

1. If the hydraulic hoses are connected:
 - Turn the hydraulic system control valve OFF.
 - Disconnect first the hydraulic input (supply) hose, then the output (return) hose.
2. Clean the surfaces of the die holder to remove any dirt or grease.
3. Pull the pin out to release the latch.
4. Rotate the latch away from the head to provide access to the nib/nest die.
5. To release the nib/nest die, drive the roll pin out of the center of the latch.
6. Remove the nib/nest die by rotating it out and around the small pivot pin inside the latch.
7. Insert the new nib/nest die, rotating it around the pivot pin as in step 6. Make sure the nib/nest die is oriented so the notched side faces the pivot pin.
8. Press the nib/nest die firmly until it locks into place.
9. Drive the roll pin into the center of the latch to retain the nib/nest die.
10. Close the latch. Insert the latch pin.

HYDRAULIC HOSE CONNECTION

Make sure the hydraulic system control valve is in the OFF position when coupling or uncoupling the hoses. Failure to do so may result in damage to the quick couplers and cause overheating of the hydraulic system.

Before installing the hoses, wipe the fittings and the entire length of the hoses with a clean, dry lint-free cloth to remove any dirt or moisture. Dirty connections can contaminate the hydraulic fluid, causing rapid wear and early failure of internal parts.

Check the flow indicators (arrows) stamped on the couplers to ensure oil flows in the proper direction. The female coupler on the tool is the inlet coupler.

It is a good practice to connect the output (return) hose first and disconnect it last to minimize or avoid trapped pressure within the tool.

1. Connect the output hose to the OUT or T port on the tool.
2. Connect the input hose to the IN or P port.
3. Be sure all hose connections are tight.

DIE LOAD VERIFICATION

1. Use Anderson test slugs to verify the crimping force in the tool.

2. Connect the tool to an appropriate hydraulic power source. Follow the Hydraulic Hose Connection safety guidelines and instructions in this section. If possible, use the hydraulic power source you plan to use for crimping.
3. Position the test slug within the nibs.
4. Actuate the tool to squeeze the test slug.
5. Release the test slug and then measure it.
If the indicated value is low or high and the system pressure relief valve setting is greater than 1650 psi (114 bar), adjust the relief valve on the CT to get the correct die load.
6. When the value is within the acceptable range, turn the hydraulic system control valve OFF and disconnect the hoses from the tool.

OC/CC SETTING

Check the open-center/closed-center (OC/CC) setting on the tool. The current setting is easily determined by looking at the gap between the adapter and the cylinder, see Figure 2.

- Open Center: No gap
- Closed Center: Approximately 1/4-inch (6.4-mm) gap

If the setting is not correct for your hydraulic system, follow the instructions in this section, OC/CC Adjustment, to make the change.

CHECK POWER SOURCE

Using a calibrated flowmeter and pressure gauge, check the hydraulic power source at the tool's input port. Make sure the system maintains an operating flow in the range of 3–9 gpm/11–34 lpm within a pressure range of 1650–2000 psi /114–140 bar.

The hydraulic fluid temperature should be at least 80 °F/27 °C for this test.

CONNECT HOSES

1. Wipe all hose couplers with a clean, lint-free cloth before making connections.
2. Connect hoses from the hydraulic power source to the tool fittings or quick disconnects. It is good practice to connect the return hose first and disconnect it last to minimize or eliminate trapped pressure within the wrench.
3. Observe the flow indicators stamped on the main body assembly and the hose couplers to ensure that the flow is in the proper directions. The female couple on the tools "IN" port is the inlet (pressure) coupler.

OPERATION

NOTE:

If the uncoupled hoses are left in the sun, pressure increase within the hoses can make them difficult to connect. Whenever possible, connect the free ends of the hoses together.

TOOL RELIEF VALVE ADJUSTMENT

The relief valve on a universal pressure CT can be adjusted to increase or decrease the tool's crimping force. Standard CT's do not have a relief valve.

The crimping tools relief valve is located below the trigger guard. The relief valve on the hydraulic system is totally separate and has a different function.

1. Perform steps 1 through 5 under Die Load Verification.
2. If the load tester indication is within the acceptable range, the tools' relief valve on the hydraulic system is set correctly. If it is not, adjust the valve as follows:
 - a. Turn the hydraulic system control valve OFF.
 - b. Remove the plug from the end of the relief valve, below the trigger guard.
 - c. Using a hex wrench, turn the adjusting screw. Clockwise (CW) to increase pressure or Counterclockwise (CCW) to decrease pressure.
 - d. Replace the plug in the relief valve and retest. Repeat the adjustment if necessary.

TOOL OPERATION

Observe all safety precautions when operating the tool. Read Safety and Hydraulic System Requirements, before operating the tool for the first time.

CONDUCTOR PREPARATION

1. If the conductor is insulated, remove the insulation from the end of the conductor.

Use an insulation stripping tool. If a stripping tool is not available, carefully shave the insulation from the cable.

Be sure not to nick or cut the strands of the conductor.
2. Remove any oxide or foreign matter from the exposed conductor. A bright, shiny surface is required for a good connection. Do not wire-brush tin-plated copper conductors or tinned connectors.
3. Install the connector sleeve onto the conductor.

STARTUP

1. Clean the nibs on the tool. Remove all traces of lubrication from each tool nib before crimping.
2. Pull the ringed latch pin out of the latch. Rotate the latch away from the crimping head and then place the crimping head over the connector sleeve on the conductor. Close the latch and reinstall the ringed latch pin.
3. Move the hydraulic system control valve to the ON position.

WARNING

The crimping force between the dies in the tool head can cause severe personal injury.

Keep hands away from the die area when operating the tool.

4. Remove any trapped air from the tool by squeezing the trigger 4 or 5 times to advance and retract the piston nearly a full stroke.
5. Position the tool as follows:
 - a. **Connector sleeves**

Center the sleeve between all four nibs in the compression head. Place the sleeve so the nibs make the first crimp adjacent to the center-band mark.

Make sure the connector sleeve is carefully centered between all four nibs in the tool.
 - b. **H-Frame Connectors:**

Place the connector in the tool so the main groove is positioned between the top nib and either side nib. Make sure the positioning grooves mate with two of the nibs.
6. Squeeze the trigger to crimp the connector.

OPERATION

7. Release the trigger to retract the nibs.
8. Repeat the crimp as required.
9. After the last crimp, make sure the nibs in the crimping head are fully retracted
10. Pull out the latch pin and rotate the latch away from the crimping head.
11. Remove the tool by lifting it clear of the cable.

SHUTDOWN

1. Move the hydraulic system control valve to the OFF position.
2. Disconnect the hydraulic hoses from the tool: first the input (supply) hose, then the output (return) hose.
3. Insert plugs in the hose ends, couplers or tool ports, as applicable.
4. Wipe the tool thoroughly with a clean dry cloth.
5. Clean any foreign matter or joint compound from the die holder surfaces.

COLD WEATHER OPERATION

IMPORTANT

Use an oil with the recommended specification from the HTMA Requirement table. Using oil that is too viscous (thick) can damage the hydraulic system.

If the tool is to be used during cold weather, preheat the hydraulic fluid at low engine speed. When using the normally recommended fluids, fluid temperature should be at or above 50°F/10°C (400 ssu/82 centistokes) before use.

Damage to the hydraulic system or compression tool can result from use with fluid that is too viscous or too thick.

STORAGE

Replace any damaged or missing safety labels and tags before storing the tool. Clean, dry and lubricate moving parts before storage. Store in a clean, dry place.

TOOL PROTECTION & CARE

NOTICE

In addition to the Safety Precautions found in this manual, observe the following for equipment protection and care.

- Make sure all couplers are wiped clean before connection.
- The hydraulic circuit control valve must be in the “OFF” position when coupling or uncoupling hydraulic tools. Failure to do so may result in damage to the quick couplers and cause overheating of the hydraulic system.
- Always store the tool in a clean dry space, safe from damage or pilferage.
- Make sure the circuit PRESSURE hose (with male quick disconnect) is connected to the “IN” port. The circuit RETURN hose (with female quick disconnect) is connected to the opposite port. Do not reverse circuit flow. This can cause damage to internal seals.
- Always replace hoses, couplings and other parts with replacement parts recommended by Stanley Hydraulic Tools. Supply hoses must have a minimum working pressure rating of 2500 psi/172 bar.
- Do not exceed the rated flow. Refer to Specifications in this manual for correct flow rate. Rapid failure of the internal seals may result.
- Always keep critical tool markings, such as warning stickers and tags legible.
- Do not force a small tool to do the job of a large tool.
- Tool repair should be performed by experienced personnel only.
- Make certain that the recommended relief valves are installed in the pressure side of the system.
- Do not use the tool for applications for which it was not intended.

TROUBLESHOOTING

If symptoms of poor performance develop, the following chart can be used as a guide to correct the problem.

When diagnosing faults in operation of the crimping tool, always check that the hydraulic power source is supplying the correct hydraulic flow and pressure to the grinder as listed in the table. Use a flowmeter known to be accurate. Check the flow with the hydraulic oil temperature at least 80 °F/27 °C.

PROBLEM	CAUSE	SOLUTION
Tool does not operate.	Hydraulic hoses not connected properly.	Make sure hoses are connected and the couplers are tight.
	Hydraulic control valve OFF.	Turn the hydraulic system control valve ON.
	Hydraulic system not functioning.	Check hydraulic power unit for correct flow and pressure.
	Couplers or hoses blocked.	Remove obstruction.
	Pressure port check valve is installed in tool return port.	Install pressure port check valve in pressure port.
Tool operates in reverse (piston advances/retracts when trigger is squeezed).	Hoses connected to wrong ports on tool.	Connect input (supply) line to IN port. Connect output (return) line to OUT port.
Tool under-crimps. Die load less than 6 tons/5443 kg.	Hydraulic system pressure too low.	Check hydraulic power source for correct flow and pressure.
	Relief valve set too low.	Increase relief valve pressure.
	Dirt or obstruction between dies.	Remove obstruction. Clean die area.
	Piston seal worn or damaged.	Contact an authorized Stanley distributor.
	Improper die set for wire and connector.	Install proper die set.
Tool over-crimps. Die load more than 6 tons/5443 kg.	Hydraulic system pressure too high.	Check hydraulic power source for correct flow and pressure.
	Relief valve set too high.	Decrease relief valve pressure.
Trigger difficult to operate.	Hoses connected to wrong ports on tool.	Connect input (supply) line to IN port. Connect output (return) line to OUT port.
	Excessive back-pressure.	If back-pressure is greater than 250 psi/17 bar, clear the return line obstruction or restriction.
	Trigger guard bent and binding on spool in bore.	Repair or replace trigger assembly.

SPECIFICATIONS

Capacity	#10-750 MCM Aluminum and #10-500 MCM Copper
Crimping Force	6 tons @ 1650 psi / 5443 kg @ 114 bar
Pressure Range.....	1650 psi/114 bar
Flow Range	3-9 gpm / 11-34 lpm
Optimum Flow	8 gpm / 30 lpm
Porting	-8 SAE
Hose Whips & Couplers	No
Weight	13 lbs / 5.9 kg
Overall Length	20 inches / 50.8 cm
Overall Width	7.25 inches / 18 cm

CT06 PARTS ILLUSTRATION

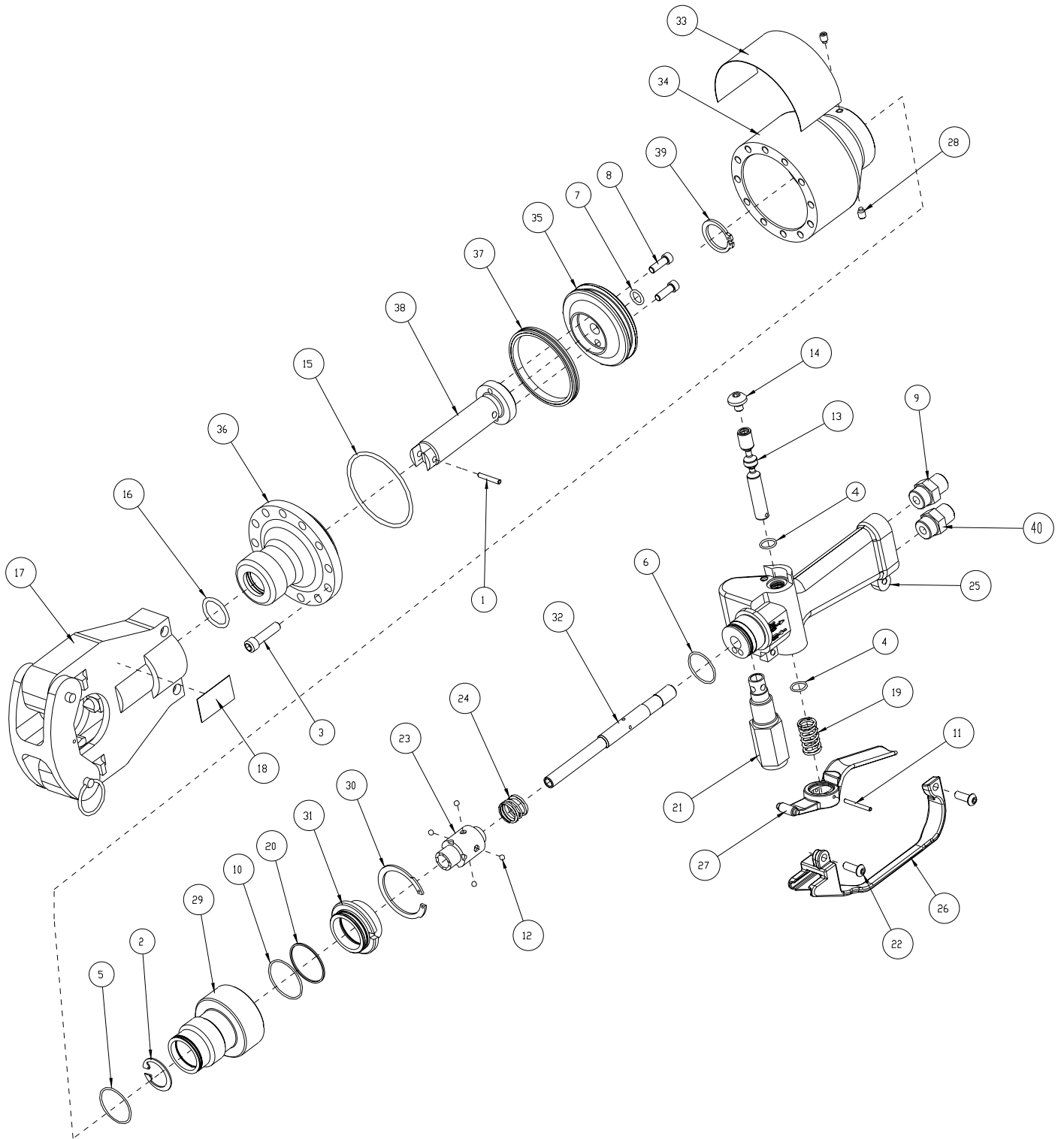

CT06 PARTS LIST

ITEM NO.	PART NO.	QTY	DESCRIPTION
1	00114	1	ROLL PIN
2	00118	1	RETAINING RING
3	00144	12	HSCHS
4	07626	2	O-RING ■
5	09330	1	O-RING ■
6	00294	1	O-RING ■
7	00360	1	O-RING ■
8	00769	2	HSCHS
9	00936	2	ADAPTER
10	01259	1	O-RING ■
11	01534	1	ROLL PIN
12	01608	4	STEEL BALL
13	01809	1	VALVE SPOOL
14	01812	1	VALVE SPOOL SCREW
15	04054	1	O-RING ■
16	04794	1	O-RING ■
17	67013	1	FLIP-TOP CRIMPING HEAD
18	07427	1	CAUTION STICKER
19	16556	1	SPRING
20	18050	1	BACK-UP RING ■
21	21424	1	RELIEF VALVE
22	22147	2	CAPSCREW
23	38622	1	VALVE SLEEVE
24	39925-1	1	COMPRESSION SPRING
25	39939	1	VALVE HANDLE
26	51182	1	TRIGGER GUARD
27	51183	1	TRIGGER
28	52534	2	SETSCREW
29	58439	1	ADAPTER
30	58440	1	RETAINING RING
31	58441	1	SLEEVE
32	58442	1	OIL TUBE
33	58500	1	COMBINED CT06 1650 PSI STICKER
34	58520	1	CYLINDER
35	58521	1	PISTON
36	58522	1	CYLINDER HEAD
37	58523	1	T-SEAL ■
38	58525	1	PUSH ROD
39	58594	1	RETAINER RING
40	67259	1	CHECK VALVE ASSY

ITEM NO.	PART NO.	QTY	DESCRIPTION
	58550	1	SEAL KIT (■ INDICATES PART IN SEAL KIT)

STANLEY®

Stanley Hydraulic Tools
3810 SE Naef Road
Milwaukie, Oregon
503-659-5660 / Fax 503-652-1780
www.stanleyhydraulics.com