

STANLEY®

DS12 HYDRAULIC UTILITY SAW



USER MANUAL Safety, Operation and Maintenance



© 2012 Stanley Black & Decker, Inc.
New Britain, CT 06053
U.S.A.
71069 2/2015 Ver. 9

DECLARATION OF CONFORMITY

DECLARATION OF CONFORMITY
ÜBEREINSTIMMUNGS-ERKLÄRUNG
DECLARATION DE CONFORMITE CEE
DECLARACION DE CONFORMIDAD
DICHIARAZIONE DI CONFORMITA

STANLEY.
Hydraulic Tools
CE

I, the undersigned:
Ich, der Unterzeichnende:
Je soussigné:
El abajo firmante:
Io sottoscritto:

Weisbeck, Andy

Surname and First names/Familiennamen und Vornamen/Nom et prénom/Nombre y apellido/Cognome e nome

hereby declare that the equipment specified hereunder:
bestätige hiermit, daß erklaren Produkt genannten Werk oder Gerät:
déclare que l'équipement visé ci-dessous:
Por la presente declaro que el equipo se especifica a continuación:
Dichiaro che le apparecchiature specificate di seguito:

- Category: **Utility Chainsaw, Hydraulic**
Kategorie:
Catégorie:
Categoria:
Categoria:
- Make/Marke/Marque/Marca/Marca **Stanley**
- Type/Typ/Type/Tipo/Tipo: **DS1231801**
- Serial number of equipment:
Seriennummer des Geräts:
Numéro de série de l'équipement:
Numero de serie del equipo:
Matricola dell'attrezzatura:
All

Has been manufactured in conformity with
Wurde hergestellt in Übereinstimmung mit
Est fabriqué conformément
Ha sido fabricado de acuerdo con
E' stata costruita in conformità con

| Directive/Standards Richtlinie/Standards Directives/Normes Directriz/Los Normas Direttiva/Norme | No. Nr Numéro No n. | Approved body Prüfung durch Organisme agréé Aprobado Collaudato |
|---|---------------------------------|---|
| EN ISO | 12100:2010 | Self |
| EN ISO | 3744:2010 | Self |
| ISO | 20643:2005 | Self |
| ISO | 10726:1992 | Self |
| Machinery Directive | 2006/42/EC:2006 | Self |

- Special Provisions: **None**
Spezielle Bestimmungen:
Dispositions particulières:
Provisiones especiales:
Disposizioni speciali:
- Representative in the Union: **Patrick Vervier, Stanley Dubuis 17-19, rue Jules Berthonneau-BP 3406 41034 Blois Cedex, France.**
Vertreter in der Union/Représentant dans l'union/Representante en la Union/Rappresentante presso l'Unione

Done at/Ort/Fait à/Dado en/Fatto a Stanley Hydraulic Tools, Milwaukie, Oregon USA Date/Datum/le/Fecha/Data 1-4-11

Signature/Unterschrift/Signature/Firma/Firma

Andy Weisbeck

Position/Position/Fonction/Cargo/Posizione Director of Product Development

TABLE OF CONTENTS

| | |
|---|----|
| DECLARATION OF CONFORMITY | 2 |
| SAFETY SYMBOLS | 4 |
| SAFETY PRECAUTIONS..... | 5 |
| TOOL STICKERS & TAGS | 7 |
| HOSE TYPES..... | 8 |
| HOSE RECOMMENDATIONS | 9 |
| FIGURE 1. TYPICAL HOSE CONNECTIONS | 9 |
| HTMA REQUIREMENTS..... | 10 |
| OPERATION..... | 11 |
| FIGURE 2. PROPER CHAIN TENSION | 11 |
| FIGURE 3. MAXIMUM CHAIN CLEARANCE | 12 |
| FIGURE 4. WHEN TO TENSION | 12 |
| FIGURE 5. HOW TO TENSION | 12 |
| FIGURE 6. CHECKING FOR PROPER TENSION | 12 |
| FIGURE 7. TOP DOWN CUT..... | 14 |
| FIGURE 8. BOTTOM UP CUT | 14 |
| SAW BAR MAINTENANCE | 15 |
| TROUBLESHOOTING | 16 |
| SPECIFICATIONS | 18 |
| ACCESSORIES..... | 18 |
| DS12 PARTS ILLUSTRATION | 19 |
| DS12 PARTS LIST | 20 |
| DS12 MOTOR ILLUSTRATION & PARTS LIST | 21 |
| DS12 BAR, CHAIN & HOSES PARTS LIST..... | 22 |
| SAW CLAMP INSTRUCTIONS | 23 |

IMPORTANT

To fill out a Product Warranty Validation form, and for information on your warranty, visit Stanleyhydraulics.com and select the Company tab, Warranty.
(NOTE: The warranty Validation record must be submitted to validate the warranty).

SERVICING: This manual contains safety, operation, and routine maintenance instructions. Stanley Hydraulic Tools recommends that servicing of hydraulic tools, other than routine maintenance, must be performed by an authorized and certified dealer. Please read the following warning.

⚠ WARNING

SERIOUS INJURY OR DEATH COULD RESULT FROM THE IMPROPER REPAIR OR SERVICE OF THIS TOOL.

REPAIRS AND / OR SERVICE TO THIS TOOL MUST ONLY BE DONE BY AN AUTHORIZED AND CERTIFIED DEALER.

For the nearest authorized and certified dealer, call Stanley Hydraulic Tools at the number listed on the back of this manual and ask for a Customer Service Representative.

SAFETY PRECAUTIONS

Tool operators and maintenance personnel must always comply with the safety precautions given in this manual and on the stickers and tags attached to the tool and hose.

These safety precautions are given for your safety. Review them carefully before operating the tool and before performing general maintenance or repairs.

Supervising personnel should develop additional precautions relating to the specific work area and local safety regulations. If so, place the added precautions in the space provided in this manual.

The DS12 Utility Saw will provide safe and dependable service if operated in accordance with the instructions given in this manual. Read and understand this manual and any stickers and tags attached to the tool and hoses before operation. Failure to do so could result in personal injury or equipment damage.



- Establish a training program for all operators to ensure safe operation.
- The operator must be familiar with all prohibited work areas such as excessive slopes and dangerous terrain conditions.
- Do not operate the chain saw unless thoroughly trained or under the supervision of an instructor.
- Always wear safety equipment such as goggles, ear, breathing, head protection, leg protection, gloves, snug fitting clothing and safety shoes at all times when operating the chain saw.
- Do not overreach. Maintain proper footing and balance at all times.
- Do not inspect or clean the chain saw while the hydraulic power source is connected. Accidental engagement of the chain saw can cause serious injury.
- Always connect hoses to the chain saw hose couplers before energizing the hydraulic power source. Make sure all hose connections are tight.
- Do not operate the chain saw at fluid temperatures above 140 °F/60 °C. Operation at higher temperatures can cause higher than normal temperatures at the chain saw which can result in operator discomfort.
- Do not rely exclusively upon the safety devices built into the chain saw. As a chain saw user, several steps must be taken to keep your cutting jobs free from accident or injury:
 - a. With a basic understanding of kickbacks, you can reduce or eliminate the element of surprise. Sudden surprise contributes to accidents.
 - b. Keep a good firm grip on the chain saw with both hands, the right hand on the rear handle and the left hand on the front handle when operating the chain saw. Use a firm grip with thumbs and fingers encircling the chain saw handles. A firm grip helps reduce kickbacks and maintains control of the chain saw. Do not let go.
 - c. Make sure the area in which you are cutting is free of obstructions.
 - d. Cut at rated operating speeds (gpm).
 - e. Do not overreach or cut above shoulder height.
 - f. Only use replacement bars and chains specified by Stanley or the equivalent.
- Make sure the chain guard is in place before operating the chain saw.
- Remove or control the water slurry to prevent yourself or others from slipping while cutting.
- Provide adequate ventilation in closed areas when operating a gas or diesel hydraulic power source.
- Do not operate a hydraulic power source or a hydraulic diamond saw in an explosive atmosphere.
- **Warning:** Use of this tool on certain materials during demolition could generate dust potentially containing a variety of hazardous substances such as asbestos, silica or lead. Inhalation of dust containing these or other hazardous substances could result in serious injury, cancer or death. Protect yourself and those around you. Research and understand the materials you are cutting. Follow correct safety procedures and comply with all applicable national, state or provisional health and safety regulations relating to them, including, if appropriate arranging for the safe disposal of the materials by a qualified person.

SAFETY PRECAUTIONS

- Always be well rested and mentally alert before operating the chain saw.
- Do not allow bystanders near the chain saw when starting or cutting.
- Do not start cutting until you have a clear work area and secure footing.
- Keep all parts of the body away from the chain saw during operation, including loose clothing and long hair.
- Carry the chain saw with the tool de-energized and the bar and chain to the rear of your body.
- Do not operate a chain saw that is damaged, improperly adjusted, or not completely and securely assembled. Make sure the chain stops moving when the control trigger is released.
- Keep the handle dry, clean and free of hydraulic fluid.
- Do not use the chain saw near energized transmission lines.
- Turn off the power source or move the hydraulic control valve to neutral before setting the chain saw down.
- Use a guide bar scabbard when transporting the chain saw.
- Know the location of buried or covered utilities before starting work.
- To avoid personal injury or equipment damage, all chain saw repair, maintenance and service must only be performed by authorized and properly trained personnel.
- Make sure the chain breaker and rivet spinner are securely mounted on flat, clean work surfaces. Check the mounting screws/bolts often.
- Check all chain breaker and rivet spinner components regularly for wear and general condition.
- Avoid contact with the saw bar rails as they can become very sharp during use.
- Provide adequate lighting when operating the saw in a darkened area or at night.
- Always keep critical tool markings, such as labels and warning stickers legible. Always replace stickers and decals that have become worn or damaged.
- Be observant of hydraulic and water hoses that lay about the work area, especially in trenches where they can be hidden from view due to liquids that have accumulated within the space.
- Keep all parts of the body away from the cleats that are attached to the saw, as these are sharp and can be a puncture hazard.
- Improper handling, use, or maintenance can result in an oil leak or burst. Do not contact an oil leak as high pressure oil can cause injection into the body.
- Never stand in the path of the discharge, as ejection of material from the work piece can cause personal injury.
- Never use the saw in a potentially explosive atmosphere.
- **WARNING: Hydraulic fluid under pressure could cause skin injection injury. If you are injured by hydraulic fluid, get medical attention immediately.**

TOOL STICKERS & TAGS



28409
Composite Safety Decal



71071
Name Tag



11207
Type D Circuit
Sticker

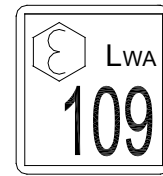

11212
Sound Power
Level Sticker

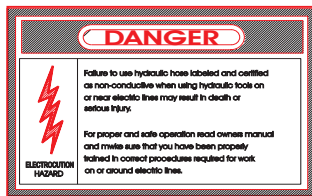

12412
Electrical Warning Sticker

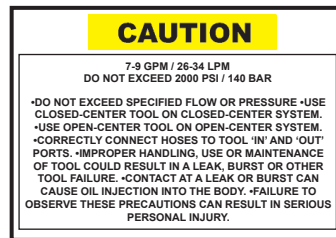

03786
GPM Sticker
7-9 2000 PSI

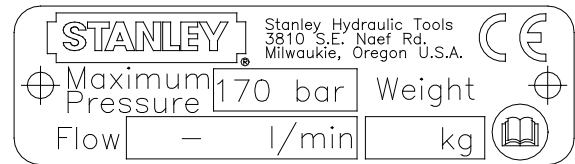

71073
CE Tool Plate

NOTE:
THE INFORMATION LISTED ON THE STICKERS SHOWN, MUST BE LEGIBLE AT ALL TIMES.
REPLACE DECALS IF THEY BECOME WORN OR DAMAGED. REPLACEMENTS ARE AVAILABLE FROM YOUR LOCAL STANLEY DISTRIBUTOR.

The safety tag (P/N 15875) at right is attached to the tool when shipped from the factory. Read and understand the safety instructions listed on this tag before removal. We suggest you retain this tag and attach it to the tool when not in use.

D A N G E R

1. FAILURE TO USE HYDRAULIC HOSE LABELED AND CERTIFIED AS NON-CONDUCTIVE WHEN USING HYDRAULIC TOOLS ON OR NEAR ELECTRICAL LINES MAY RESULT IN DEATH OR SERIOUS INJURY.
BEFORE USING HOSE LABELED AND CERTIFIED AS NON-CONDUCTIVE ON OR NEAR ELECTRICAL LINES BE SURE THE HOSE IS MAINTAINED AS NON-CONDUCTIVE. THE HOSE SHOULD BE REGULARLY TESTED FOR ELECTRIC CURRENT LEAKAGE IN ACCORDANCE WITH YOUR SAFETY DEPARTMENT INSTRUCTIONS.
2. A HYDRAULIC LEAK OR BURST MAY CAUSE OIL INJECTION INTO THE BODY OR CAUSE OTHER SEVERE PERSONAL INJURY.
 - A. **DO NOT EXCEED SPECIFIED FLOW AND PRESSURE FOR THIS TOOL. EXCESS FLOW OR PRESSURE MAY CAUSE A LEAK OR BURST.**
 - B. **DO NOT EXCEED RATED WORKING PRESSURE OF HYDRAULIC HOSE USED WITH THIS TOOL. EXCESS PRESSURE MAY CAUSE A LEAK OR BURST.**
 - C. CHECK TOOL HOSE COUPLERS AND CONNECTORS DAILY FOR LEAKS. **DO NOT FEEL FOR LEAKS WITH YOUR HANDS. CONTACT WITH A LEAK MAY RESULT IN SEVERE PERSONAL INJURY.**

I M P O R T A N T

READ OPERATION MANUAL AND SAFETY INSTRUCTIONS FOR THIS TOOL BEFORE USING IT.

USE ONLY PARTS AND REPAIR PROCEDURES APPROVED BY STANLEY AND DESCRIBED IN THE OPERATION MANUAL.

TAG TO BE REMOVED ONLY BY TOOL OPERATOR.

SEE OTHER SIDE

D A N G E R

- D. **DO NOT LIFT OR CARRY TOOL BY THE HOSES. DO NOT ABUSE HOSE. DO NOT USE KINKED, TORN OR DAMAGED HOSE.**
3. **MAKE SURE HYDRAULIC HOSES ARE PROPERLY CONNECTED TO THE TOOL BEFORE PRESSURING SYSTEM. SYSTEM PRESSURE HOSE MUST ALWAYS BE CONNECTED TO TOOL "IN" PORT. SYSTEM RETURN HOSE MUST ALWAYS BE CONNECTED TO TOOL "OUT" PORT. REVERSING CONNECTIONS MAY CAUSE REVERSE TOOL OPERATION WHICH CAN RESULT IN SEVERE PERSONAL INJURY.**
4. **DO NOT CONNECT OPEN-CENTER TOOLS TO CLOSED-CENTER HYDRAULIC SYSTEMS. THIS MAY RESULT IN LOSS OF OTHER HYDRAULIC FUNCTIONS POWERED BY THE SAME SYSTEM AND/OR SEVERE PERSONAL INJURY.**
5. **BYSTANDERS MAY BE INJURED IN YOUR WORK AREA. KEEP BYSTANDERS CLEAR OF YOUR WORK AREA.**
6. **WEAR HEARING, EYE, FOOT, HAND AND HEAD PROTECTION.**
7. **TO AVOID PERSONAL INJURY OR EQUIPMENT DAMAGE, ALL TOOL REPAIR MAINTENANCE AND SERVICE MUST ONLY BE PERFORMED BY AUTHORIZED AND PROPERLY TRAINED PERSONNEL.**

I M P O R T A N T

READ OPERATION MANUAL AND SAFETY INSTRUCTIONS FOR THIS TOOL BEFORE USING IT.

USE ONLY PARTS AND REPAIR PROCEDURES APPROVED BY STANLEY AND DESCRIBED IN THE OPERATION MANUAL.

TAG TO BE REMOVED ONLY BY TOOL OPERATOR.

SEE OTHER SIDE

SAFETY TAG P/N 15875 (Shown smaller than actual size)

HOSE TYPES

The rated working pressure of the hydraulic hose must be equal to or higher than the relief valve setting on the hydraulic system. There are three types of hydraulic hose that meet this requirement and are authorized for use with Stanley Hydraulic Tools. They are:

Certified non-conductive — constructed of thermoplastic or synthetic rubber inner tube, synthetic fiber braid reinforcement, and weather resistant thermoplastic or synthetic rubber cover. *Hose labeled **certified non-conductive** is the only hose authorized for use near electrical conductors.*

Wire-braided (conductive) — constructed of synthetic rubber inner tube, single or double wire braid reinforcement, and weather resistant synthetic rubber cover. *This hose is **conductive** and must never be used near electrical conductors.*

Fabric-braided (not certified or labeled non-conductive) — constructed of thermoplastic or synthetic rubber inner tube, synthetic fiber braid reinforcement, and weather resistant thermoplastic or synthetic rubber cover. *This hose is **not certified non-conductive** and must never be used near electrical conductors.*

HOSE SAFETY TAGS

To help ensure your safety, the following DANGER tags are attached to all hose purchased from Stanley Hydraulic Tools. DO NOT REMOVE THESE TAGS.

If the information on a tag is illegible because of wear or damage, replace the tag immediately. A new tag may be obtained from your Stanley Distributor.

THE TAG SHOWN BELOW IS ATTACHED TO “CERTIFIED NON-CONDUCTIVE” HOSE

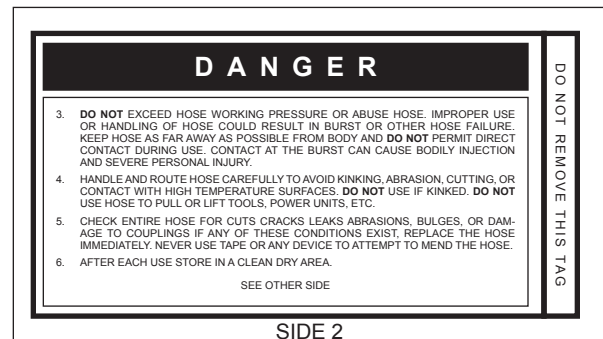
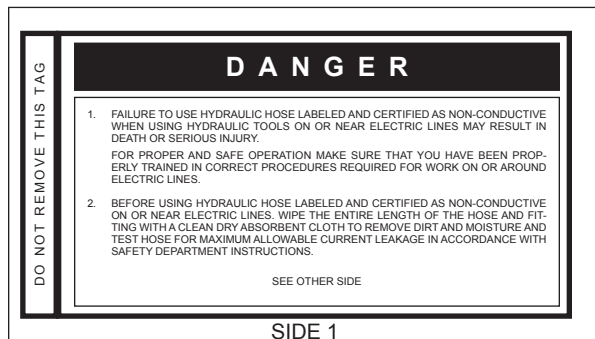

(Shown smaller than actual size)

THE TAG SHOWN BELOW IS ATTACHED TO “CONDUCTIVE” HOSE.

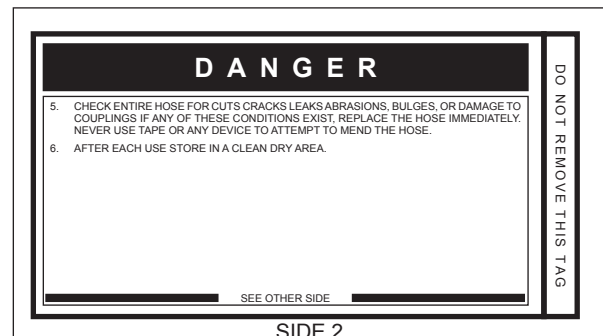
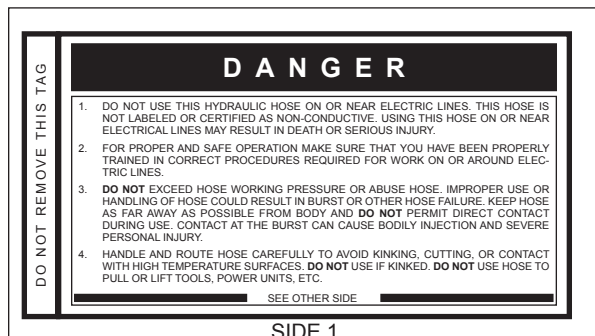

(Shown smaller than actual size)

HOSE RECOMMENDATIONS

Tool to Hydraulic Circuit Hose Recommendations

The chart to the right shows recommended minimum hose diameters for various hose lengths based on gallons per minute (gpm)/liters per minute (lpm). These recommendations are intended to keep return line pressure (back pressure) to a minimum acceptable level to ensure maximum tool performance.

This chart is intended to be used for hydraulic tool applications only based on Stanley Hydraulic Tools tool operating requirements and should not be used for any other applications.

All hydraulic hose must have at least a rated minimum working pressure equal to the maximum hydraulic system relief valve setting.

All hydraulic hose must meet or exceed specifications as set forth by SAE J517.

| Oil Flow | | Hose Lengths | | Inside Diameter | | USE (Press/Return) | Min. Working Pressure | |
|---|-------|--------------|-----------|-----------------|------|-----------------------|-----------------------|-----|
| GPM | LPM | FEET | METERS | INCH | MM | | PSI | BAR |
| Certified Non-Conductive Hose - Fiber Braid - for Utility Bucket Trucks | | | | | | | | |
| 4-9 | 15-34 | up to 10 | up to 3 | 3/8 | 10 | Both | 2250 | 155 |
| Conductive Hose - Wire Braid or Fiber Braid -DO NOT USE NEAR ELECTRICAL CONDUCTORS | | | | | | | | |
| 4-6 | 15-23 | up to 25 | up to 7.5 | 3/8 | 10 | Both | 2500 | 175 |
| 4-6 | 15-23 | 26-100 | 7.5-30 | 1/2 | 13 | Both | 2500 | 175 |
| 5-10.5 | 19-40 | up to 50 | up to 15 | 1/2 | 13 | Both | 2500 | 175 |
| 5-10.5 | 19-40 | 51-100 | 15-30 | 5/8 | 16 | Both | 2500 | 175 |
| 5-10.5 | 19-40 | 100-300 | 30-90 | 5/8 | 16 | Pressure | 2500 | 175 |
| 10-13 | 38-49 | up to 50 | up to 15 | 3/4 | 19 | Return | 2500 | 175 |
| 10-13 | 38-49 | 51-100 | 15-30 | 5/8 | 16 | Both | 2500 | 175 |
| 10-13 | 38-49 | 100-200 | 30-60 | 3/4 | 19 | Pressure | 2500 | 175 |
| 13-16 | 49-60 | up to 25 | up to 8 | 5/8 | 16 | Pressure | 2500 | 175 |
| 13-16 | 49-60 | 26-100 | 8-30 | 3/4 | 19 | Return | 2500 | 175 |
| 13-16 | 49-60 | 26-100 | 8-30 | 1 | 25.4 | Return | 2500 | 175 |

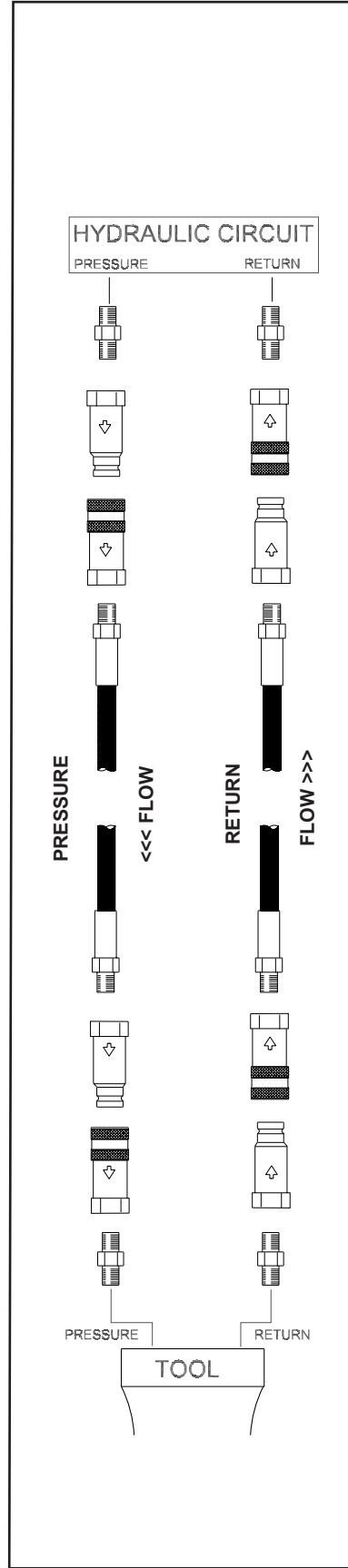

Figure 1. Typical Hose Connections

HTMA / EHTMA REQUIREMENTS

HTMA / EHTMA REQUIREMENTS

HTMA





HYDRAULIC SYSTEM REQUIREMENTS

TOOL TYPE

| | TYPE I | TYPE II | TYPE RR | TYPE III |
|--|---------------------------------------|---------------------------------------|---------------------------------------|---------------------------------------|
| Flow Range | 4-6 gpm (15-23 lpm) | 7-9 gpm (26-34 lpm) | 9-10.5 gpm (34-40 lpm) | 11-13 gpm (42-49 lpm) |
| Nominal Operating Pressure (at the power supply outlet) | 1500 psi (103 bar) | 1500 psi (103 bar) | 1500 psi (103 bar) | 1500 psi (103 bar) |
| System relief valve setting (at the power supply outlet) | 2100-2250 psi (145-155 bar) | 2100-2250 psi (145-155 bar) | 2200-2300 psi (152-159 bar) | 2100-2250 psi (145-155 bar) |
| Maximum back pressure (at tool end of the return hose) | 250 psi (17 bar) | 250 psi (17 bar) | 250 psi (17 bar) | 250 psi (17 bar) |
| Measured at a max. fluid viscosity of: (at min. operating temperature) | 400 ssu* (82 centistokes) | 400 ssu* (82 centistokes) | 400 ssu* (82 centistokes) | 400 ssu* (82 centistokes) |
| Temperature: Sufficient heat rejection capacity to limit max. fluid temperature to: (at max. expected ambient temperature) | 140° F (60° C) | 140° F (60° C) | 140° F (60° C) | 140° F (60° C) |
| Min. cooling capacity at a temperature difference of between ambient and fluid temps | 3 hp (2.24 kW) 40° F (22° C) | 5 hp (3.73 kW) 40° F (22° C) | 6 hp (5.22 kW) 40° F (22° C) | 7 hp (4.47 kW) 40° F (22° C) |
| NOTE: Do not operate the tool at oil temperatures above 140° F (60° C). Operation at higher temperatures can cause operator discomfort at the tool. | | | | |
| Filter Min. full-flow filtration Sized for flow of at least: (For cold temp. startup and max. dirt-holding capacity) | 25 microns 30 gpm (114 lpm) | 25 microns 30 gpm (114 lpm) | 25 microns 30 gpm (114 lpm) | 25 microns 30 gpm (114 lpm) |
| Hydraulic fluid Petroleum based (premium grade, anti-wear, non-conductive) Viscosity (at min. and max. operating temps) | 100-400 ssu* | 100-400 ssu* (20-82 centistokes) | 100-400 ssu* | 100-400 ssu* |
| NOTE: When choosing hydraulic fluid, the expected oil temperature extremes that will be experienced in service determine the most suitable temperature viscosity characteristics. Hydraulic fluids with a viscosity index over 140 will meet the requirements over a wide range of operating temperatures. | | | | |
| *SSU = Saybolt Seconds Universal | | | | |

EHTMA HYDRAULIC SYSTEM REQUIREMENTS

CLASSIFICATION

| |  |  |  |  |  |
|---|---|---|--|---|---|
| Flow Range | 3.5-4.3 gpm (13.5-16.5 lpm) | 4.7-5.8 gpm (18-22 lpm) | 7.1-8.7 gpm (27-33 lpm) | 9.5-11.6 gpm (36-44 lpm) | 11.8-14.5 gpm (45-55 lpm) |
| Nominal Operating Pressure (at the power supply outlet) | 1870 psi (129 bar) | 1500 psi (103 bar) | 1500 psi (103 bar) | 1500 psi (103 bar) | 1500 psi (103 bar) |
| System relief valve setting (at the power supply outlet) | 2495 psi (172 bar) | 2000 psi (138 bar) | 2000 psi (138 bar) | 2000 psi (138 bar) | 2000 psi (138 bar) |

NOTE: These are general hydraulic system requirements. See tool specification page for tool specific requirements

OPERATION

PRE-OPERATION PROCEDURES

CHECK THE POWER SOURCE

1. Using a calibrated flow meter and pressure gauge, make sure the hydraulic power source develops a flow of 7–9 gpm/26–34 lpm at 2000 psi/140 bar.
2. Make certain that the power source is equipped with a relief valve set to open at 2100–2250 psi/145–155 bar.
3. Make certain that the power source return pressure does not exceed 250 psi/17 bar.

CONNECT HYDRAULIC HOSES

1. Wipe all hose couplers with a clean lint-free cloth before making connections. If necessary, use a light-weight penetrating oil in a spray can to clean the hose couplers before each connection.
2. Connect the hoses from the hydraulic power source to the chain saw fittings or quick disconnects. It is a good practice to connect return hoses first and disconnect them last to minimize or avoid trapped pressure within the chain saw.
3. Observe the arrow on the couplers to ensure that the flow is in the proper direction. The female coupler on the chain saw is the inlet (pressure) coupler.
4. Move the hydraulic circuit control valve to the **ON** position to operate the chain saw.

NOTE:

If uncoupled hoses are left in the sun, pressure increase inside the hoses might make them difficult to connect. Whenever possible, connect the free ends of the hoses together.

CONNECTING TO A WATER SUPPLY

1. Using a standard garden hose, connect the DS12 to a city or auxiliary water supply.
2. If you plan on operating the chain saw in freezing weather, make sure you purge all the water from the system after each use.

CHAIN TENSIONING AND BAR ADJUSTMENT

IMPORTANT

A properly tensioned chain will optimize cutting performance. The tensioning rule of thumb for the utility cutting chain saw is that a properly tensioned chain must not be bowstring tight and can be pulled freely around the guide bar by hand easily without binding. Caution should be used when adjusting these chains as the bar rail can become very sharp. Lift the chain away from the bar rail when rotating and use extreme caution.

NOTE:

The chain on the utility saw is non-directional and may be installed to travel either direction.

PROPER CHAIN TENSION

Check the chain tension often during operation, especially during the first 1/2 hour when using a new chain. Adjust the chain accordingly when it becomes loose.

If the chain is too loose, it could come off the bar, or it will allow the drive sprocket to spin without turning the chain, which can chew up the chain drive links. If the chain is too tight, a lot of the saw's power goes into turning the chain rather than into the cut. In extreme over-tightened cases, the saw may not be able to turn the chain at all. In addition, damage can occur to the bar nose and premature stretch may occur.

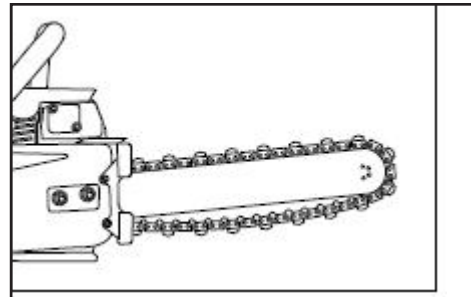

Figure 2. Proper Chain Tension

HOW TO CHECK

Before cutting, check for proper tension by pulling the chain around the bar by hand. If you cannot easily pull by hand, the chain is too tight and needs to be loosened.

OPERATION

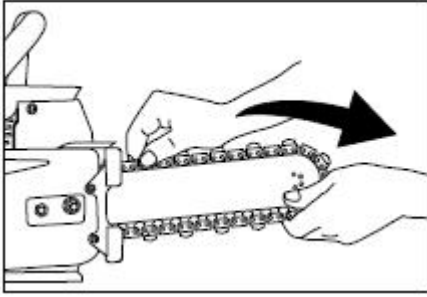

Figure 3. Maximum Chain Clearance

WHEN TO TENSION

All chains have a tendency to stretch when used. Diamond chains stretch more than wood cutting chains because of the abrasive materials they are cutting. When a chain stretches to a point where the drive links are hanging approximately 1/2 in–3/4 in (12–18 mm) below the bar, it's time to tension the chain.

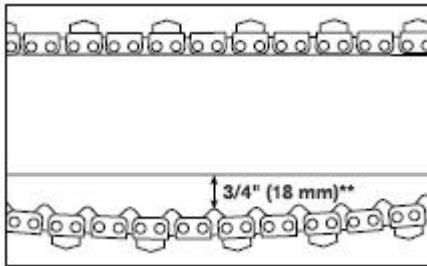

Figure 4. When to Tension

HOW TO TENSION

To tension the chain, first loosen the side cover nuts, then while holding the nose of the bar up, use a screw driver to turn the tensioning screw clockwise until the chain drive links hanging below the bar are just beginning to enter the bar groove. Continue to hold up on the nose of the bar and firmly tighten the side cover nuts, (20 ft-lbs, 27 Nm). And remember, it's the side cover nuts that hold the bar in position.

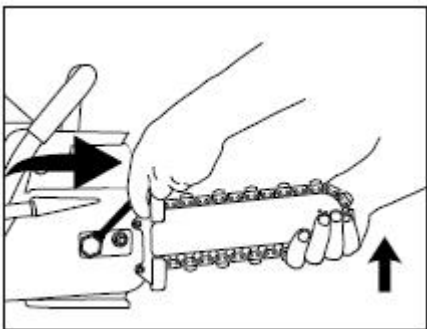

Figure 5. How to Tension

NOTE:

Make sure the bar attaching nuts are fully tightened and the chain guard is in place.

HOW TO PREVENT CHAIN TENSIONER BREAKAGE

Do not attempt to adjust the tensioner without first loosening the side cover nuts. Do not use the saw without making sure the side cover nuts are tight. If the side cover nuts are not tight, the bar can slip backwards during cutting and break the tensioner pin.

ADDITIONAL INFORMATION

Utility chain saws operate with looser chain tension than wood chain saws. It is common, on the utility chain saw to have the drive links hang completely out of the bar. Wood cutting chain saws use oil to lubricate the chain. The oil makes the chain very slippery and allows the drive links to fully nest between the teeth of the drive sprocket. The utility cutting chain saws require water for cooling and flushing the cut. Water is not as good as oil as a lubricant. Also, there are cutting particles mixed in with the water. As a result, sometimes the drive links do not nest properly on the drive sprocket. When this happens, the chain acts like it got tighter. There seems to be “tight” spots and “loose” spots as you pull the chain around the bar. If you tension when the chain is in one of the loose spots, it will be too tight at some point in its rotation around the bar. Rotating the chain completely around the bar by hand will let you know you have the chain properly tensioned.

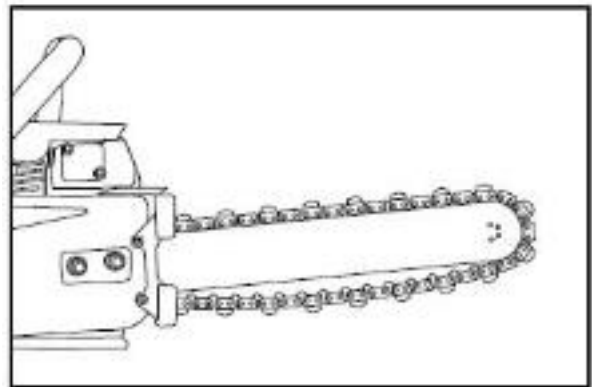

Figure 6. Checking for Proper Tension

ADDITIONAL TENSIONING TIPS

1. To reduce chain stretch and tensioning downtime, use 20 PSI (1.5 bar) or greater water pressure.
2. Oil the chain at the end of the day to prevent rust but be careful not to over tension in this condition.

OPERATION

- When pulling the chain around the bar by hand, be careful not to touch the bar with thumb or forefinger. **The bar rails can be very sharp.** Using leather gloves grab only the diamond segments to pull the chain.
- Always turn the hydraulic power source off before tensioning the chain.

CHECK THE WATER SUPPLY

IMPORTANT

Chain and bar damage will occur if the chain saw operates without the proper water supply.

- Always have water running before starting the chain saw.
- Recommended water flow 4 gpm/15 lpm at 50 psi/3.5 bar (2 gpm/7.5 lpm at 20 psi/1.3 bar minimum).

PRE-CUT CHECKLIST

- If using the clamp make sure it is securely fastened before attaching the saw, tighten clamp nut with wrench.
- Proper Chain tension: Bottom tip of drive link hangs even with bottom of bar.
- Ensure proper water flow and hydraulic supply to power unit.
- Ensure cut can be made clear of dirt contact.
- Protective clothing/protection in place.
- Mark cut on pipe.
- Block pipe from shifting, support weight of pipe.

WARNING

Before cutting make sure the material being cut is properly supported from falling or shifting.

OPERATING PROCEDURES

NEW SAW CHAIN BREAK-IN

- Always make sure the bar and sprocket are in good condition.
- Turn on the water supply.
- Operate the chain saw for two minutes (away from

the intended cut) and then check the chain tension.

- Adjust accordingly using the procedures contained in Chain Tensioning and Bar Adjustments section of this manual.

CUTTING TIPS

If using pipe clamp (Applicable for 4"–12", recommended for 8"–12").

- Place clamp around top of pipe, hand tighten adjustment nut.
- Position saw on pipe for top down or bottom up (recommended) cut and slide saw clamp mount through receiver hole at top of clamp, secure with snap pin.
- Slide clamp/saw assembly around pipe to optimum cutting position and tighten clamp nut with wrench.
- Ensure saw is positioned to allow handle to pivot during cut unobstructed, and ensure saw tip doesn't contact dirt.

CAUTION

When the saw cut is complete be watchful of sharp edges around the material that has been cut.

CUTTING FREE-HAND OR WITH PIPE CLAMP

WARNING

When exiting the cut, avoid applying high feed loads as unexpected movement of the saw may result. Using both hands, maintain firm control of the tool throughout the entire cut.

- Position saw to avoid pinching the bar or chain as pipe is cut, support pipe from top and side to prevent cut pipe from injuring operator.
- Hold saw so chain isn't in contact with pipe, start water and activate saw to recommended flow rate, press chain against pipe slowly, apply pressure to cut through pipe.
- Pressure can be applied to cut until saw starts to lug, if need be back off on the cutting pressure to maintain a good cutting speed.
- If cut in a 12" pipe exceeds 5 minutes, cut pulls to one side, or diamond coating is gone, chain may need replacement.

OPERATION

PLAN THE CUT

1. Plan your cuts to prevent injury to yourself and to keep from pinching the saw bar and chain as a result of falling pieces of iron pipe.
2. Outline the material being cut with a permanent marker for a visual guide (especially when cutting free hand).
3. Know what kind of material you are cutting.

TYPES OF CUTS

The DS12 can be operated not only using the pipe clamp but also make free-hand cuts, any size pipe can be cut free hand.

UTILITY CHAIN SAW CUTS

- Ductile Iron Pipe
- Insituform Pipe Lining
- PVC Pipe
- Copper Pipe
- Steel Roofing Material
- HDPE Pipe
- Roofing Shingles
- CMU Concrete Block
- Non Reinforced Concrete
- Roofing Tile
- Lumber
- Masonry

1. When using the pipe clamp with a 15-inch bar the cut capacity is 4" to 10".
2. When using the pipe clamp with a 18-inch bar the cut capacity is 4" to 12".
3. Do not use a cutting force in excess of 45 lbs/20 kg. Excessive force causes the chain to slow down or stall and causes premature wear of the saw bar and chain.
4. Always maintain a high chain speed. High chain speeds produce the best results.
5. Avoid aggressive/heavy forces. Aggressive force can causes premature bar and chain wear.

COLD WEATHER OPERATION

If the saw is to be used during cold weather, preheat the hydraulic fluid at low power source speed. When using the normally recommended fluids, fluid should be at or above 50 °F/10 °C (400 ssu/82 centistokes) before use.

Damage to the hydraulic system or chain saw can result from use with fluid that is too viscous or thick.



Figure 7. Top down Cut



Figure 8. Bottom up Cut

SAW BAR MAINTENANCE

GENERAL MAINTENANCE TIPS

Several simple maintenance tasks which, if performed, can keep a chain saw operating at a high level of efficiency. Routine maintenance also keeps replacement costs down on the parts of the chain saw, which occasionally wear out.

If any chain saw disassembly is required, refer to the Service Manual.

SAW BAR RAIL

A quick check can be made to determine if saw bar rail or chain segment wear exists. Figure 7 shows a worn saw bar rail.

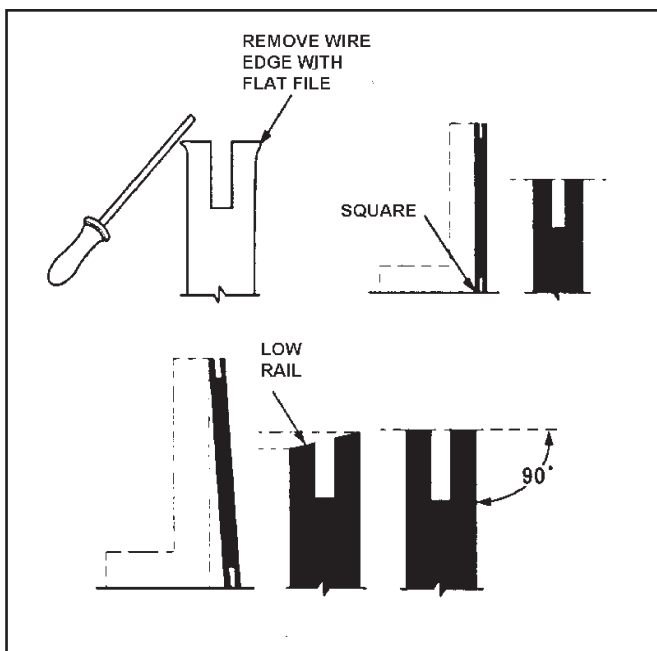

Figure 7. Rail Wear

If the saw bar rails are worn, use a flat file and dress each one until it is flat and square with the side of the saw bar (Figure 7).

Also make sure the saw bar is perfectly straight. If bows or bends are present in the saw bar, it must be replaced before dressing any rail.

ROTATING THE SAW BAR

Maximum saw bar life can be achieved by occasionally turning the bar over so the top and bottom bar surfaces wear evenly. Refer to the saw bar disassembly procedures in the Service Manual for further details.

TROUBLESHOOTING

| Problem | Cause | Solution |
|---|---|--|
| Excessive vibration and cuts rough. | Loose chain tension. | Retension the chain. |
| | Excessive feed force. | Reduce feed force. |
| Chain saw will not cut straight. | Operator feed force not applied directly over centerline of saw. Accumulated saw bar wear and uneven chain segment profile wear. | Move left hand closer to centerline of saw bar. Turn the saw bar over and dress rails square. Replace the saw bar and chain. |
| Loss of power. | Drive sprocket slipping on Trantorque® adapter. | Adjust and tighten Trantorque® adapter, (30 ft. lbs/40.6 Nm). |
| Chain saw does not run. | Power source not functioning. | Check power source for proper flow and pressure (7–9 gpm/26–34 lpm @2000 psi/140 bar). |
| | Coupler or hoses are blocked. | Remove obstruction. |
| | Mechanical failure. | Disassemble the chain saw and inspect for damage. |
| Chain saw runs backwards. | Pressure and return hoses reversed. | Connect for proper flow direction. Motor shaft must rotate clockwise. |
| Trigger is hard to press. | Pressure and return hoses reversed. | Connect to proper flow direction. Motor shaft must rotate clockwise. |
| | Back pressure too high. | Should not exceed 250 psi/17 bar @ 9 gpm/34 lpm measured at the end of the chain saw's operating hoses. |
| Fluid leakage around drive sprocket. | Motor shaft seal failure. | Replace as required. |
| Fluid leakage between the rear gear housing and the chain saw adaptor. | Motor face seal failure. | Replace as required. |
| Fluid leakage between the valve handle and the extension housing. | Oil tube seal failure. | Replace as required. |
| Fluid leakage between the extension housing assembly and the chain saw adaptor. | Oil tube seal failure. | Replace as required. |
| Chain saw cuts slow. | Insufficient hydraulic fluid flow or low relief valve setting. | Adjust proper hydraulic fluid flow to proper gpm. For optimum performance, adjust relief valve to 2100–2250 psi/145–155 bar. |

TROUBLESHOOTING

| Problem | Cause | Solution |
|-------------------------------------|--|---|
| Chain saw cuts slow. | Back pressure too high. | Should not exceed 250 psi/17 bar @ 9 gpm/34 lpm measured at the end of the chain saw's operating hoses. |
| | Loss of diamond segment side clearance. | Replace the chain. |
| | Hydraulic fluid mixed in water supply. | Check motor for leaks. |
| | Wrong chain for application. | Scale down to a lower numbered chain. |
| | Wire edged bar rails. | Dress rails square. |
| Excessive vibration and cuts rough. | Segment(s) broken or missing from chain. | Remove and repair broken segment or replace chain. |

NOTICE

In addition to the Safety Precautions found in this manual, observe the following for equipment protection and care.

- Make sure all couplers are wiped clean before connection.
- The hydraulic circuit control valve must be in the **OFF** position when coupling or uncoupling hydraulic tools. Failure to do so may result in damage to the quick couplers and cause overheating of the hydraulic system.
- Always store the tool in a clean dry space, safe from damage or pilferage.
- Make sure the circuit **PRESSURE** hose (with male quick disconnect) is connected to the **IN** port. The circuit **RETURN** hose (with female quick disconnect) is connected to the opposite port. Do not reverse circuit flow. This can cause damage to internal seals.
- Always replace hoses, couplings and other parts with replacement parts recommended by Stanley Hydraulic Tools. Supply hoses must have a minimum working pressure rating of 2500 psi/172 bar.
- Do not exceed the rated flow (see Specifications) page in this manual for correct flow rate and model number. Rapid failure of the internal seals may result.
- Always keep critical tool markings, such as warning stickers and tags legible.
- Tool repair should be performed by experienced personnel only.
- Make certain that the recommended relief valves are installed in the pressure side of the system.
- Do not use the tool for applications for which it was not intended.
- Oil the chain at the end of the day to prevent rust but be careful not to over tension in this condition.

SPECIFICATIONS

| | |
|--------------------------|--|
| Input Flow Range | 7–9 gpm/26–34 lpm |
| Input Pressure | 2000 psi/140 bar |
| Chain Type | Force 4 (.444) inch Pitch |
| Weight (with bar) | 26 lbs/11.8 kg |
| Length..... | 35 or 38 inches/89 or 97 cm |
| Width | 9 inches/23 cm |
| Lubrication/Cooling..... | Internal water channels in bar |
| Porting | -8 SAE O-ring |
| Connection | 3/8 inch Flush-Face Quick Disconnect Coupler |
| Hose Whips | Yes |
| Sound Power Level | 109 dBA |
| Vibration Level..... | Main Handle 4.9 m/s ² Assist Handle 5.2 m/s ² |

| SOUND AND VIBRATION DECLARATION | |
|--|-------------------------|
| Test conducted on DS12318, operated at 8 gpm input | |
| Measured A-weighted sound power level, L _{wa} (ref. 1pW) in decibels | 109 dBA |
| Uncertainty, K _{wa} , in decibels | 3 dBA |
| Measured A-weighted sound pressure level, L _{pa} (ref. 20 µPa) at operator's position, in decibels | 101 dBA |
| Uncertainty, K _{pa} , in decibels | 3 dBA |
| Values determined according to noise test code given in ISO 15744, using the basic standard ISO 3744 | |
| NOTE: The sum of a measured noise emission value and its associated uncertainty represents an upper boundary of the range of values which is likely to occur in measurements. | |
| Declared vibration emission value in accordance with EN 12096 | |
| Measured vibration emission value (Main Handle): a | 4.9 m/sec ² |
| Uncertainty: K | 1.5 m/sec ² |
| Measured vibration emission value (Assist Handle): a | 5.2 m/sec ² |
| Uncertainty: K | 1.25 m/sec ² |
| Values determined according to ISO 7505, ISO 8662-1, ISO 5349-1,2 | |

ACCESSORIES

| | |
|--|----------|
| Water Pump, 12 VDC, DC Plug, Marine Type | DCP30100 |
| Water Pump, 12 VDC, Battery Clips..... | DCP30101 |
| 3/8 inch Flush-Face Coupler Set..... | 03971 |
| 25 feet, 1/2 inch Dual Hose with Flush-Face Couplers | 31972 |
| 50 feet, 1/2 inch Dual Hose with Flush-Face Couplers | 31848 |
| Chain 15-inch | 71050 |
| Bar 15-inch | 71049 |
| Chain 18-inch | 71048 |
| Bar 18-inch | 71047 |
| Pipe Clamp Assembly..... | 71055 |
| Drive Sprocket..... | 71046 |
| Water Flow Meter, 0–7 GPM | 60859 |

DS12 PARTS ILLUSTRATION

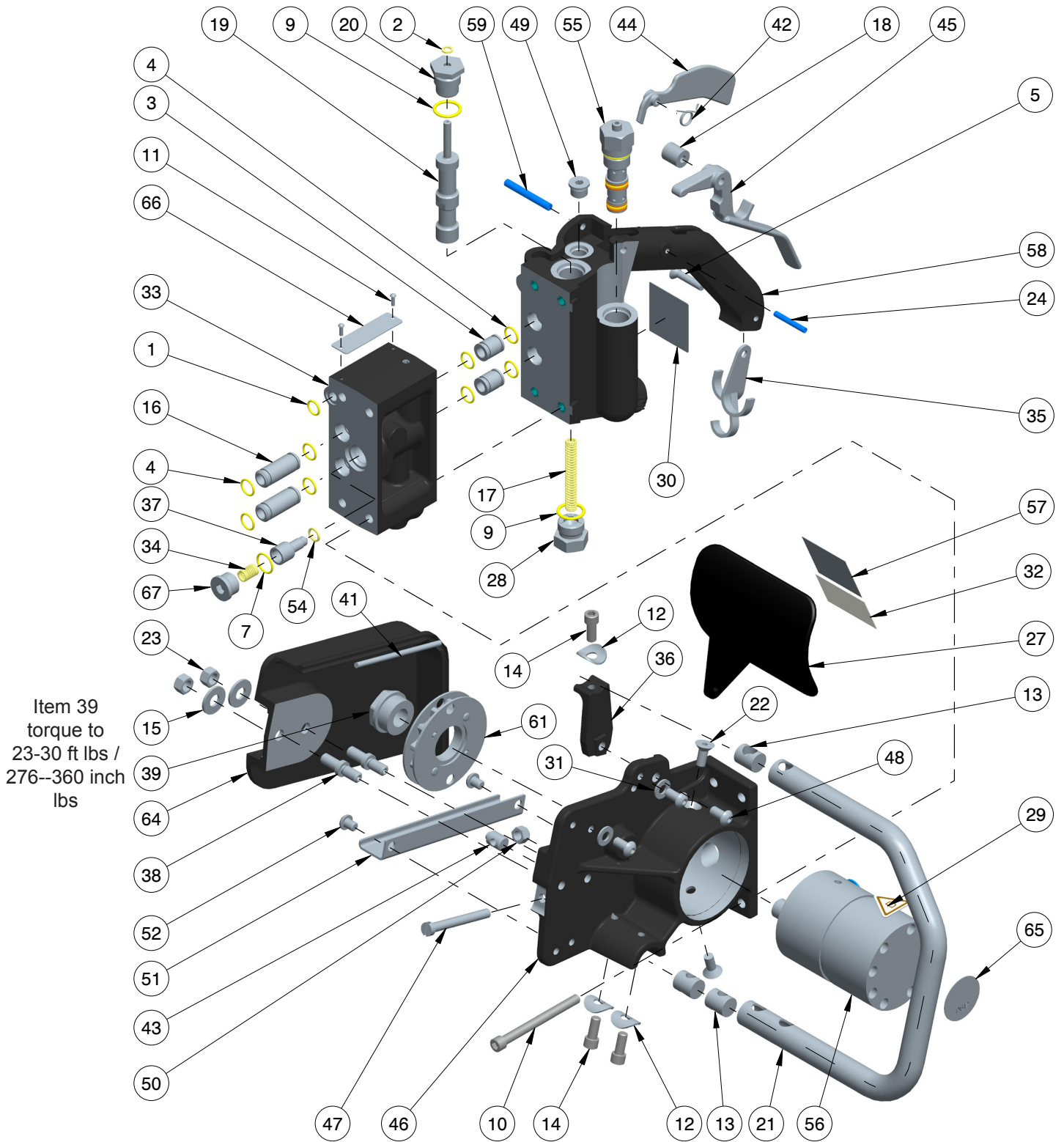

DS12 PARTS LIST

| ITEM | PART NO.. | QTY | DESCRIPTION |
|------|-----------|-----|----------------------------------|
| 1 | 00018 | 1 | O-RING 7/16 X 9/16 X 1/16 -013* |
| 2 | 00112 | 1 | QUAD RING 1/4 X 3/8 X 1/16 -010* |
| 3 | 00174 | 2 | OIL TUBE |
| 4 | 00175 | 8 | O-RING 1/2 X 5/8 X 1/16 -014* |
| 5 | 00787 | 1 | CAPSCREW 1/4-20 X 1-1/4 HSFT SST |
| 7 | 01211 | 1 | O-RING 5/8 X 3/4 X 1/16 -016* |
| 8 | 01420 | 1 | HELICOIL 5/16-18 UNC X .312 LG. |
| 9 | 01604 | 2 | O-RING .755 X .949 X .097 -910* |
| 10 | 01758 | 4 | HSHCS 5/16-18 X 3-1/2 |
| 11 | 02004 | 2 | #4 X 3/8 DRIVE SCREW |
| 12 | 02643 | 3 | WASHER |
| 13 | 02649 | 3 | HANDLE BAR RETAINER |
| 14 | 02764 | 3 | HSHCS 5/16-18 X 3/4 |
| 15 | 02766 | 2 | WASHER .438" I.D. |
| 16 | 02912 | 2 | OIL TUBE |
| 17 | 02916 | 1 | COMPRESSION COIL SPRING |
| 18 | 02920 | 1 | ON-OFF VALVE SPACER |
| 19 | 02925 | 1 | VALVE SPOOL |
| 20 | 02931 | 1 | ON-OFF VALVE CAP |
| 21 | 02936 | 1 | HANDLE BAR |
| 22 | 03006 | 2 | CAPSCREW 5/16-18 X 3/4 HSFT |
| 23 | 03276 | 2 | HEX NUT 3/8-16UNC |
| 24 | 03278 | 1 | ROLL PIN 3/16 O.D. X 1.375 LG. |
| 27 | 07473 | 1 | HAND GUARD |
| 28 | 09437 | 1 | PLUG |
| 29 | 11207 | 1 | CIRCUIT TYPE "D" STICKER |
| 30 | 11212 | 1 | SOUND POWER LEVEL STICKER - 109 |
| 31 | 12175 | 2 | WASHER 5/16" I.D. |
| 32 | 12412 | 1 | DANGER STICKER - ELECTRICAL |
| 33 | 20453 | 1 | EXTENSION HOUSING |
| 34 | 20458 | 1 | COMPRESSION COIL SPRING |
| 35 | 20459 | 1 | HOSE CLIP |
| 36 | 20461 | 1 | HANDLE STRUT ASSY |
| 37 | 20463 | 1 | WATER VALVE |
| 38 | 20465 | 2 | STUD |
| 39 | 20471 | 1 | TRANTORQUE ADAPTER |
| 41 | 20721 | 1 | BULK 3/16 CORD STOCK |
| 42 | 22701 | 1 | TORSION SPRING |
| 43 | 22702 | 1 | BAR ADJUSTMENT NUT |

| ITEM | PART NO.. | QTY | DESCRIPTION |
|------|-----------|-----|--------------------------------------|
| 44 | 22704 | 1 | SAFETY CATCH |
| 45 | 22707 | 1 | TRIGGER |
| 46 | 22713 | 1 | CHAIN SAW ADAPTOR |
| 47 | 22714 | 1 | 5/16-18x2.750 FILL. HEAD, SS |
| 48 | 22715 | 3 | HSBH Capscrew, 5/16-18 x 5/8 |
| 49 | 08104 | 1 | PLUG 3/8 SAE |
| 50 | 22752 | 1 | NYLOCK NUT 5/16-18UNC |
| 51 | 22945 | 1 | CHAIN COVER |
| 52 | 23196 | 2 | CAPSCREW 5/16UNCx3/8 HSBH |
| 54 | 25260 | 1 | QUAD RING 3/8 X 1/2 X 1/16 -012* |
| 55 | 25635 | 1 | FLOW REGLTR.CRTRDG. |
| 56 | 25688 | 1 | MOTOR ASSY (SEE PAGE 21 FOR PARTS) |
| 57 | 28409 | 1 | COMPOSITE STICKER |
| 58 | 28552 | 1 | VALVE HANDLE ASSY (INCLUDES ITEM 49) |
| 59 | 31804 | 1 | ROLL PIN 1/4 O.D. X 2.000 LG. |
| 61 | 71046 | 1 | DUCTILE IRON CHAIN SPROCKET |
| 64 | 71051 | 1 | CHAIN GUARD, DUCTILE IRON |
| 65 | 71071 | 1 | NAME TAG - DS12 |
| 66 | 71073 | 1 | TOOL PLATE |
| 67 | 350237 | 1 | HOLLOW HEX PLUG - 8 SAE |

* Part of Seal Kit

| SEAL KIT P/N 22798 | | |
|--------------------|-------------|---|
| 00018 | O-RING | 1 |
| 00112 | QUAD RING | 1 |
| 00173 | QUAD RING | 1 |
| 00175 | O-RING | 8 |
| 00178 | O-RING | 1 |
| 00669 | QUAD RING | 1 |
| 01211 | O-RING | 2 |
| 01604 | O-RING | 2 |
| 01605 | O-RING | 3 |
| 02905 | O-RING | 1 |
| 03110 | TEFLON SEAL | 1 |
| 03847 | HOSE WASHER | 1 |
| 25260 | QUAD RING | 1 |
| 350771 | O-RING | 1 |

DS12 MOTOR PARTS LIST

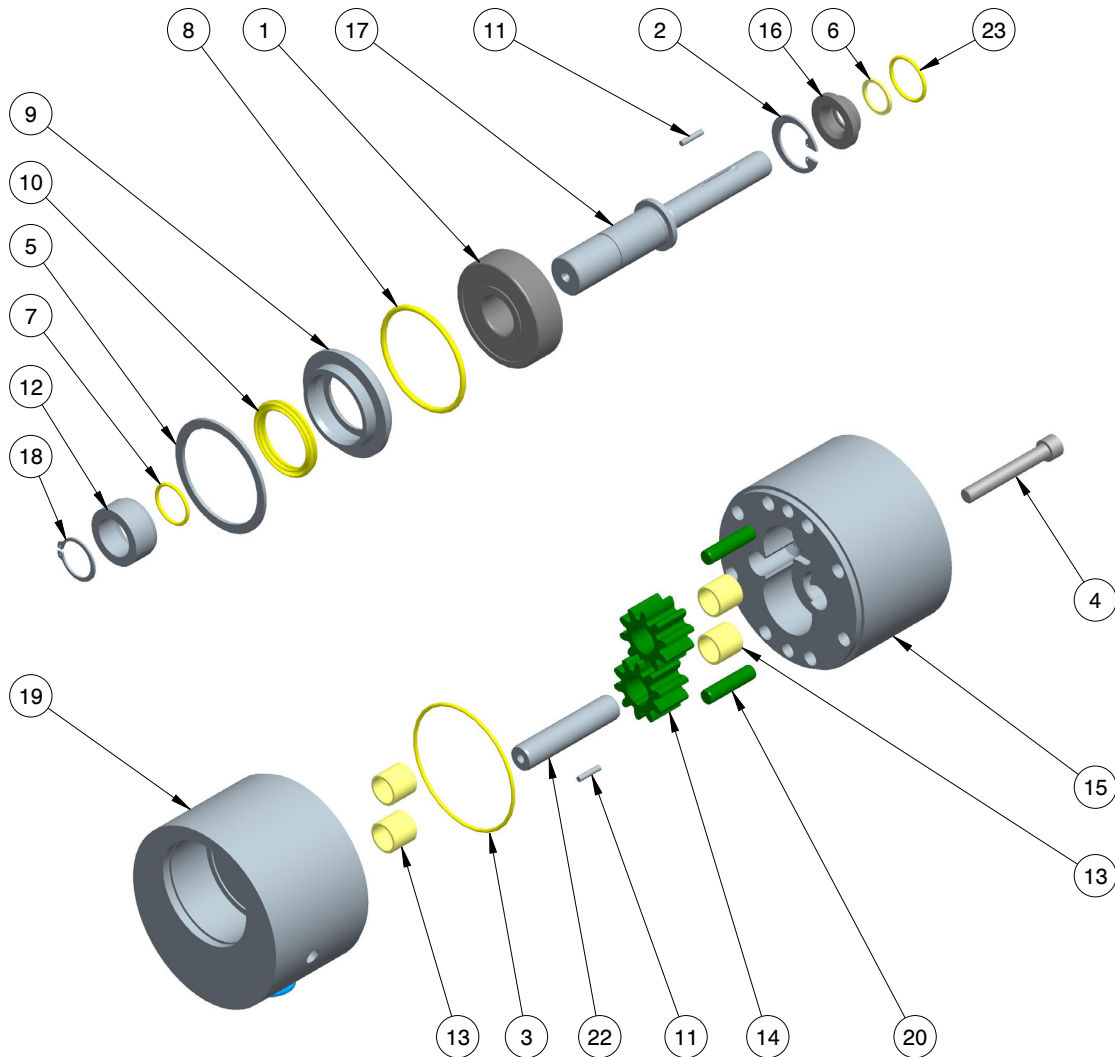

| ITEM | PART NO.. | QTY | DESCRIPTION |
|------|-----------|-----|----------------------------|
| 1 | 00148 | 1 | BEARING |
| 2 | 00170 | 1 | RETAINING RING |
| 3 | 00178 | 1 | O-RING* |
| 4 | 00208 | 8 | HSHCS 1/4-20 X 1-3/4 |
| 5 | 00633 | 1 | RET RING SPIROLOX INTERNAL |
| 6 | 00669 | 1 | QUAD RING* |
| 7 | 01211 | 1 | O-RING* |
| 8 | 02905 | 1 | O-RING* |
| 9 | 03104 | 1 | KEEPER-SEAL & BEARING |
| 10 | 03110 | 1 | ROTARY SHAFT SEAL * |
| 11 | 03227 | 2 | DOWEL PIN |

| ITEM | PART NO.. | QTY | DESCRIPTION |
|------|-----------|-----|---|
| 12 | 03280 | 1 | SPACER, SEAL RACE |
| 13 | 06316 | 2 | BUSHING, GARLOCK |
| 14 | 06838 | 2 | DRIVE GEAR |
| 15 | 06861 | 1 | GEAR HOUSING ASSY (INCLUDES ITEMS 13 & 20) |
| 16 | 19884 | 1 | SEAL GLAND |
| 17 | 20466 | 1 | MOTOR SHAFT |
| 18 | 20472 | 1 | RETAINING RING EXTERNAL |
| 19 | 21436 | 1 | FRONT BEARING HOUSING ASSY (INCLUDES ITEM 13) |
| 20 | 25444 | 2 | DOWEL PIN 1/4 X 1 |
| 22 | 73308 | 1 | IDLER SHAFT KEYED |
| 23 | 350771 | 1 | O-RING* |

* Part of Seal Kit 22798

DS12 PARTS LIST

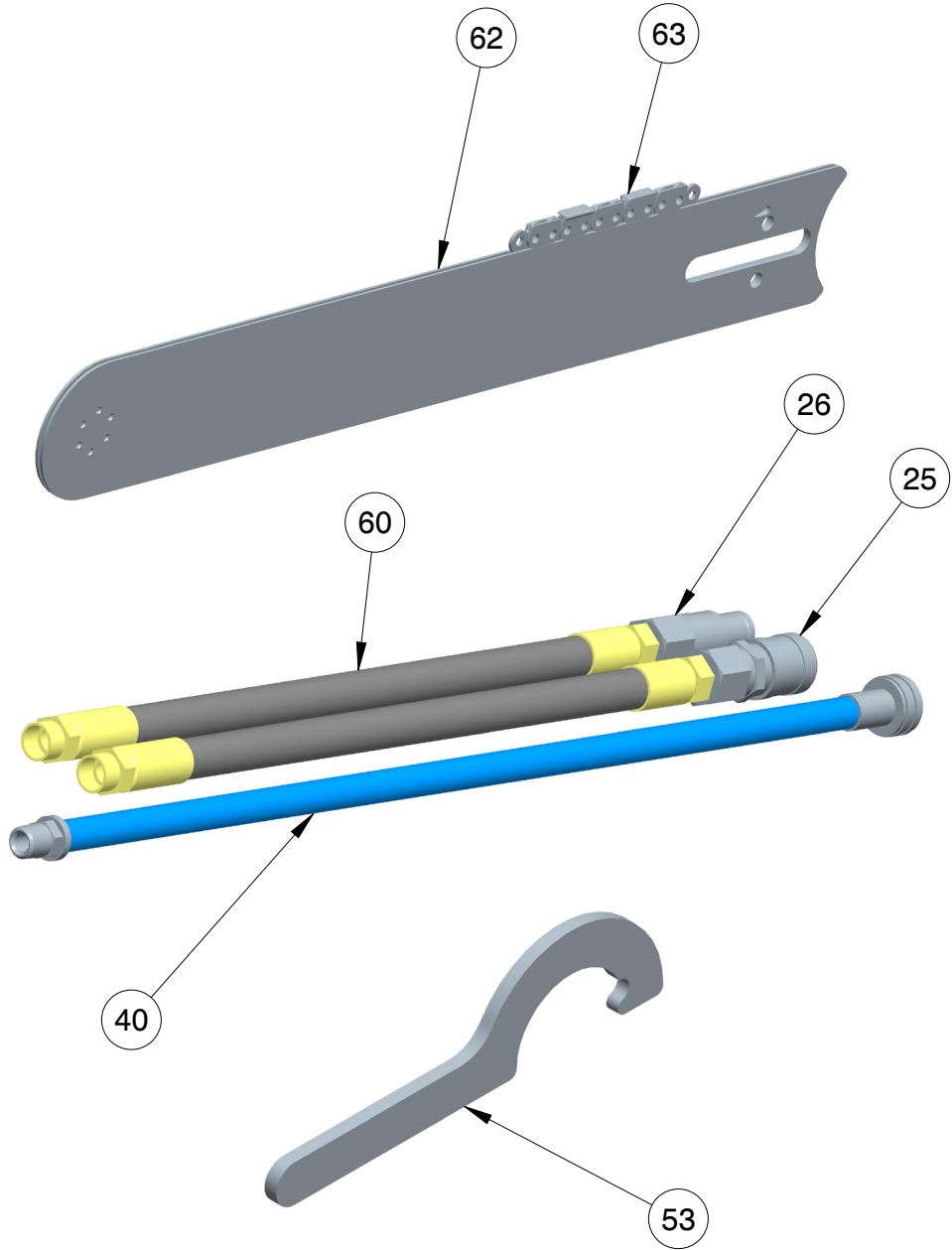

| ITEM | P/N | QTY | DESCRIPTION |
|------|-------|-----|--|
| 25 | 03972 | 1 | COUPLER 3/8 FEM 3/8 NPT (COUPLER SET P/N-03971) |
| 26 | 03973 | 1 | COUPLER 3/8 MALE 3/8 NPT (COUPLER SET P/N-03971) |
| 40 | 20497 | 1 | WATER HOSE ASSY |
| 53 | 23517 | 1 | SPROCKET WRENCH |
| 60 | 56725 | 1 | HOSE ASSY 18 INCH |
| 62 | 71047 | 1 | DUCTILE IRON CHAIN BAR 18 IN. |
| 63 | 71048 | 1 | DUCTILE IRON CHAIN 18 IN. |

SAW CLAMP INSTRUCTIONS

⚠ WARNING

A potentially hazardous situation exists which, if not avoided, could result in death or serious injury

Before cutting, make sure the pipe is in a safe condition to be cut. Support the work piece in such a way that the cut remains open during the cutting operation and when the cut is finished. Pinching the chain during the cut could cause chain breakage and could result in death or serious injury to the operator.

If using the pipe clamp accessory, the clamp must be attached in such a way that it does not move during the cutting operation and/or when the cut is finished. Unexpected movement of the clamp could cause loss of control of the saw and could result in death or serious injury to the operator.

CLAMP AND SAW INSTALLATION

STEP 1

Attach the axle to the saw:

Remove the two nuts and washers that secure the chain guard to the saw and install the axle over the chain guard, then re-install the two nuts and washers.

NOTE:

This is a good time to check the chain tension on your saw (see the *DS12 Service Manual* for proper chain tension).

STEP 2

Place the clamp around top of the pipe. Hand tighten the adjustment nut.

STEP 3

Position the saw with the attached axle on the pipe clamp by sliding the saw clamp axle through the receiver hole at top of the clamp. Secure with a snap pin.

STEP 4

Ensure that the saw is positioned to allow the handle to pivot during the cut unobstructed and to ensure that the saw tip doesn't contact dirt. If necessary, reposition the saw clamp/saw assembly around the pipe to optimum cutting position.

STEP 5

Tighten the clamp nut with a wrench to ensure that clamp does not move during cutting operation.

CUTTING TIPS

Position the saw to avoid pinching the blade or the chain

as the pipe is cut. Support both ends of the pipe to prevent movement and possible injury to the operator.

- Hold the saw so that the chain isn't in contact with the pipe. Start the water and activate the saw to full power. Press the chain against the pipe slowly, applying pressure to cut through the pipe.
- Pressure can be applied to the cut until the saw motor starts to lug.

AFTER CUTTING

When finished cutting, be sure to remove the saw first, and then the clamp.



STANLEY®

Stanley Hydraulic Tools
3810 SE Naef Road
Milwaukie, Oregon 97267-5698 USA
(503) 659-5660 / Fax (503) 652-1780
www.stanleyhydraulics.com