

# STANLEY®

## FG10 HYDRAULIC FROG GRINDER PG05 HYDRAULIC PROFILE GRINDER



### USER MANUAL Safety, Operation and Maintenance



© 2014 Stanley Black & Decker, Inc.  
New Britain, CT 06053  
U.S.A.  
28072 2/2014 Ver. 8

# DECLARATION OF CONFORMITY

DECLARATION OF CONFORMITY  
 ÜBEREINSTIMMUNGS-ERKLÄRUNG  
 DECLARATION DE CONFORMITE CEE  
 DECLARACION DE CONFORMIDAD  
 DICHIARAZIONE DI CONFORMITA

**STANLEY.**  
 Hydraulic Tools



I, the undersigned:  
 Ich, der Unterzeichnende:  
 Je soussigné:  
 El abajo firmante:  
 lo sottoscritto:

**Weisbeck, Andy**

Surname and First names/Familiennamen und Vornamen/Nom et prénom/Nombre y apellido/Cognome e nome

hereby declare that the equipment specified hereunder:  
 bestätige hiermit, daß erklaren Produkt genannten Werk oder Gerät:  
 déclare que l'équipement visé ci-dessous:  
 Por la presente declaro que el equipo se especifica a continuación:  
 Dichiaro che le apparecchiature specificate di seguito:

- Category: **Grinder, Hydraulic**  
 Kategorie:  
 Catégorie:  
 Categoria:  
 Categoría:
- Make/Marke/Marque/Marca/Marca **Stanley**
- Type/Typ/Type/Tipo/Tipo: **FG1011001**
- Serial number of equipment:  
 Seriennummer des Geräts:  
 Numéro de série de l'équipement:  
 Numero de serie del equipo:  
 Matricola dell'attrezzatura: **All**

Has been manufactured in conformity with  
 Wurde hergestellt in Übereinstimmung mit  
 Est fabriqué conformément  
 Ha sido fabricado de acuerdo con  
 E' stata costruita in conformità con

Directive/Standards Richtlinie/Standards Directives/Normes Directriz/Los Normas Direttiva/Norme	No. Nr Numéro No n.	Approved body Prüfung durch Organisme agréé Aprobado Collaudato
EN ISO ISO ISO Machinery Directive	3744:2010 11148-7:2012 28927-1:2009 2006/42/EC:2006	Self Self Self Self

- Special Provisions: **None**  
 Spezielle Bestimmungen:  
 Dispositions particulières:  
 Provisiones especiales:  
 Disposizioni speciali:
- Representative in the Union: **Patrick Vervier, Stanley Dubuis 17-19, rue Jules Berthonneau-BP 3406 41034 Blois Cedex, France.**  
 Vertreter in der Union/Représentant dans l'union/Representante en la Union/Rappresentante presso l'Unione

Done at/Ort/Fait à/Dado en/Fatto a Stanley Hydraulic Tools, Milwaukie, Oregon USA Date/Datum/le/Fecha/Data 1-10-11

Signature/Unterschrift/Signature/Firma/Firma

Position/Position/Fonction/Cargo/Posizione Director of Product Development

# TABLE OF CONTENTS

DECLARATION OF CONFORMITY .....	2
SAFETY SYMBOLS .....	4
SAFETY PRECAUTIONS.....	5
TOOL STICKERS & TAGS .....	6
HOSE TYPES.....	7
HOSE RECOMMENDATIONS .....	8
HTMA REQUIREMENTS.....	9
OPERATION.....	10
TOOL PROTECTION & CARE .....	13
TROUBLESHOOTING .....	14
ACCESSORIES.....	15
SPECIFICATIONS .....	15
FG10 & PG05 PARTS ILLUSTRATION.....	16
FG10 & PG05 PARTS ILLUSTRATION.....	17
FG10 PARTS LIST .....	18
PG05 PARTS LIST .....	20
SPARK GUARD & INNER GUARD .....	22

## IMPORTANT

To fill out a Product Warranty Validation form, and for information on your warranty, visit [Stanleyhydraulics.com](http://Stanleyhydraulics.com) and select the Company tab, Warranty.  
(NOTE: The warranty Validation record must be submitted to validate the warranty).

**SERVICING:** This manual contains safety, operation, and routine maintenance instructions. Stanley Hydraulic Tools recommends that servicing of hydraulic tools, other than routine maintenance, must be performed by an authorized and certified dealer. Please read the following warning.

## ⚠ WARNING

**SERIOUS INJURY OR DEATH COULD RESULT FROM THE IMPROPER REPAIR OR SERVICE OF THIS TOOL.**

**REPAIRS AND / OR SERVICE TO THIS TOOL MUST ONLY BE DONE BY AN AUTHORIZED AND CERTIFIED DEALER.**

For the nearest authorized and certified dealer, call Stanley Hydraulic Tools at the number listed on the back of this manual and ask for a Customer Service Representative.



# SAFETY PRECAUTIONS

Tool operators and maintenance personnel must always comply with the safety precautions given in this manual and on the stickers and tags attached to the tool and hose.

These safety precautions are given for your safety. Review them carefully before operating the tool and before performing general maintenance or repairs.

Supervising personnel should develop additional precautions relating to the specific work area and local safety regulations. If so, place the added precautions in the space provided in this manual.

The model FG10 Hydraulic Frog Grinder or the model PG05 Profile Grinder will provide safe and dependable service if operated in accordance with the instructions given in this manual. Read and understand this manual and any stickers and tags attached to the grinder and hose before operation. Failure to do so could result in personal injury or equipment damage.



- The operator must start in a work area without bystanders. Flying debris can cause serious injury.
- Do not operate the tool unless thoroughly trained or under the supervision of an instructor. Establish a training program for all operators to ensure safe operation.
- Always wear safety equipment such as goggles, ear and head protection, and safety shoes at all times when operating the tool. Use gloves and aprons when necessary.
- The operator must be familiar with all prohibited work areas such as excessive slopes and dangerous terrain conditions.
- Maintain proper footing and balance at all times.
- Do not inspect, clean or replace the grinding wheel while the hydraulic power source is connected. Do not inspect or clean the tool while the hydraulic power source is connected. Accidental engagement of the tool can cause serious injury.
- Always connect hoses to the tool hose couplers before energizing the hydraulic power source. Be sure all hose connections are tight and are in good condition.
- Do not operate the tool at oil temperatures above 140°F/60°C. Operation at higher temperatures can cause higher than normal temperatures at the tool which can result in operator discomfort.
- Do not operate the tool with the wheel guard removed.
- Do not operate a damaged, improperly adjusted, or incompletely assembled grinder.
- Never wear loose clothing that can get entangled in the working parts of the tool.
- Keep all parts of your body away from the rotating wheel. Long hair or loose clothing can become drawn into rotating components.
- Keep the wheel off all surfaces when starting the grinder.
- Do not use a wheel that is cracked, chipped or otherwise damaged. Always inspect wheels for possible damage before installation or use.
- Always use wheels that conform to the specifications given in the OPERATION section of this manual.
- Do not reverse grinding wheel rotation direction by changing fluid flow direction.
- Do not move the tool until the wheel has stopped rotating. Release the trigger if the power supply has been interrupted.

# TOOL STICKERS & TAGS

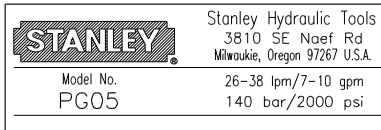

29715  
PG05 Name Tag

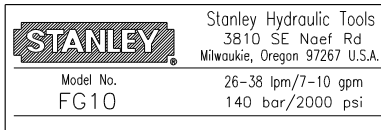

28727  
FG10 Name Tag



25610  
Railroad Help Desk Decal

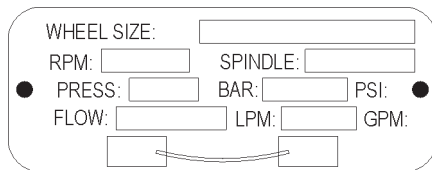

28811  
Information Plaque (CE)

**NOTE:**  
THE INFORMATION LISTED ON THE STICKERS SHOWN, MUST BE LEGIBLE AT ALL TIMES.  
REPLACE DECALS IF THEY BECOME WORN OR DAMAGED. REPLACEMENTS ARE AVAILABLE FROM YOUR LOCAL STANLEY DISTRIBUTOR.

The safety tag (P/N 15875) at right is attached to the tool when shipped from the factory. Read and understand the safety instructions listed on this tag before removal. We suggest you retain this tag and attach it to the tool when not in use.

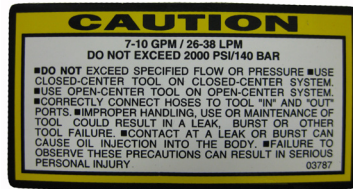

03787  
GPM Decal

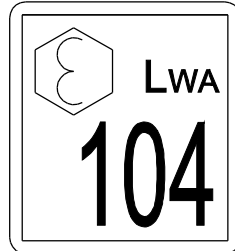

20647  
Sound Power Level Decal (CE)



28409  
Composite Decal (CE)



28322  
CE Decal



11207  
Circuit Type D Decal (CE)



25790  
Caution Decal



05152  
Stanley Sticker



28376  
Stanley Logo Decal (CE)

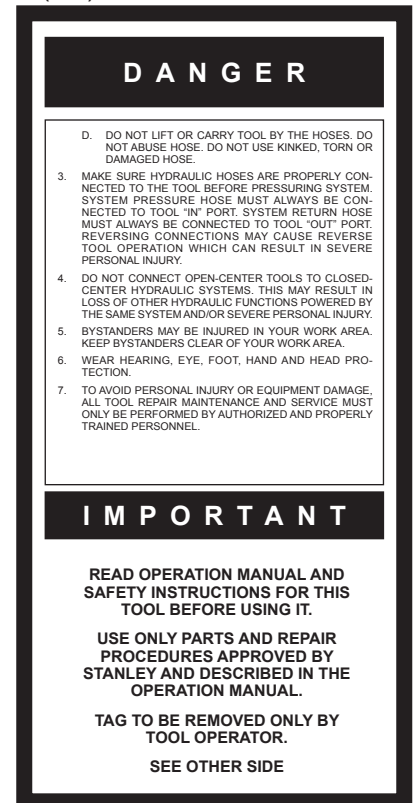
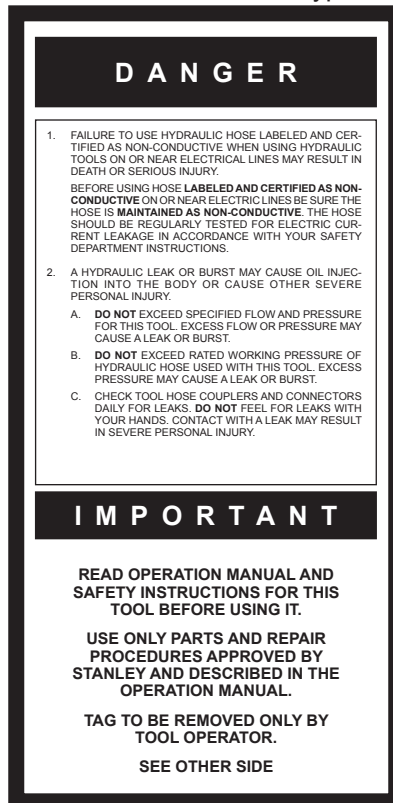

SAFETY TAG P/N 15875 (Shown smaller than actual size)

# HOSE TYPES

The rated working pressure of the hydraulic hose must be equal to or higher than the relief valve setting on the hydraulic system. There are three types of hydraulic hose that meet this requirement and are authorized for use with Stanley Hydraulic Tools. They are:

**Certified non-conductive** — constructed of thermoplastic or synthetic rubber inner tube, synthetic fiber braid reinforcement, and weather resistant thermoplastic or synthetic rubber cover. *Hose labeled **certified non-conductive** is the only hose authorized for use near electrical conductors.*

**Wire-braided** (conductive) — constructed of synthetic rubber inner tube, single or double wire braid reinforcement, and weather resistant synthetic rubber cover. *This hose is **conductive** and must never be used near electrical conductors.*

**Fabric-braided** (not certified or labeled non-conductive) — constructed of thermoplastic or synthetic rubber inner tube, synthetic fiber braid reinforcement, and weather resistant thermoplastic or synthetic rubber cover. *This hose is **not certified non-conductive** and must never be used near electrical conductors.*

## HOSE SAFETY TAGS

To help ensure your safety, the following DANGER tags are attached to all hose purchased from Stanley Hydraulic Tools. **DO NOT REMOVE THESE TAGS.**

If the information on a tag is illegible because of wear or damage, replace the tag immediately. A new tag may be obtained from your Stanley Distributor.

### THE TAG SHOWN BELOW IS ATTACHED TO “CERTIFIED NON-CONDUCTIVE” HOSE

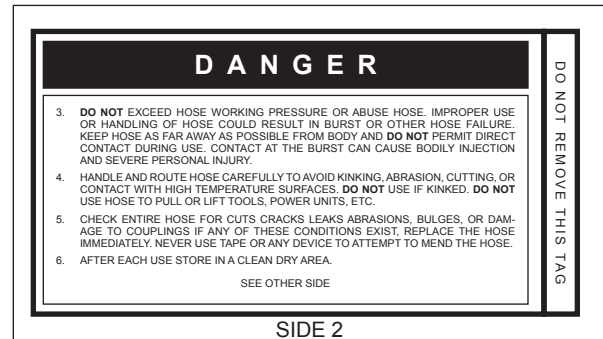
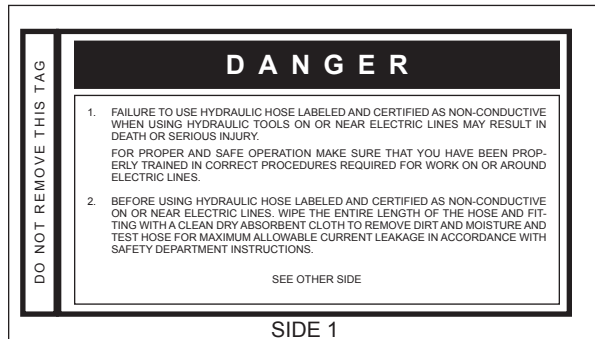

(Shown smaller than actual size)

### THE TAG SHOWN BELOW IS ATTACHED TO “CONDUCTIVE” HOSE.

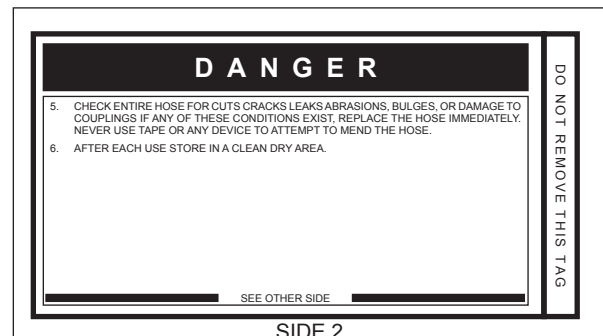
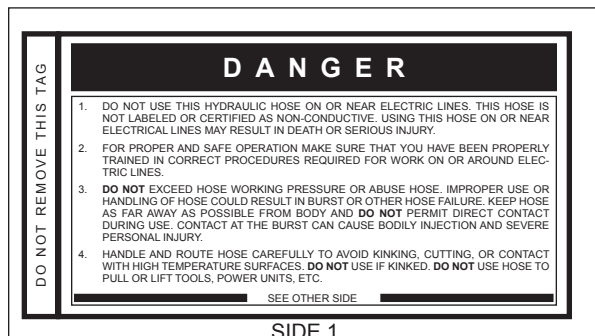

(Shown smaller than actual size)



# HOSE RECOMMENDATIONS

## Tool to Hydraulic Circuit Hose Recommendations

The chart to the right shows recommended minimum hose diameters for various hose lengths based on gallons per minute (gpm)/liters per minute (lpm). These recommendations are intended to keep return line pressure (back pressure) to a minimum acceptable level to ensure maximum tool performance.

This chart is intended to be used for hydraulic tool applications only based on Stanley Hydraulic Tools tool operating requirements and should not be used for any other applications.

All hydraulic hose must have at least a rated minimum working pressure equal to the maximum hydraulic system relief valve setting.

**All hydraulic hose must meet or exceed specifications as set forth by SAE J517.**

Oil Flow		Hose Lengths		Inside Diameter		USE (Press/Return)	Min. Working Pressure	
GPM	LPM	FEET	METERS	INCH	MM		PSI	BAR
<b>Certified Non-Conductive Hose - Fiber Braid - for Utility Bucket Trucks</b>								
4-9	15-34	up to 10	up to 3	3/8	10	Both	2250	155
<b>Conductive Hose - Wire Braid or Fiber Braid - DO NOT USE NEAR ELECTRICAL CONDUCTORS</b>								
4-6	15-23	up to 25	up to 7.5	3/8	10	Both	2500	175
4-6	15-23	26-100	7.5-30	1/2	13	Both	2500	175
5-10.5	19-40	up to 50	up to 15	1/2	13	Both	2500	175
5-10.5	19-40	51-100	15-30	5/8	16	Both	2500	175
5-10.5	19-40	100-300	30-90	5/8	16	Pressure	2500	175
10-13	38-49	up to 50	up to 15	3/4	19	Return	2500	175
10-13	38-49	51-100	15-30	5/8	16	Both	2500	175
10-13	38-49	100-200	30-60	3/4	19	Pressure	2500	175
13-16	49-60	up to 25	up to 8	5/8	16	Return	2500	175
13-16	49-60	26-100	8-30	3/4	19	Pressure	2500	175
				1	25.4	Return	2500	175
				5/8	16	Pressure	2500	175
				3/4	19	Return	2500	175
				3/4	19	Pressure	2500	175
				1	25.4	Return	2500	175

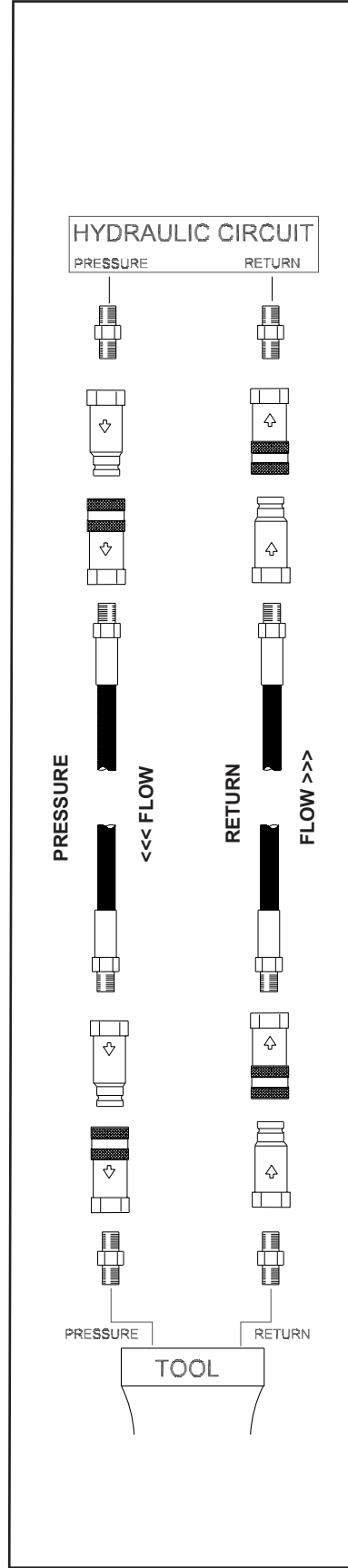

Figure 1. Typical Hose Connections



# HTMA / EHTMA REQUIREMENTS

## HTMA / EHTMA REQUIREMENTS

### HTMA





#### HYDRAULIC SYSTEM REQUIREMENTS

#### TOOL TYPE

	TYPE I	TYPE II	TYPE RR	TYPE III
Flow Range	4-6 gpm (15-23 lpm)	7-9 gpm (26-34 lpm)	9-10.5 gpm (34-40 lpm)	11-13 gpm (42-49 lpm)
Nominal Operating Pressure (at the power supply outlet)	1500 psi (103 bar)	1500 psi (103 bar)	1500 psi (103 bar)	1500 psi (103 bar)
System relief valve setting (at the power supply outlet)	2100-2250 psi (145-155 bar)	2100-2250 psi (145-155 bar)	2200-2300 psi (152-159 bar)	2100-2250 psi (145-155 bar)
Maximum back pressure (at tool end of the return hose)	250 psi (17 bar)	250 psi (17 bar)	250 psi (17 bar)	250 psi (17 bar)
Measured at a max. fluid viscosity of: (at min. operating temperature)	400 ssu* (82 centistokes)	400 ssu* (82 centistokes)	400 ssu* (82 centistokes)	400 ssu* (82 centistokes)
Temperature: Sufficient heat rejection capacity to limit max. fluid temperature to: (at max. expected ambient temperature)	140° F (60° C)	140° F (60° C)	140° F (60° C)	140° F (60° C)
Min. cooling capacity at a temperature difference of between ambient and fluid temps	3 hp (2.24 kW) 40° F (22° C)	5 hp (3.73 kW) 40° F (22° C)	6 hp (5.22 kW) 40° F (22° C)	7 hp (4.47 kW) 40° F (22° C)
<b>NOTE:</b> Do not operate the tool at oil temperatures above 140° F (60° C). Operation at higher temperatures can cause operator discomfort at the tool.				
Filter Min. full-flow filtration Sized for flow of at least: (For cold temp. startup and max. dirt-holding capacity)	25 microns 30 gpm (114 lpm)	25 microns 30 gpm (114 lpm)	25 microns 30 gpm (114 lpm)	25 microns 30 gpm (114 lpm)
Hydraulic fluid Petroleum based (premium grade, anti-wear, non-conductive) Viscosity (at min. and max. operating temps)	100-400 ssu*	100-400 ssu* (20-82 centistokes)	100-400 ssu*	100-400 ssu*
<b>NOTE:</b> When choosing hydraulic fluid, the expected oil temperature extremes that will be experienced in service determine the most suitable temperature viscosity characteristics. Hydraulic fluids with a viscosity index over 140 will meet the requirements over a wide range of operating temperatures.				
*SSU = Saybolt Seconds Universal				

### EHTMA HYDRAULIC SYSTEM REQUIREMENTS

### CLASSIFICATION

					
Flow Range	3.5-4.3 gpm (13.5-16.5 lpm)	4.7-5.8 gpm (18-22 lpm)	7.1-8.7 gpm (27-33 lpm)	9.5-11.6 gpm (36-44 lpm)	11.8-14.5 gpm (45-55 lpm)
Nominal Operating Pressure (at the power supply outlet)	1870 psi (129 bar)	1500 psi (103 bar)	1500 psi (103 bar)	1500 psi (103 bar)	1500 psi (103 bar)
System relief valve setting (at the power supply outlet)	2495 psi (172 bar)	2000 psi (138 bar)	2000 psi (138 bar)	2000 psi (138 bar)	2000 psi (138 bar)

**NOTE:** These are general hydraulic system requirements. See tool specification page for tool specific requirements

# OPERATION

## PREOPERATION PROCEDURES

### CHECK HYDRAULIC POWER SOURCE

1. Using a calibrated flowmeter and pressure gauge, check that the hydraulic power source develops a flow of 7-10 gpm/26-38 lpm at 1500-2000 psi/105-140 bar.
2. Make certain the hydraulic power source is equipped with a relief valve set to open at 2100-2250 psi/145-155 bar minimum.
3. Check that the hydraulic circuit matches the tool for open-center (OC) or closed-center (CC) operation.

### CHECK TOOL

1. Make sure all tool accessories are correctly installed. Failure to install tool accessories properly can result in damage to the tool or personal injury.
2. There should be no signs of leaks.
3. The tool should be clean, with all fittings and fasteners tight.

### CHECK TRIGGER MECHANISM

1. Check that the trigger operates smoothly and is free to travel between the "ON" and "OFF" positions.

### CHECK GUARD WELDMENT

1. Inspect the wheel guard weldment for cracks and other structural damage.

## INSTALLING AND REMOVING GRINDING WHEEL

**NOTE:** Use 6 inch diameter up to 3 inch thick (Type 6 for USA) grinding wheels with a 5/8-11 threaded arbor hole. Only use grinding wheels which comply with ANSI B7.1, B7.5/ISO 525, 603.

**READ AND BECOME FAMILIAR WITH THE SECTIONS IN THIS MANUAL ON SAFETY PRECAUTIONS, TOOL STICKERS AND TAGS, HYDRAULIC HOSE REQUIREMENTS, HYDRAULIC REQUIREMENTS, AND PREOPERATION PROCEDURES BEFORE USING THIS PRODUCT.**

### USA CONFIGURATION

1. Unscrew the two nuts (98) which secure the guard weldment (95) to the frame and remove the guard weldment.
2. Install the grinding wheel until it comes in contact with the drive flange.

3. Using the wrench (127) provided, place it on the flats of the drive flange. Place a strap wrench on the grinding wheel and then tighten by gripping and turning the strap wrench while holding the wrench provided.
4. Replace the guard weldment.

## WHEEL PIVOT ADJUSTMENTS FOR PROFILE OR FROG GRINDING OPERATIONS

**NOTE:** The PG05 does not contain the pivot wheels or the extension assembly.

### GRINDING WINGS

For grinding a wing of the frog, place the grinder on top of the wing with the rollers (91) resting on top of the wing to be ground. Adjust each wheel pivot (86) to the position shown in figure 1. Grinding is accomplished by moving the grinder back and forth in line with the rail. When finished with one wing, rotate the entire grinder 180 degrees and place it on the other wing.

## IMPORTANT

Never over-tighten the grinding wheel by impacting the wrench with a mallet or hammer. Sufficient torque is attained by hand-tightening the wheel with a strap wrench while securing the drive flange with the wrench provided.

# OPERATION

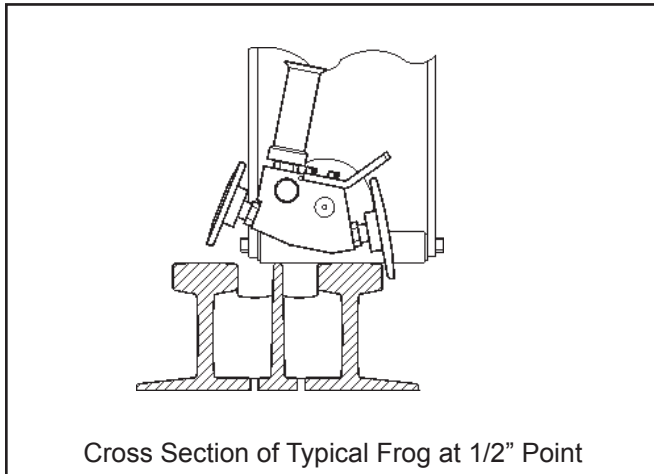

Cross Section of Typical Frog at 1/2" Point

Figure 1. Grinding the Wings of a Frog

## GRINDING THE POINT

For grinding the point of a frog, place the grinder on top of the point with the rollers (91) resting on the top of the point. Adjust each wheel pivot (86) to the position shown in figure 2. Grinding is accomplished by moving the grinder back and forth in line with the rail. It may be necessary to rotate the entire grinder 180 degrees and place it on the other side of the point in order to completely grind the width of the point. The extension assembly (128) is normally used during point grinding operations.

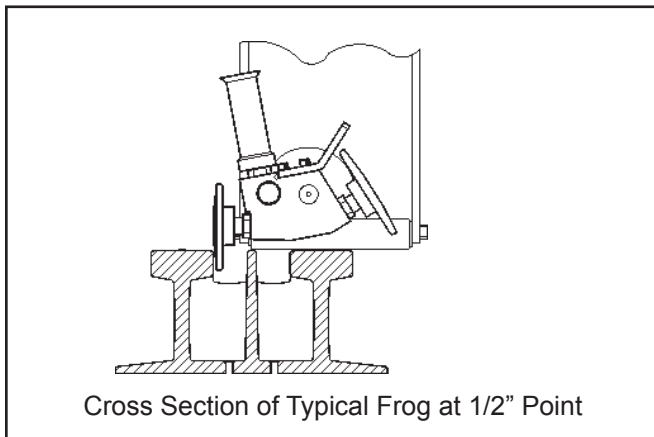

Cross Section of Typical Frog at 1/2" Point

Figure 2. Grinding the Point of a Frog

## PROFILE GRINDING

For profile grinding of rail, place the grinder on top of the rail with the rollers (91) resting on top of the rail to be ground. Adjust each wheel pivot (86) to the position shown in Figure 3. Grinding is accomplished by moving the grinder back and forth in line with the rail.

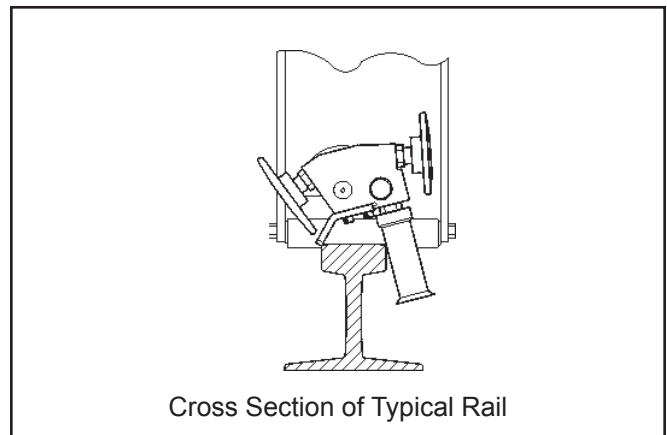

Cross Section of Typical Rail

Figure 3. Profile Grinding

## USING THE EXTENSION ASSEMBLY

The extension assembly (128) can be used at anytime by simply connecting it to one end of the grinder at the barrel nut (61) and clamping it in place by turning the adjustable handle (44).

## CONNECTING THE HOSES

1. Wipe all hose couplers with a clean lint-free cloth before making connections.
2. Connect the hoses from the hydraulic power source to the hose couplers on the grinder. It is a good practice to connect the return hose first and disconnect it last to minimize or avoid trapped pressure within the grinder motor.
3. Observe flow indicators stamped on hose couplers to be sure that oil will flow in the proper direction. The female coupler is the inlet coupler.

**NOTE: The pressure increase in uncoupled hoses left in the sun may result in making them difficult to connect. When possible, connect the free ends of operating hoses together.**

## OPERATING PROCEDURES

1. Observe all safety precautions.
2. Always start the grinder with the grinding wheel away from the work surface by turning the hand-wheel counter clockwise to raise the wheel.
3. Move the hydraulic circuit control valve to the "ON" position.
4. Squeeze the trigger momentarily. If the grinder does not operate, the hoses might be reversed. Verify correct connection of the hoses before continuing.
5. Start the grinder and move the grinding wheel to the work surface by turning the handwheel clockwise.

# OPERATION

6. Grind a small amount of material at a time adjusting the grinding wheel as necessary by turning the handwheel.

**Note: If the grinder is not loaded against a work surface when the trigger is released, the wheel will take 5-10 seconds to come to a complete stop. Avoid unintentional contact of the grinding wheel during the coast down period.**

## COLD WEATHER OPERATION

If the grinder is to be used during cold weather, preheat the hydraulic fluid at low engine speed. When using the normally recommended fluids, fluid temperature should be at or above 50° F/10° C (400 ssu/82 centistokes) before use.

Damage to the hydraulic system or grinder can result from use with fluid that is too viscous or too thick.

## PREVENTATIVE MAINTENANCE

1. The gears and bearings in the ram, spindle, and housing assemblies should be regreased every 6 months or 500 hours. This procedure must be accomplished by a trained technician.
2. After each servicing, measure the spindle speed (rpm - revolutions per minute) at 12 gpm/45 lpm input. The nominal speed is 4000, not to exceed 6000 rpm. This procedure must be accomplished by a trained technician.
3. Inspect the spindle and drive flange for signs of wear or damage. Runout should not exceed .004 in./1 mm TIR on threads or .002 in./0.05 mm TIR on arbor diameters and faces.
4. Check hoses and fittings weekly for any evidence of leakage, cover wear, cracking or cuts. If any of these defects are found, discontinue use of the tool immediately and have the defects repaired or replaced by a trained technician.
5. To grease between main housing bore (item 73) and the ram outer diameter (item 26) use **CAUTION** only one to two pumps of grease are required at these locations, excess grease will lockup feed assembly (See figure 4 below).

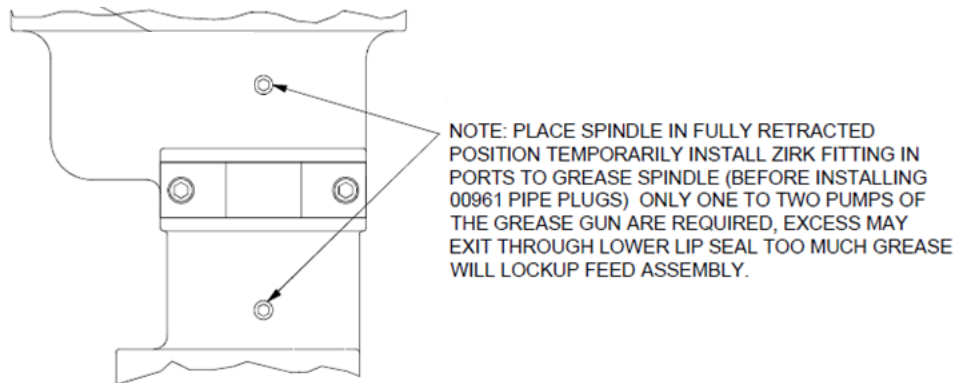

Figure 4

## TOOL PROTECTION & CARE

### NOTICE

In addition to the Safety Precautions found in this manual, observe the following for equipment protection and care.

- Make sure all couplers are wiped clean before connection.
- The hydraulic circuit control valve must be in the “OFF” position when coupling or uncoupling hydraulic tools. Failure to do so may result in damage to the quick couplers and cause overheating of the hydraulic system.
- Always store the tool in a clean dry space, safe from damage or pilferage.
- Make sure the circuit PRESSURE hose (with male quick disconnect) is connected to the “IN” port. The circuit RETURN hose (with female quick disconnect) is connected to the opposite port. Do not reverse circuit flow. This can cause damage to internal seals.
- Always replace hoses, couplings and other parts with replacement parts recommended by Stanley Hydraulic Tools. Supply hoses must have a minimum working pressure rating of 2500 psi/172 bar.
- Do not exceed the rated flow (see Specifications) in this manual for correct flow rate and model number. Rapid failure of the internal seals may result.
- Always keep critical tool markings, such as warning stickers and tags legible.
- Tool repair should be performed by experienced personnel only.
- Make certain that the recommended relief valves are installed in the pressure side of the system.
- Do not use the tool for applications for which it was not intended.

# TROUBLESHOOTING

If symptoms of poor performance develop, the following chart can be used as a guide to correct the problem.

When diagnosing faults in operation of the grinder, always check that the hydraulic power source is supplying the correct hydraulic flow and pressure to the grinder as listed in the table. Use a flowmeter known to be accurate. Check the flow with the hydraulic oil temperature at least 80°F/27°C.

PROBLEM	CAUSE	SOLUTION
Grinder does not run	Hydraulic power source not functioning.	Check power source for proper flow and pressure (7-10 gpm/ 26-38 lpm @ 1500-2000 psi/ 105-140 bar).
	Couplers or hoses blocked.	Locate and remove restriction.
	Hydraulic motor failure.	Inspect and repair.
	Hydraulic lines not connected.	Connect lines.
Grinder operates too slow.	Hydraulic motor speed too slow.	Check power unit for proper flow (7-10 gpm/26-38 lpm).
	High back-pressure.	Check hydraulic system for excessive back-pressure (over 250 psi/17 bar).
	Couplers or hoses blocked.	Locate and remove restriction.
	Oil too hot (above 140°F/60°C) or too cold (below 60°F/16°C).	Check hydraulic power source for proper oil temperature. Bypass cooler to warm oil or provide cooler to maintain proper temperature.
	Relief valve set too low.	Adjust relief valve to 2100-2250 psi/145-155 bar.
	Hydraulic motor worn.	Inspect, repair or replace.
	Flow control malfunctioning.	Have flow control serviced at an authorized Stanley service center.
Grinder operates too fast.	Flow control malfunctioning.	Have flow control and valve body serviced at an authorized Stanley service center.

# SPECIFICATIONS

Wheel Capacity .....	6 in. dia. x 3 in. thk x 5/8-11 threaded arbor (Type 6) U.S.A.
Pressure Range.....	1000-2000 psi/70-140 bar
Maximum Back Pressure.....	250 psi/17 bar
Flow Range .....	HTMA Type RR, 7-10 gpm/26-38 lpm
Porting .....	-8 SAE O-ring
Couplers .....	HTMA/EHTMA Flush Face Type Male & Female
Connect Size and Type .....	3/8 in. Male Pipe Adapter
Hose Whips .....	No
Weight (with couplers).....	90 lb/41 kg
Overall Length .....	44 inches/111.76 cm
Overall Width .....	10.5 inches/26.7 cm
Overall Height .....	32.5 inches/82.5 cm
RPM.....	4000
Hyrevz™ Motor .....	25251
Maximum Fluid Temperature .....	140° F/60° C
Sound Power Level .....	104 dBA
Sound Pressure Level (1m).....	94dBA
Vibration Level.....	Less than 2.5m/sec <sup>2</sup>

SOUND AND VIBRATION DECLARATION	
Test conducted on FG10110 S/N 527 operated at standard 10 gpm input	
Measured A-weighted sound power level, Lwa (ref. 1pW) in decibels	103.86 dBA
Uncertainty, Kwa, in decibels	3 dBA
Measured A-weighted sound pressure level, Lpa (ref. 20 µPa) at operator's position, in decibels	94 dBA
Uncertainty, Kpa, in decibels	3 dBA
Values determined according to noise test code given in ISO 15744, using the basic standard ISO3744 NOTE- The sum of a measured noise emission value and its associated uncertainty represents an upper boundary of the range of values which is likely to occur in measurements.	
Declared vibration emission value in accordance with EN 12096	
Measured vibration emission value: a	2.0 m/sec <sup>2</sup>
Uncertainty: K	0.5 m/sec <sup>2</sup>
Values determined according to ISO 8662-4, ISO 5349-1,2	

## ACCESSORIES

6 x 3 x 5/8-11 Thread Cup Stone.....	28597
--------------------------------------	-------





# FG10 - PG05 PARTS ILLUSTRATION

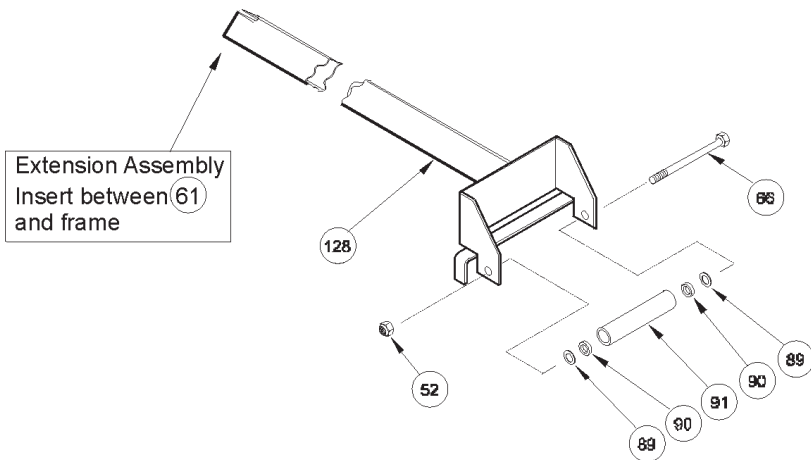
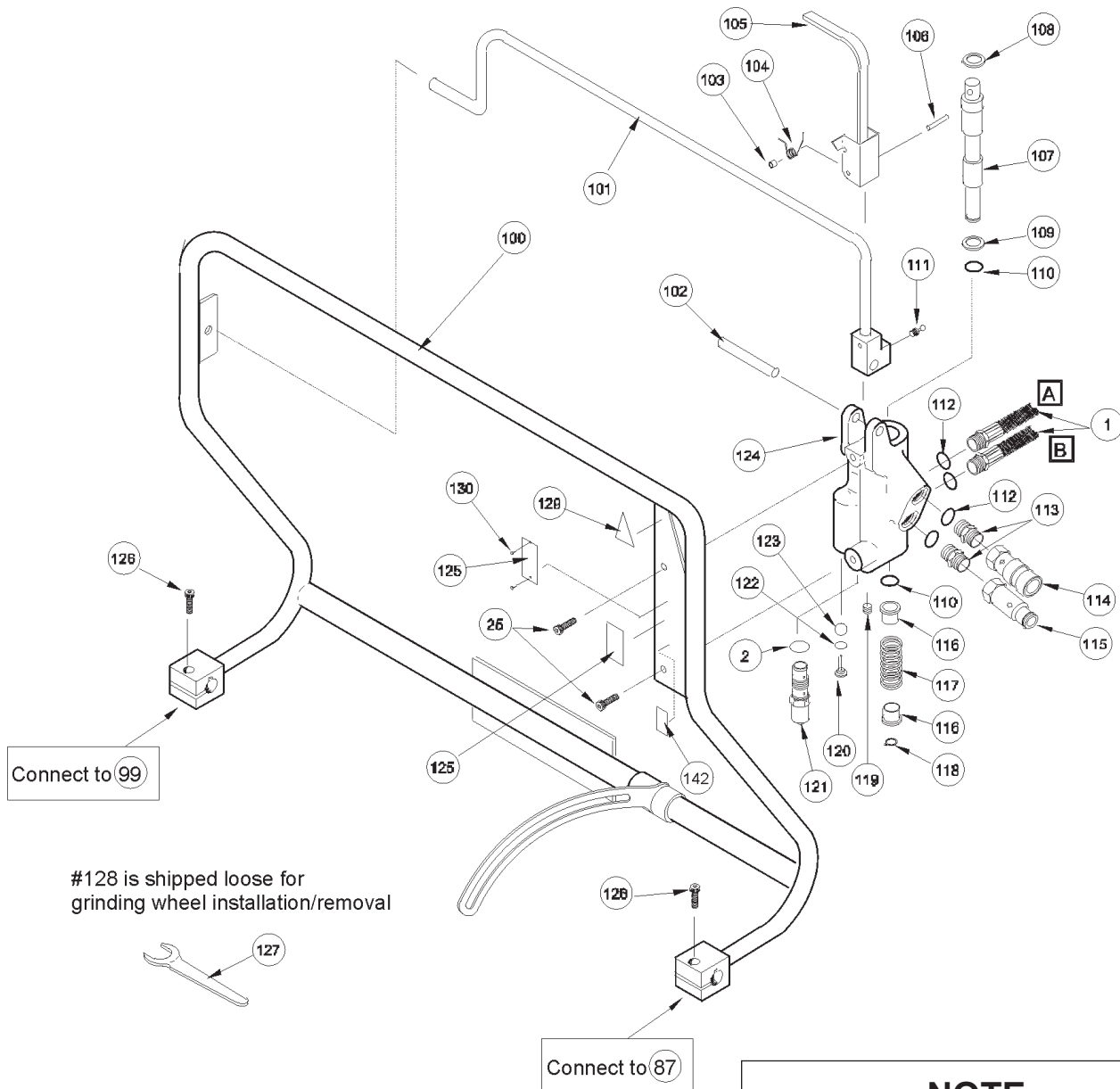

## NOTE

Some of the following item numbers are not included in the light weight model of the PG05 Profile Grinder

44	52	56	57	58
59	60	61	62	63
64	65	66	88	89
90	91	129		

# FG10 PARTS LIST

ITEM	P/N	QTY	DESCRIPTION
1	25294	2	HOSE ASSEMBLY
	25251	1	HYREVZ MOTOR ASSY (INCL ITEMS 4-15, 17, 18, & 20-23)
2	01604	3	O-RING •
3	25790	1	CAUTION STICKER (US MODELS)
4	00713	2	DOWEL PIN
5	25718	2	DRIVE GEARS
6	00178	1	O-RING, 2-1/8 X 2-1/4 X 1/16 70D •
7	06316	4	BUSHING
8	19905	1	FRONT BEARING HOUSING ASSY (INCL ITEM 7)
9	00669	1	QUAD RING •
10	19884	1	SEAL GLAND
11	00170	1	RETAINING RING
12	00148	1	BEARING
13	00166	1	RETAINING RING
14	00120	8	CAPSCREW
15	06846	1	GEAR HOUSING ASSEMBLY (INCL ITEMS 5 & 8)
16	25610	1	RAILROAD HELP DESK DECAL (US MODELS ONLY)
17	73309	1	IDLER SHAFT KEYED
19	28727	1	NAME TAG (US & CE MODELS)
20	00171	1	O-RING, 11/16 X 13/16 X 1/16 70D •
21	25166	1	MOTOR SHAFT
22	06881	2	NEEDLE ROLLER
23	00708	1	RETAINING RING
24	25158	1	SPLINED COUPLING
25	02688	10	CAPSCREW
26	25099	1	RAM
27	25291	1	NEEDLE ROLLER BEARING
28	25289	2	RETAINING RING
29	25290	1	INNER RING
30	25281	1	RETAINING RING
31	25279	1	BEARING
32	27941	1	SPINDLE
33	00772	2	WOODRUFF KEY
34	25278	1	RETAINING RING
35	25280	1	OIL SEAL, 1.250 X 2.047 X .299 •
36	25419	1	DRIVE FLANGE (US MODELS ONLY)
37	01607	1	SET SCREW
38	02179	1	NUT
39	26809	1	HAND WHEEL
40	25287	1	WIPER •
41	27748	1	BUSHING
42	27749	1	HOUSING
43	02900	1	ROLL PIN

ITEM	P/N	QTY	DESCRIPTION
44	25285	3	ADJUSTABLE HANDLE
45	25104	1	BACKUP WASHER
46	25286	1	WIPER TYPE H •
47	25293	1	SQUARE RING •
48	25103	1	THRUST WASHER
49	26810	1	SHAFT
50	25083	1	PINION GEAR
51	25283	1	ROLL PIN
52	03906	2	HEX NUT
53	02634	2	WASHER
54	00048	2	BEARING
55	26019	2	ROLLER
	26087	1	WHEEL ASSY 2.5 INCH (INCL ITEMS 56-58 & 62,63)
	26088	1	WHEEL ASSY 3.0 INCH (INCL ITEMS 56-58 & 62, 88)
56	03226	4	RETAINING RING
57	26042	4	WHEEL SHAFT
58	26091	4	BEARING
59	26250	2	JAM NUT
60	26216	2	ADJUSTMENT SCREW
61	26155	2	BARREL NUT
62	00664	4	RETAINING RING
63	26025	2	WHEEL, 2.5 INCH
64	26249	2	SPHERICAL WASHER (2 PCS)
65	00719	2	LOCKNUT
66	26202	2	CAPSCREW
67	00272	2	DOWEL PIN
68	25082	1	FEED GEAR
69	25284	1	DU BEARING
70	10888	2	CAPSCREW
71	25167	1	KEY
72	05152	1	STANLEY DECAL (US MODELS ONLY)
73	26103	1	MAIN HOUSING
74	26215	1	CHASSIS WELDMENT
75	00007	2	BEARING
76	26045	2	ROLLER SHAFT
77	26051	2	HANGER
78	03011	4	CAPSCREW
79	00635	2	KEY
80	26059	2	PIVOT PIN ASSY
81	00899	2	CAPSCREW
82	26831	2	WASHER
83	06989	4	O-RING, -018 •
84	26090	2	BUSHING
85	17668	2	ROLL PIN

# FG10 PARTS LIST

ITEM	P/N	QTY	DESCRIPTION
86	26056	2	WHEEL PIVOT
87	26022	1	PIVOT SHAFT WHEEL
88	26024	2	WHEEL, 3.3 INCH
89	12175	4	WASHER
90	26203	4	BALL BEARING
91	26046	2	ROLLER
92	26247	4	FLANGED BUSHING
93	01606	2	O-RING, -120 •
94	25277	1	WIPER •
95	26211	1	GUARD WELDMENT (US MODELS ONLY)
96	02525	3	CAPSCREW
97	26248	3	LOCK WASHER
98	26246	2	COUPLING NUT
99	26021	1	PIVOT SHAFT WHEEL
100	26098	1	HANDLE BAR ASSY
101	27369	1	TRIGGER WELDMENT
102	25292	1	ROLL PIN
103	27370	1	SPACER
104	27599	1	TORSION SPRING
105	27366	1	LEVER WELDMENT
106	18601	1	ROLL PIN
107	25036	1	ON-OFF VALVE, O.C.
108	25305	1	WIPER •
109	25256	1	WASHER
110	08017	2	O-RING, 7/8 X 1-1/16 X 3/32 -118 •
111	18037	1	BALL JOINT STUD
112	01605	4	O-RING, .644 X.818 X .087 -908 (INCL WITH ITEMS 114) •
113	00936	2	ADAPTER
114	03972	1	FEMALE COUPLING, PARKER
	47436	1	FEMALE COUPLING, AEROQUIP
115	03973	1	MALE COUPLING, PARKER
	47437	1	MALE COUPLING, AEROQUIP
116	18008	2	SPRING WASHER
117	24819	1	SPRING
118	17904	1	RETAINING RING
119	00955	1	PIPE PLUG
120	24289	1	PLUG
121	28914	1	FLOW CONTROL (PRE-SET)
122	01411	1	O-RING, .488 X .624 X .078 -906 •
123	20145	1	STEEL BALL
124	25005	1	VALVE BLOCK
125	03787	1	GPM DECAL (US MODELS ONLY)
	28811	1	INFORMATION PLAQUE (CE MODELS ONLY)

ITEM	P/N	QTY	DESCRIPTION
126	00144	2	CAPSCREW
127	25842	1	WRENCH (TAPED TO FRAME)
128	26142	1	EXTENSION BRACKET WELDMENT
	26200	1	EXTENSION ASSY (INCL 52, 66, 89-90, & 129)
129	11207	1	CIRCUIT "D" STICKER (CE MODELS ONLY)
130	372155	2	DRIVE SCREW
131	28409	1	COMPOSITE STICKER (CE MODELS ONLY)
132	28322	1	CE STICKER (CE MODELS ONLY)
133	---	-	NO ITEM
134	---	-	NO ITEM
135	---	-	NO ITEM
136	29052	1	INNER GUARD (SEE SPARK GUARD & INNER GUARD ILLUSTRATION PAGE FOLLOWING)
137	---	-	NO ITEM
138	---	-	NO ITEM
139	29264	1	SERVICE RAM ASSY (NOT SHOWN)
140	69772	1	SPARK GUARD (SEE SPARK GUARD & INNER GUARD ILLUSTRATION FOLLOWING)
141	08080	2	HANDLE GRIP
142	20647	1	104 SOUND POWER LEVEL DECAL
	25942	1	SEAL KIT

• Denotes part in seal kit

NOTE: Use Part Number and Part Name when ordering.

# PG05 PARTS LIST

ITEM	P/N	QTY	DESCRIPTION
1	25294	2	HOSE ASSEMBLY
	25251	1	HYREVZ MOTOR ASSY (INCL ITEMS 4-15, 17, 18, & 20-23)
2	01604	3	O-RING •
3	25790	1	CAUTION STICKER
4	00713	2	DOWEL PIN
5	25718	2	DRIVE GEARS
6	00178	1	O-RING, 2-1/8 X 2-1/4 X 1/16 70D •
7	06316	4	BUSHING
8	19905	1	FRONT BRG HSG ASSY (INCL ITEM 7)
9	00669	1	QUAD RING •
10	19884	1	SEAL GLAND
11	00170	1	RETAINING RING
12	00148	1	BEARING
13	00166	1	RETAINING RING
14	00120	8	CAPSCREW
15	06846	1	GEAR HOUSING ASSY (INCL ITEMS 4 & 7)
16	25610	1	RAILROAD HELP DESK DECAL
17	73309	1	IDLER SHAFT KEYED
19	29715	1	NAME TAG
20	00171	1	O-RING, 11/16 X 13/16 X 1/16 70D •
21	25166	1	MOTOR SHAFT
22	06881	2	NEEDLE ROLLER
23	00708	1	RETAINING RING
24	25158	1	SPLINED COUPLING
25	02688	10	CAPSCREW
26	25099	1	RAM
27	25291	1	NEEDLE ROLLER BEARING
28	25289	2	RETAINING RING
29	25290	1	INNER RING
30	25281	1	RETAINING RING
31	25279	1	BEARING
32	27941	1	SPINDLE
33	00772	2	WOODRUFF KEY
34	25278	1	RETAINING RING
35	25280	1	OIL SEAL, 1.250 X 2.047 X .299 •
36	25419	1	DRIVE FLANGE
37	01607	1	SET SCREW
38	02179	1	NUT
39	26809	1	HAND WHEEL
40	25287	1	WIPER •
ITEM	P/N	QTY	DESCRIPTION

41	27748	1	BUSHING
42	27749	1	HOUSING
43	02900	1	ROLL PIN
44	25285	1	ADJUSTABLE HANDLE
45	25104	1	BACKUP WASHER
46	25286	1	WIPER TYPE H •
47	25293	1	SQUARE RING •
48	25103	1	THRUST WASHER
49	26810	1	SHAFT
50	25083	1	PINION GEAR
51	25283	1	ROLL PIN
52	03906	2	HEX NUT
53	02634	2	WASHER
54	00048	2	BEARING
55	26019	2	ROLLER
56			NO ITEM
57			NO ITEM
58			NO ITEM
59			NO ITEM
60			NO ITEM
61			NO ITEM
62			NO ITEM
63			NO ITEM
64			NO ITEM
65			NO ITEM
66	26202	2	CAPSCREW
67	00272	2	DOWEL PIN
68	25082	1	FEED GEAR
69	25284	1	DU BEARING
70	10888	2	CAPSCREW
71	25167	1	KEY
72	05152	1	STANLEY DECAL
73	26103	1	MAIN HOUSING
74	26215	1	CHASSIS WELDMENT
75	00007	2	BEARING
76	26045	2	ROLLER SHAFT
77	26051	2	HANGER
78	03011	4	CAPSCREW
79	00635	2	KEY
80	26059	2	PIVOT PIN ASSY
81	00899	2	CAPSCREW
82	26831	2	WASHER
83	06989	4	O-RING, -018 •
84	26090	2	BUSHING
ITEM	P/N	QTY	DESCRIPTION

# PG05 PARTS LIST

85	17668	2	ROLL PIN
86	26056	2	WHEEL PIVOT
87	26022	1	PIVOT SHAFT WHEEL
88			NO ITEM
89	12175	4	WASHER
90	26203	4	BALL BEARING
91	26046	2	ROLLER
92	26247	4	FLANGED BUSHING
93	01606	2	O-RING, -120 •
94	25277	1	WIPER •
95	26211	1	GUARD WELDMENT
96	02525	3	CAPSCREW
97	26248	3	LOCK WASHER
98	26246	2	COUPLING NUT
99	26021	1	PIVOT SHAFT WHEEL
00	26098	1	HANDLE BAR ASSY
101	27369	1	TRIGGER WELDMENT
102	25292	1	ROLL PIN
103	27370	1	SPACER
104	27599	1	TORSION SPRING
105	27366	1	LEVER WELDMENT
106	18601	1	ROLL PIN
107	25036	1	ON-OFF VALVE, O.C.
108	25305	1	WIPER •
109	25256	1	WASHER
110	08017	2	O-RING, 7/8 X 1-1/16 X 3/32 -118 •
111	18037	1	BALL JOINT STUD
112	01605	4	O-RING, .644 X.818 X .087 -908 (INCL WITH ITEMS 114) •
113	00936	2	ADAPTER
114	03972	1	FEMALE COUPLING, PARKER
115	03973	1	MALE COUPLING, PARKER
116	18008	2	SPRING WASHER
117	24819	1	SPRING
118	17904	1	RETAINING RING
119	00955	1	PIPE PLUG
120	24289	1	PLUG
121	28914	1	FLOW CONTROL (PRE-SET)
122	01411	1	O-RING, .488 X .624 X .078 -906 •
123	20145	1	STEEL BALL
124	25005	1	VALVE BLOCK
125	03787	1	GPM DECAL
ITEM	P/N	QTY	DESCRIPTION
126	00144	2	CAPSCREW
127	25842	1	WRENCH (TAPED TO FRAME)

128	26142	1	EXTENSION BRACKET WELDMENT
	26200	1	EXTENSION ASSY (INCL 52, 66, 89-90, & 129)
129	---	-	NO ITEM
130	---	-	NO ITEM
131	---	-	NO ITEM
132	---	-	NO ITEM
133	---	-	NO ITEM
134	---	-	NO ITEM
135	---	-	NO ITEM
136	29052	1	INNER GUARD (SEE SPARK GUARD & INNER GUARD ILLUSTRATION PAGE FOLLOWING)
137	---	-	NO ITEM
138	---	-	NO ITEM
139	29264	1	SERVICE RAM ASSY (NOT SHOWN)
140	69772	1	SPARK GUARD (SEE SPARK GUARD & INNER GUARD ILLUSTRATION PAGE FOLLOWING)
141	08080	2	HANDLE GRIP
	25942	1	SEAL KIT

# SPARK GUARD & INNER GUARD

ITEM #	P/N	QTY	DESCRIPTION
1	00719	2	NYLOCK NUT
2	29920	2	CAPSCREW
3	02259	2	WASHER
4	69755	1	SPARK GUARD
5	69767	1	SPARK SCREEN
	69772	1	SPARK GUARD ASSY (INCLUDES ITEMS 1 THRU 5)

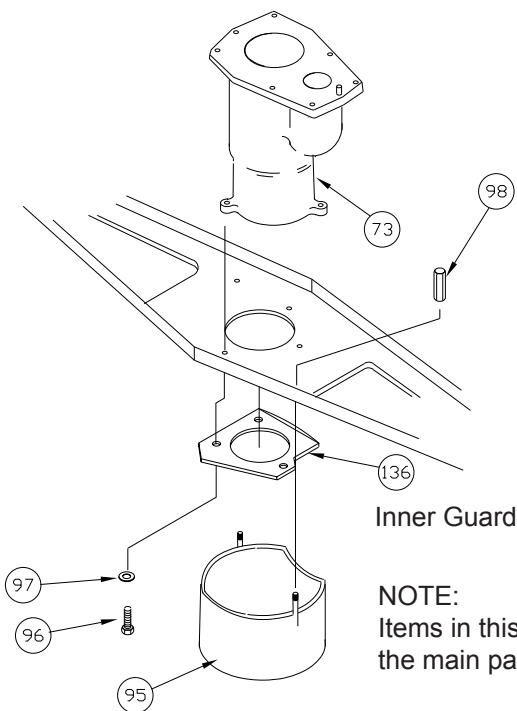
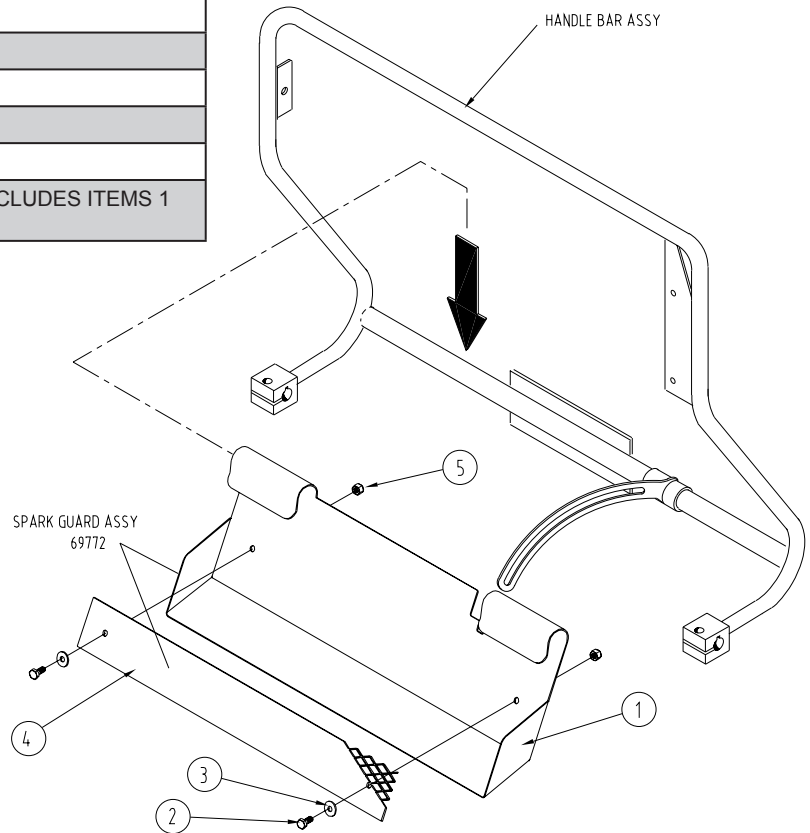

Inner Guard

NOTE:  
Items in this view can be found on  
the main parts list.





# **STANLEY®**

Stanley Hydraulic Tools  
3810 SE Naef Road  
Milwaukie, Oregon 97267-5698 USA  
(503) 659-5660 / Fax (503) 652-1780  
[www.stanleyhydraulics.com](http://www.stanleyhydraulics.com)