

STANLEY®

GT18B01 / GT18B02 HYDRAULIC POWER UNIT



USER MANUAL Safety, Operation and Maintenance



© 2014 Stanley Black & Decker, Inc.
New Britain, CT 06053
U.S.A.
65465 2/2015 Ver. 16

DECLARATION OF CONFORMITY

DECLARATION OF CONFORMITY
ÜBEREINSTIMMUNGS-ERKLÄRUNG
DECLARATION DE CONFORMITE CEE
DECLARACION DE CONFORMIDAD
DICHIARAZIONE DI CONFORMITA

STANLEY.
Hydraulic Tools
CE

I, the undersigned:
Ich, der Unterzeichnende:
Je soussigné:
El abajo firmante:
Io sottoscritto:

Weisbeck, Andy

Surname and First names/Familiennname und Vornamen/Nom et prénom/Nombre y apellido/Cognome e nome

hereby declare that the equipment specified hereunder:
bestätige hiermit, daß erklaren Produkt genannten Werk oder Gerät:
déclare que l'équipement visé ci-dessous:
Por la presente declaro que el equipo se especifica a continuación:
Dichiaro che le apparecchiature specificate di seguito:

1. Category: **Hydraulic Power Unit**
Kategorie:
Catégorie:
Categoria:
Categoria:
2. Make/Marke/Marque/Marca/Marca **Stanley**
3. Type/Typ/Type/Tipo/Tipo: **GT18B01, GT18B07**
4. Serial number of equipment:
Seriennummer des Geräts:
Numéro de série de l'équipement:
Numero de serie del equipo:
Matricola dell'attrezzatura:
- All**

Has been manufactured in conformity with
Wurde hergestellt in Übereinstimmung mit
Est fabriqué conformément
Ha sido fabricado de acuerdo con
E' stata costruita in conformità con

Directive/Standards Richtlinie/Standards Directives/Normes Directriz/Los Normas Direttiva/Norme	No. Nr Numéro No n.	Approved body Prüfung durch Organisme agréé Aprobado Collaudato
EN ISO	12100:2010	Self
Noise Directive ISO	2000/14/EC:2005 3744:2010	Self AkustikNet (Notified body ID 1585) Bagsvard Hovedgade 141, 2880 Bagsvard, Denmark Certificate #863/2011/001
Machinery Directive	2006/42/EC:2006	Self

6. Special Provisions: **None**
Spezielle Bestimmungen:
Dispositions particulières:
Provisiones especiales:
Disposizioni speciali:
7. Measurements: **Measured Sound Power Level 99 LwA**
Messungen **Guaranteed Sound Power Level 101 LwA**
Mesures **Measured in accordance to Directive 2000/14/EC,**
Mediciones **Noise related value: Installed Power 13,25 kW**
Misurazioni

8. Representative in the Union: **Patrick Vervier, Stanley Dubuis 17-19, rue Jules Berthonneau-BP 3406 41034 Blois Cedex, France.**
Vertreter in der Union/Représentant dans l'union/Representante en la Union/Rappresentante presso l'Unione

Done at/Ort/Fait à/Dado en/Fatto a Stanley Hydraulic Tools, Milwaukie, Oregon USA Date/Datum/le/Fecha/Data 7-21-11

Signature/Unterschrift/Signature/Firma/Firma

Andy Weisbeck

Position/Position/Fonction/Cargo/Posizione Director of Product Development

TABLE OF CONTENT

DECLARATION OF CONFORMITY.....	2
SAFETY SYMBOLS.....	4
SAFETY PRECAUTIONS.....	5
TOOL STICKERS & TAGS.....	6
HYDRAULIC HOSE TYPES.....	7
HOSE RECOMMENDATIONS.....	8
HTMA REQUIREMENTS.....	9
OPERATION.....	10
FOR 5 GPM OPERATION.....	12
FOR 8 GPM OPERATION.....	12
COLD WEATHER STARTUP.....	13
SHUTDOWN.....	13
ROUTINE MAINTENANCE.....	14
PROGRAMMABLE CONTROLLER.....	15
CHECKING PERFORMANCE CONTROL™ (ELECTRONIC GOVERNOR-STATIC CHECK).....	15
FAULT CODES.....	15
TESTING & TROUBLESHOOTING.....	17
GENERAL.....	17
TESTING THE HYDRAULIC CIRCUIT.....	17
TROUBLESHOOTING.....	18
SPECIFICATIONS.....	19
BRIGGS ENGINE ASSEMBLY.....	20
BRIGGS ENGINE PARTS LIST.....	21
FUEL TANK & CAP.....	22
FRAME PARTS.....	23
HOSES, FITTINGS & CLAMPS.....	24
MAIN POWER UNIT WIRING HARNESS.....	25

IMPORTANT

To fill out a Product Warranty Validation form, and for information on your warranty, visit Stanleyhydraulics.com and select the Company tab, Warranty.
(NOTE: The warranty Validation record must be submitted to validate the warranty).

SERVICING: This manual contains safety, operation, and routine maintenance instructions. Servicing of hydraulic tools, other than routine maintenance, must be performed by an authorized and certified dealer. Please read the following warning.

⚠ WARNING

SERIOUS INJURY OR DEATH COULD RESULT FROM THE IMPROPER REPAIR OR SERVICE OF THIS TOOL.

REPAIRS AND / OR SERVICE TO THIS TOOL MUST ONLY BE DONE BY AN AUTHORIZED AND CERTIFIED DEALER.

For the nearest authorized and certified dealer, call Stanley Hydraulic Tools at the number listed on the back of this manual and ask for a Customer Service Representative.

SAFETY SYMBOLS

Safety symbols and signal words, as shown below, are used to emphasize all operator, maintenance and repair actions which, if not strictly followed, could result in a life-threatening situation, bodily injury or damage to equipment.



This is the safety alert symbol. It is used to alert you to potential personal injury hazards. Obey all safety messages that follow this symbol to avoid possible injury or death.



This safety alert and signal word indicate an imminently hazardous situation which, if not avoided, will result in death or serious injury.



This safety alert and signal word indicate a potentially hazardous situation which, if not avoided, could result in death or serious injury.



This safety alert and signal word indicate a potentially hazardous situation which, if not avoided, could result in death or serious injury.



This signal word indicates a potentially hazardous situation which, if not avoided, may result in property damage.



This signal word indicates a situation which, if not avoided, will result in damage to the equipment.



This signal word indicates a situation which, if not avoided, may result in damage to the equipment.

Always observe safety symbols. They are included for your safety and for the protection of the tool.

LOCAL SAFETY REGULATIONS

Enter any local safety regulations here. Keep these instructions in an area accessible to the operator and maintenance personnel.

SAFETY PRECAUTIONS

Tool operators and maintenance personnel must always comply with the safety precautions given in this manual and on the stickers and tags attached to the equipment.

These safety precautions are given for your safety. Review them carefully before operating the tool and before performing general maintenance or repairs.

Supervising personnel should develop additional precautions relating to the specific work area and local safety regulations. If so, place the added precautions in the space provided on page 5.

In addition to this manual, read and understand safety and operating instructions in the Engine Operation Manual furnished with the power unit.

The Hydraulic Power Unit will provide safe and dependable service if operated in accordance with the instructions given in this manual. Read and understand this manual and any stickers and tags attached to the Power Unit. Failure to do so could result in personal injury or equipment damage.



- Operator must start in a work area without bystanders. The operator must be familiar with all prohibited work areas such as excessive slopes and dangerous terrain conditions.
- Establish a training program for all operators to ensure safe operation.
- Do not operate the power unit unless thoroughly trained or under the supervision of an instructor.
- Always wear safety equipment such as goggles, ear, head protection, and safety shoes at all times when operating the power unit and a hydraulic tool.
- Do not inspect or clean the power unit while it is running. Accidental engagement of the unit can cause serious injury.
- Always use hoses and fittings rated at 2500 psi/172 bar with a 4 to 1 safety factor. Be sure all hose connections are tight.

- Be sure all hoses are connected for correct flow direction to and from the tool being used.
- Do not inspect hoses and fittings for leaks by using bare hands. "Pin-hole" leaks can penetrate the skin.
- NEVER OPERATE THE POWER UNIT IN A CLOSED SPACE. Inhalation of engine exhaust can be fatal.
- Do not operate a damaged, improperly adjusted power unit.
- Never wear loose clothing that can get entangled in the working parts of the power unit.
- Keep all parts of your body away from the working parts of the power unit.
- Keep clear of hot engine exhaust.
- Do not add fuel to the power unit while the power unit is running or is still hot.
- Do not operate the power unit if gasoline odor is present.
- Do not use flammable solvents around the power unit engine.
- Do not operate the power unit within 3.3 ft/1 m of buildings, obstructions or flammable objects.
- Do not reverse tool rotation direction by changing fluid flow direction.
- Allow power unit engine to cool before storing in an enclosed space.
- Always keep critical tool markings, such as labels and warning stickers legible.
- To avoid personal injury or equipment damage, all tool repair, maintenance and service must only be performed by authorized and properly trained personnel.

TOOL STICKERS & TAGS



28322 CE Decal
GT18B01 Only

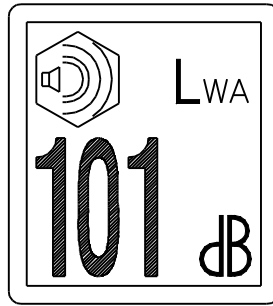

66653 Guaranteed
Sound Power Level
Decal
GT18B01 Only

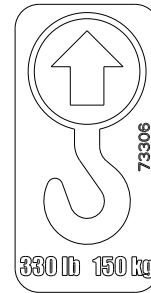

73306
Lift Point Decal
GT18B01 Only



62302 Power Unit Dash Decal

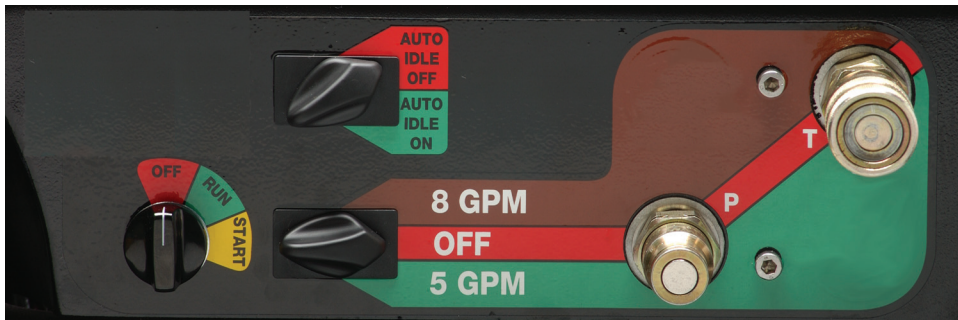

62300 Single Circuit Decal

HOSE TYPES

The rated working pressure of the hydraulic hose must be equal to or higher than the relief valve setting on the hydraulic system. There are three types of hydraulic hose that meet this requirement and are authorized for use with Stanley Hydraulic Tools. They are:

Certified non-conductive — constructed of thermoplastic or synthetic rubber inner tube, synthetic fiber braid reinforcement, and weather resistant thermoplastic or synthetic rubber cover. *Hose labeled **certified non-conductive** is the only hose authorized for use near electrical conductors.*

Wire-braided (conductive) — constructed of synthetic rubber inner tube, single or double wire braid reinforcement, and weather resistant synthetic rubber cover. *This hose is **conductive** and must never be used near electrical conductors.*

Fabric-braided (not certified or labeled non-conductive) — constructed of thermoplastic or synthetic rubber inner tube, synthetic fiber braid reinforcement, and weather resistant thermoplastic or synthetic rubber cover. *This hose is **not certified non-conductive** and must never be used near electrical conductors.*

HOSE SAFETY TAGS

To help ensure your safety, the following DANGER tags are attached to all hose purchased from Stanley Hydraulic Tools. **DO NOT REMOVE THESE TAGS.**

If the information on a tag is illegible because of wear or damage, replace the tag immediately. A new tag may be obtained from your Stanley Distributor.

THE TAG SHOWN BELOW IS ATTACHED TO “CERTIFIED NON-CONDUCTIVE” HOSE

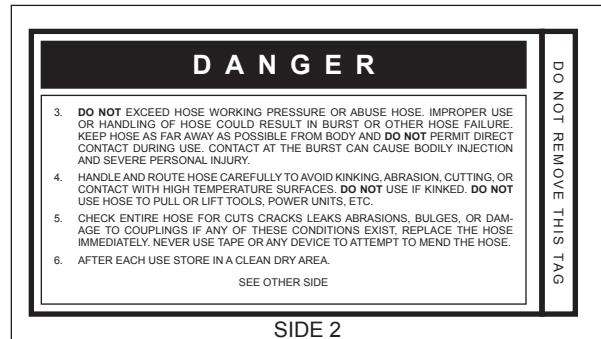
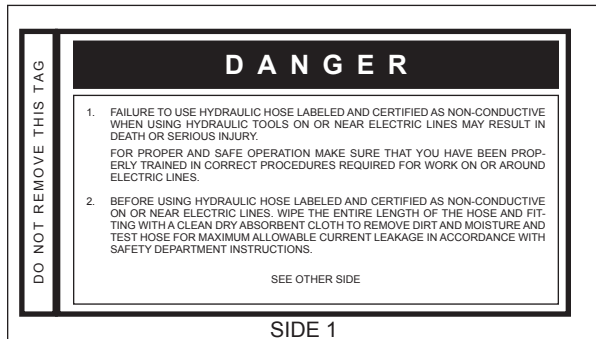

(Shown smaller than actual size)

THE TAG SHOWN BELOW IS ATTACHED TO “CONDUCTIVE” HOSE.

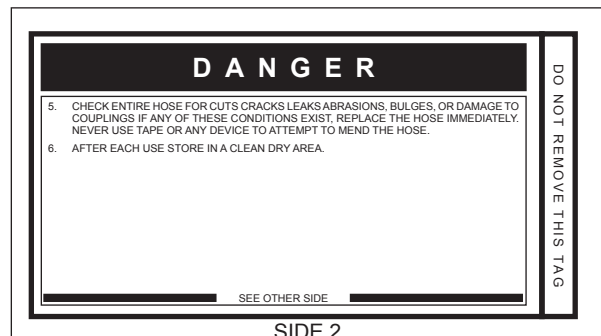
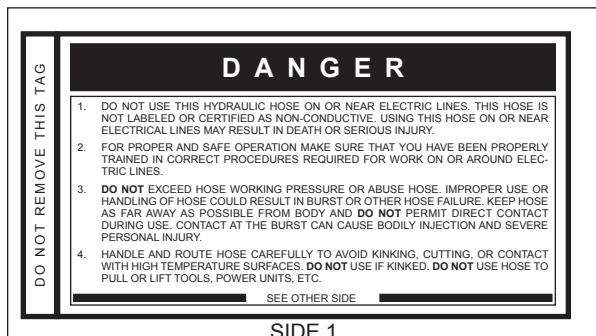

(Shown smaller than actual size)

HOSE RECOMMENDATIONS

Tool to Hydraulic Circuit Hose Recommendations

The chart to the right shows recommended minimum hose diameters for various hose lengths based on gallons per minute (gpm)/liters per minute (lpm). These recommendations are intended to keep return line pressure (back pressure) to a minimum acceptable level to ensure maximum tool performance.

This chart is intended to be used for hydraulic tool applications only based on Stanley Hydraulic Tools tool operating requirements and should not be used for any other applications.

All hydraulic hose must have at least a rated minimum working pressure equal to the maximum hydraulic system relief valve setting.

All hydraulic hose must meet or exceed specifications as set forth by SAE J517.

Oil Flow		Hose Lengths		Inside Diameter		USE (Press/Return)	Min. Working Pressure	
GPM	LPM	FEET	METERS	INCH	MM		PSI	BAR
Certified Non-Conductive Hose - Fiber Braid - for Utility Bucket Trucks								
4-9	15-34	up to 10	up to 3	3/8	10	Both	2250	155
Conductive Hose - Wire Braid or Fiber Braid - DO NOT USE NEAR ELECTRICAL CONDUCTORS								
4-6	15-23	up to 25	up to 7.5	3/8	10	Both	2500	175
4-6	15-23	26-100	7.5-30	1/2	13	Both	2500	175
5-10.5	19-40	up to 50	up to 15	1/2	13	Both	2500	175
5-10.5	19-40	51-100	15-30	5/8	16	Both	2500	175
5-10.5	19-40	100-300	30-90	5/8	16	Pressure	2500	175
10-13	38-49	up to 50	up to 15	3/4	19	Return	2500	175
10-13	38-49	51-100	15-30	5/8	16	Both	2500	175
10-13	38-49	100-200	30-60	3/4	19	Pressure	2500	175
13-16	49-60	up to 25	up to 8	5/8	16	Return	2500	175
13-16	49-60	26-100	8-30	3/4	19	Return	2500	175
				1	25.4	Return	2500	175
				5/8	16	Pressure	2500	175
				3/4	19	Return	2500	175
				3/4	19	Pressure	2500	175
				1	25.4	Return	2500	175

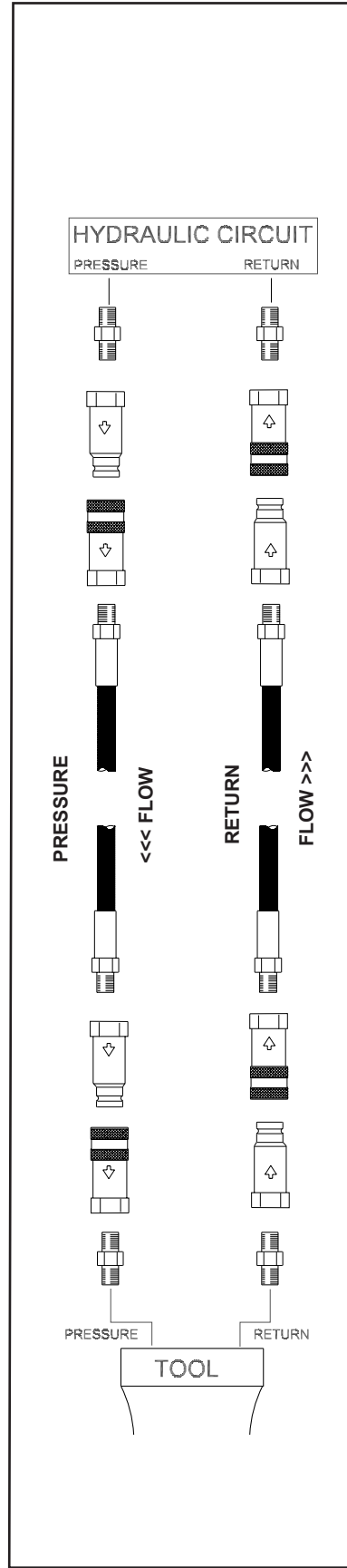

Figure 1. Typical Hose Connections

HTMA / EHTMA REQUIREMENTS

HTMA / EHTMA REQUIREMENTS

HTMA

HYDRAULIC SYSTEM REQUIREMENTS

TOOL TYPE

TYPE I

TYPE II

TYPE RR

TYPE III

Flow Range	4-6 gpm (15-23 lpm)	7-9 gpm (26-34 lpm)	9-10.5 gpm (34-40 lpm)	11-13 gpm (42-49 lpm)
Nominal Operating Pressure (at the power supply outlet)	1500 psi (103 bar)	1500 psi (103 bar)	1500 psi (103 bar)	1500 psi (103 bar)
System relief valve setting (at the power supply outlet)	2100-2250 psi (145-155 bar)	2100-2250 psi (145-155 bar)	2200-2300 psi (152-159 bar)	2100-2250 psi (145-155 bar)
Maximum back pressure (at tool end of the return hose)	250 psi (17 bar)	250 psi (17 bar)	250 psi (17 bar)	250 psi (17 bar)
Measured at a max. fluid viscosity of: (at min. operating temperature)	400 ssu* (82 centistokes)	400 ssu* (82 centistokes)	400 ssu* (82 centistokes)	400 ssu* (82 centistokes)
Temperature: Sufficient heat rejection capacity to limit max. fluid temperature to: (at max. expected ambient temperature)	140° F (60° C)	140° F (60° C)	140° F (60° C)	140° F (60° C)
Min. cooling capacity at a temperature difference of between ambient and fluid temps	3 hp (2.24 kW) 40° F (22° C)	5 hp (3.73 kW) 40° F (22° C)	6 hp (5.22 kW) 40° F (22° C)	7 hp (4.47 kW) 40° F (22° C)
NOTE: Do not operate the tool at oil temperatures above 140° F (60° C). Operation at higher temperatures can cause operator discomfort at the tool.				
Filter Min. full-flow filtration Sized for flow of at least: (For cold temp. startup and max. dirt-holding capacity)	25 microns 30 gpm (114 lpm)	25 microns 30 gpm (114 lpm)	25 microns 30 gpm (114 lpm)	25 microns 30 gpm (114 lpm)
Hydraulic fluid Petroleum based (premium grade, anti-wear, non-conductive) Viscosity (at min. and max. operating temps)	100-400 ssu*	100-400 ssu* (20-82 centistokes)	100-400 ssu*	100-400 ssu*
NOTE: When choosing hydraulic fluid, the expected oil temperature extremes that will be experienced in service determine the most suitable temperature viscosity characteristics. Hydraulic fluids with a viscosity index over 140 will meet the requirements over a wide range of operating temperatures.				
*SSU = Saybolt Seconds Universal				

EHTMA HYDRAULIC SYSTEM REQUIREMENTS

CLASSIFICATION

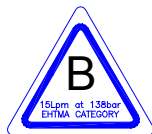

Flow Range	3.5-4.3 gpm (13.5-16.5 lpm)	4.7-5.8 gpm (18-22 lpm)	7.1-8.7 gpm (27-33 lpm)	9.5-11.6 gpm (36-44 lpm)	11.8-14.5 gpm (45-55 lpm)
Nominal Operating Pressure (at the power supply outlet)	1870 psi (129 bar)	1500 psi (103 bar)	1500 psi (103 bar)	1500 psi (103 bar)	1500 psi (103 bar)
System relief valve setting (at the power supply outlet)	2495 psi (172 bar)	2000 psi (138 bar)	2000 psi (138 bar)	2000 psi (138 bar)	2000 psi (138 bar)

NOTE: These are general hydraulic system requirements. See tool specification page for tool specific requirements

OPERATION

PREPARATION FOR USE

Do not operate the power unit until you have read the engine operating and maintenance instructions manual furnished with the unit.

1. ENGINE CRANKCASE OIL LEVEL

Always check the oil level before starting the engine. Make sure the oil level is at the FULL MARK on the dipstick. Do not overfill. Use detergent oil classified "For Service SE, SF, SG" as specified in the engine operating and maintenance manual. See engine manual for oil viscosity grade.

2. SPARK PLUG

On power units equipped with Briggs & Stratton Engines, ONLY Champion RC12YC or equivalent can be used.

Incorrect type spark plugs can produce radio frequency interference that will corrupt and damage the controller. Failure to use the correct spark plug could result in a warranty that will not be considered.

3. ENGINE FUEL LEVEL

Check the fuel level. If low, fill with un-leaded gasoline with a minimum of 85 octane.

4. HYDRAULIC FLUID

RECOMMENDED HYDRAULIC OILS

Below is a list of recommended oils by brand.

Brand	Biodegradable	Description
CITGO	No	Hydurance AW32
AMS Oil	No	HVH 32
Exxon Mobil	No	Unavis HVI26*
Exxon Mobil	No	DTE 10 Excel
Shell	No	S2 V 32
Chevron	No	Rando HDZ 32
Conoco Phillips	No	Unax AW-WR-32
Clarion (CITGO)	Yes	Green Bio 32
Exxon Mobil	Yes	EAL 224H
Chevron	Yes	Clarity AW32
Terresolve	Yes	Envirologic 132
Shell	Yes	Naturelle HF-E-32

*Recommended for extreme cold temperatures

5. HYDRAULIC CONNECTIONS

The recommended hose length is 25 ft/8 m with a 1/2 inch/12.7 mm inside diameter. The hoses must have a working pressure rating of at least 2500 psi/175 bar. Each hose end must have male thread ends compatible with H.T.M.A. (HYDRAULIC TOOL MANUFACTURERS ASSOCIATION) quick disconnect fittings (NPT type threads). (See Figure 2.)

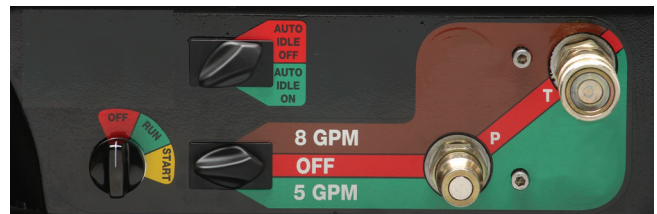

Figure 1. Control Panel

Facing the control panel, the bottom male quick disconnect fitting is the PRESSURE FLUID OUT fitting. The top female quick disconnect fitting is the RETURN FLUID IN fitting.

OPERATION

QUICK DISCONNECT COUPLERS

H.T.M.A. approved quick disconnect couplings are installed to hydraulic hoses so that the direction of oil flow is always from the male to the female quick disconnect as shown in figure 2. Quick disconnect couplings and hose fittings are selected so that additional fittings such as reducer or adapter fittings are not required.

If adapter fittings are used, they must be approved steel hydraulic fittings meeting a minimum operating pressure rating of 2500 psi/172 bar. Do not use galvanized pipe fittings or black pipe fittings.

Use thread tape or pipe joint compound when installing quick disconnect couplings to hose or tool fittings. Follow the instructions furnished with the selected thread sealant. **DO NOT OVERTIGHTEN THE FITTINGS.**

6. BATTERY

NOTICE

Do not charge the battery with a standard automotive battery charger. This type of charger produces a charging amperage higher than 2 amps. Charging the battery at higher than 2 amps will damage the battery.

NOTICE

If the engine runs out of gas or dies during operation and the ignition switch is left in the ON or RUN position, this could drain the battery. Make sure the ignition switch is returned to the OFF position.

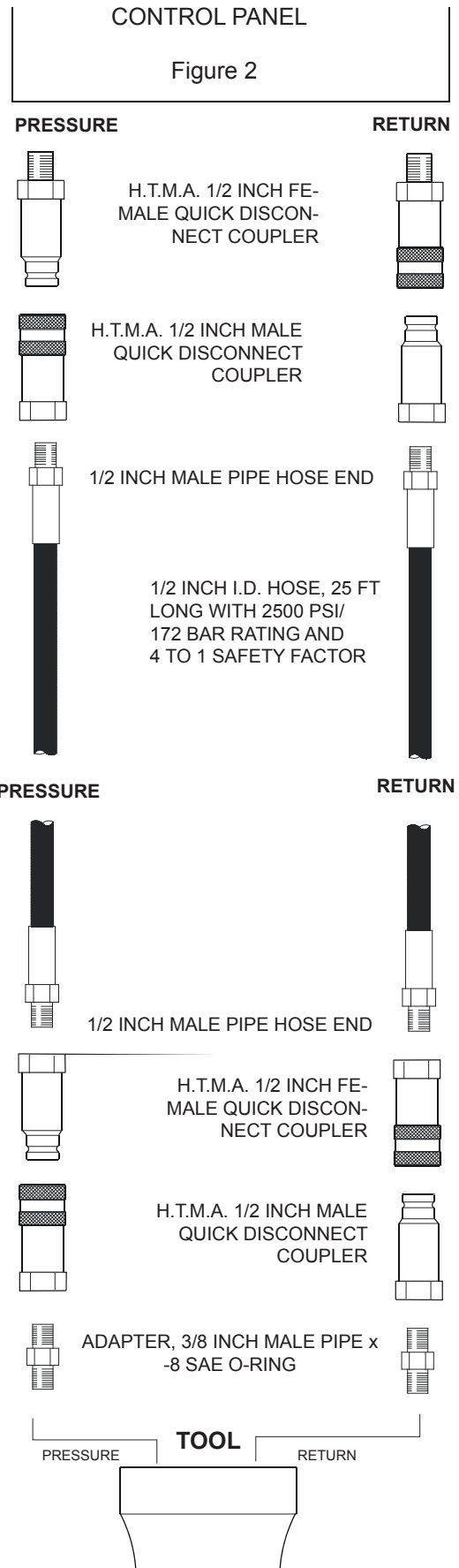

OPERATION

CONTROLS

This unit is equipped with an advanced proportional engine control system. It provides a means of controlling engine speed by adjusting the fuel control lever with an actuator. The Power Unit provides one circuit, with an oil flow of 5 gpm/19 lpm up to 2000 psi/140 bar or 8 gpm/30 lpm up to 2000 psi/140 bar with a factory-programmed electronic governed engine throttle.

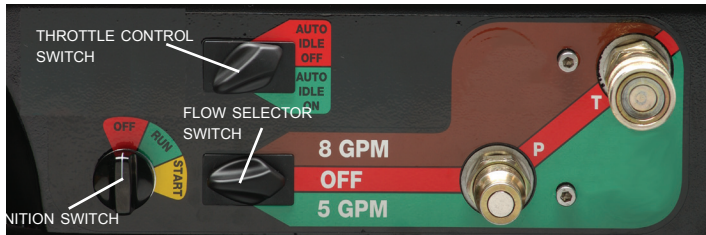

Figure 3. Control Panel

One hydraulic tool can be connected to the tool circuit. The circuit is activated by turning the flow control switch to either the 5 gpm/19 lpm or 8 gpm/30 lpm setting.

THROTTLE CONTROL

The throttle control permits the operator to select one of 2 operating modes after the engine has warmed up. When starting the engine, make sure the flow selector switch is in the off position. The throttle control switch can be set in either the auto-idle-on or auto-idle-off positions.

AUTO-ON

When the throttle control switch is in the "AUTO-ON" position, the oil flow is regulated automatically when the trigger on the tool is activated. When the tool is not being used the engine will return to idle automatically, after a 10 second delay.

This setting will produce 5 gpm/19 lpm or 8 gpm/30 lpm depending on which position the operator has selected with the flow selector switch.

AUTO-OFF

When the throttle control switch is in the "AUTO-OFF" position, the engine speed is held to maintain 5 gpm/19 lpm or 8 gpm/30 lpm depending on which position the operator has selected with the flow selector switch. When a tool is not being used the engine will not return to idle until either the flow selector switch is turned to the off position or the throttle control switch is turned to auto-on.

Note:

It may be necessary to reset the Controller.

At times it may be necessary to reset the controller. This could happen if a fault occurs in the controller. For example, excessive engine speed. If a fault does occur the power unit will return to an idle and the operator will have no control of the unit. To reset the controller, simply turn off the power unit and restart it.

STARTUP

Before starting the engine make sure the flow selector switch is in the OFF position.

Note:

The power unit will not start if the flow control switch is not in the "OFF" position.

Pull choke knob out and move the Throttle Control Switch to the auto-idle-off or the auto-idle-on position, whichever mode of operation the operator prefers. Ensure the flow selector switch is in the OFF position.

Turn the Ignition Switch to the START position. After the engine starts, release the switch.

Gradually push in the choke knob as the engine begins to idle smoothly.

Allow the engine to warm up.

Connect hoses and the tool as described in this manual.

FOR 5 GPM OPERATION

For 5 gpm operation, select mode of operation with the Throttle Control switch, either auto-idle-on or the auto-idle-off position. Move the flow selector switch to the 5 gpm position.

When finished operating the tool, move the flow selector switch to the OFF position.

FOR 8 GPM OPERATION

For 8 gpm operation, select mode of operation with the Throttle Control Switch, either auto-idle-on or the auto-idle-off position. Move the flow selector switch to the 8 gpm position.

When finished operating the tool, move the flow selector switch to the OFF position.

OPERATION

COLD WEATHER STARTUP

1. Use the procedures described under "STARTUP" and then follow the procedure below.
2. Hydraulic fluids are thicker in cold weather. Therefore, it is recommended that the engine be run at low idle long enough to bring the fluid temperature up to a minimum of 50°F/10°C.
3. If the tools and tool hoses are cold, it is recommended to allow hydraulic fluid to circulate through the tool hoses until warm before using the tool.

SHUTDOWN

1. Ensure the flow selector switch in the OFF position (center position).
2. Unless already at idle the power unit should return to idle. This may take a few seconds for the unit to react due to a built-in program delay.
3. Allow the engine to idle for approximately one minute and move the Ignition Switch to the OFF position.

ROUTINE MAINTENANCE

ENGINE MAINTENANCE

Follow the maintenance schedule and general maintenance instructions in the engine maintenance and operation manual furnished with the power unit.

SPARK PLUG

On power units equipped with Briggs & Stratton Engines, ONLY Champion RC12YC or equivalent can be used.

Incorrect type spark plugs can produce radio frequency interference that will corrupt and damage the controller. Failure to use the correct spark plug could result in a warranty that will not be considered.

HYDRAULIC SYSTEM MAINTENANCE

- Check hydraulic fluid level daily. Add fluid per specifications in this manual. (See "HYDRAULIC FLUID" under the section titled "OPERATING INSTRUCTIONS".
- Remove condensed moisture from the hydraulic fluid by pumping the hydraulic fluid into a 5 gal/20 l container through the pressure hose. Make sure the engine is at idle when performing this procedure. When the hydraulic reservoir is empty turn the engine off immediately.
- Allow the fluid to sit long enough for the water to settle to the bottom of the container. Slowly pour the fluid back into the hydraulic tank, avoiding the water at the bottom of the container.
- Each day, check hydraulic lines and fittings for leaks, kinks, etc. Do not use your hand to perform this check.

- Change the hydraulic filter element every 200 hours of operation. Change more often if cold, moist or dusty conditions exist.

- Check oil cooler for debris. Remove debris with air pressure.

STORAGE

- Clean the unit thoroughly before storage. Do not use water pressure.
- Always store the unit in a clean and dry facility.
- If the unit will be stored for a prolonged period (over 30 days), add a fuel additive to the fuel tank to prevent the fuel from gumming. Run engine for a short period to circulate the additive.
- Replace crankcase oil with new oil.

PROGRAMMABLE CONTROLLER

The Stanley programmable controller is an electronic engine governor that provides a means of controlling and limiting engine speed by adjusting the fuel control lever with a proportional actuator.

The controller is factory preset and has no manual adjustments.

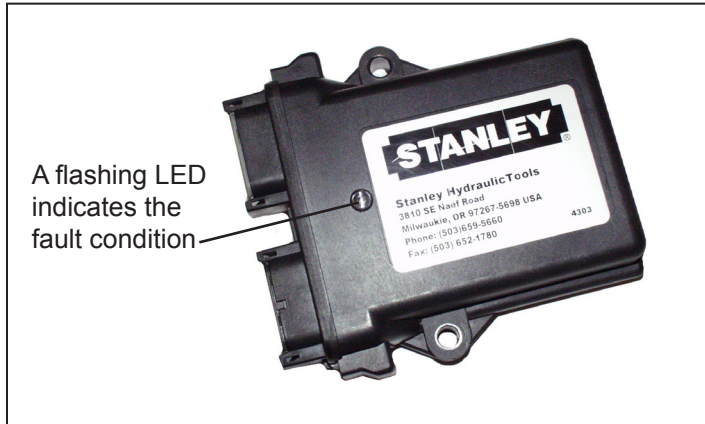

TROUBLESHOOTING GUIDELINES

Please follow the checklist below to troubleshoot your Stanley controller.

1. Check battery voltage for stability and correct value. The LED will turn on for one second when the controller 4500 is first powered up.
2. Check the actuator linkage for binding and backlash.

Checking Performance Control™ (Electronic Governor-Static Check)

To determine whether a governor problem is being caused by the actuator or the control module, perform the following static check exactly in order shown.

A pair of jumper wires and a known good 12-volt battery is required.

1. Disconnect red and green wires from the control module to actuator.
2. Attach jumper wires from battery to RED and GREEN wires to actuator.
 - a. Attach 12 volt + (positive) to RED wire.
 - b. Attach 12 volt – (negative) to GREEN wire.
3. Actuator should move throttle lever to wide open position.

- a. If actuator does not move it is defective. (Replace).
- b. If actuator moves throttle to wide-open position, the module is defective. (Replace).

FAULT CODES

The Stanley controller is capable of identifying certain fault conditions and alerting the user to them. A flashing LED indicates the fault conditions. The current fault code list is shown on the following page. Please note the following:

1. When power is first applied to the controller, the LED will flash just once for one second to indicate that the LED is working.
2. If there are multiple faults, the LED will flash them all in sequence. Count the flash codes to determine the fault conditions or connect the Calibration Tool to observe the fault conditions. (Use the “Display Faults” option under the Monitor Menu.)
3. If there are no faults, the LED will flash once at reset and from then on indicate the detection of engine speed. A continuous ON LED indicates that a valid engine speed is being sensed.
4. The controller will attempt to shut down for some faults and will not permit starting after reset with faults 1, 5 and 8.

FAULT CODES

FLASH CODE	FAULT	ENGINE SHUTDOWN	CORRECTIVE ACTION
1	APECS unit not calibrated	yes	Have engine serviced by an Authorized Stanley Dealer.
2	Engine speed excessive	yes	Have engine serviced by an Authorized Stanley Dealer.
3	Engine speed unusually low	yes	Have engine serviced by an Authorized Stanley Dealer.
4	Engine shutdown due to engine protection input	yes	Have engine serviced by an Authorized Stanley Dealer.
5	Factory settings lost	yes	Have engine serviced by an Authorized Stanley Dealer.
6	External pot out-of-range	no	Have engine serviced by an Authorized Stanley Dealer.
7	Accelerator position / idle switch conflict	no	Have engine serviced by an Authorized Stanley Dealer.
8	Controller unit failed	yes	Have engine serviced by an Authorized Stanley Dealer.
9	Limiting excessive actuator current	no	Have engine serviced by an Authorized Stanley Dealer.
10	Engine speed input signal missing	no	(Active only in Auto crank mode). Check speed sensor wiring. Check starter motor.
11	Auto crank unable to start engine	no	Check fuel.
12	Auxiliary output is shorted	no	Check the lamp or relay hooked to the output. If fault is still present, have engine serviced by an authorized Stanley Dealer.
13	Auxiliary output #2 is shorted	no	Check the lamp or relay hooked to the output. If fault is still present, have engine serviced by an authorized Stanley dealer.
14	Actuator disconnected or open circuit	no	Check actuator wiring and actuator resistance. Resistance should be less than 10 ohms.

TESTING & TROUBLESHOOTING

GENERAL

Tests and adjustments should be performed periodically to ensure the power unit is operating at maximum efficiency. Stanley Circuit Tester (part number 04182) is recommended. This tester can be used to isolate problems in both the engine and hydraulic system prior to any power unit disassembly.

TESTING THE HYDRAULIC CIRCUIT

The following tests can be performed to ensure that the hydraulic pump is supplying the correct flow and pressure and that the system relief valve is operating properly.

During these tests, make sure the engine is warm and operating smoothly. If test results are not as specified, refer to the troubleshooting table in this section for possible causes.

Testing The 5 gpm htma type I circuit or the 8 gpm type II circuit

To test the circuit, proceed as follows:

1. Set the flow selector switch to the OFF (center) position.
2. Set the throttle control switch to AUTO-OFF position.
3. Connect the Stanley Circuit Tester across two hose ends (where the tool would normally be connected).
4. Fully open the tester restrictor valve (counterclockwise).
5. Start the engine and allow it to run until warm.
6. Switch the flow selector switch to 5 or 8 gpm depending on which flow you are testing.
7. With the engine at the programmed speed, the test flow gauge should read 4-6 gpm/15-23 lpm or 7-9 gpm/26.5-34 lpm.
8. Slowly turn the restrictor valve clockwise while watching the pressure gauge. The flow rate should stay at 4-6 gpm/15-23 lpm or 7-9 gpm/26.5-34 lpm as the pressure gauge reaches 2100-2200 psi/148-155 bar.

9. At 2100-2200 psi/148-155 bar, the relief valve should begin to open. The pressure at which the relief valve just begins to open is commonly referred to as the "cracking pressure". At the "cracking pressure," the flow rate should start to drop because the relief valve is allowing fluid to bypass to the hydraulic reservoir. The "cracking pressure" is preset at the factory and if it is not within the above range, the relief valve must be re-set as follows:

- a. The relief valve is located on the right side of the unit just behind the dash panel. It protrudes out from the manifold assembly. Use an open end or box end wrench to loosen the nut on the relief valve.
- b. Use an Allen wrench to adjust the relief valve. Turn clockwise to raise the pressure and counterclockwise to reduce the pressure.
- c. Tighten the nut and retest.

TROUBLESHOOTING

PROBLEM	CAUSE	REMEDY
ENGINE WILL NOT START.	FLOW SELECTOR SWITCH NOT IN THE OFF POSITION.	MAKE SURE THE FLOW SELECTOR SWITCH IS IN THE OFF POSITION WHEN STARTING.
	BATTERY NOT CONNECTED.	ATTACH BATTERY CABLES, CHECK WIRES.
	WEAK BATTERY.	TEST BATTERY, CHARGE OR REPLACE.
	NO FUEL.	ADD FUEL.
	FUEL FILTER PLUGGED.	REPLACE FUEL FILTER.
	DEFECTIVE SPARK PLUGS.	REMOVE PLUGS, CHECK GAP, CLEAN OR REPLACE.
FLUID BLOWING OUT OF FLUID RESERVOIR VENT.	HYDRAULIC TANK OVERFILLED.	CORRECT THE FLUID LEVEL.
	PUMP SUCTION LEAK.	CHECK SUCTION CONNECTIONS. TIGHTEN IF NECESSARY.
HYDRAULIC TOOL WON'T OPERATE	FLOW SELECTOR SWITCH NOT SWITCHED ON.	CHECK THAT THE FLOW SELECTOR SWITCH IS SET TO 5 OR 8 GPM.
	INCORRECT HOSE CONNECTION TO TOOL.	MAKE SURE THE TOOL HOSE CIRCUIT GOES FROM LEFT (PRESSURE) FITTING TO TOOL AND BACK TO THE RIGHT FITTING (RETURN). FLUID ALWAYS FLOWS FROM THE MALE TO FEMALE FITTINGS.
	QUICK DISCONNECT FITTINGS DEFECTIVE.	DETACH FROM HOSE, CONNECT SET TOGETHER AND CHECK FOR FREE FLOW.
	HYDRAULIC FLUID LEVEL LOW.	CHECK FOR CORRECT FLUID LEVEL. FILL USING THE RECOMMENDED FLUID.
	PUMP COUPLING DEFECTIVE.	WITH THE ENGINE NOT RUNNING. CHECK THE COUPLING BETWEEN THE PUMP AND ENGINE THAT IT IS ENGAGED AND IS NOT DAMAGED. CAUTION: KEEP HANDS CLEAR OF ROTATING OBJECTS.
	RELIEF VALVE STUCK OPEN.	ADJUST OR REPLACE VALVE.
	SUCTION HOSE KINKED.	MAKE SURE SUCTION HOSE FROM FLUID RESERVOIR TO PUMP INLET HAS A SMOOTH CURVE.
	SOLENOID NOT WORKING.	CHECK SOLENOID OPERATION AND ELECTRICAL CONNECTIONS
	TOOL IS DEFECTIVE.	REFER TO TOOL MANUAL.

SPECIFICATIONS

Engine: 18 hp Briggs

Capacity..... One 5 gpm/19 lpm Circuit or One 8 gpm/30 lpm Circuit

Length:..... 36 in. / 91.4 cm

Width: 23 in. / 58.4 cm

Height: 29.5 in. / 74.9cm

Weight (Wet): Single Circuit Briggs330 lbs / 149.6 kg

Fuel Tank Capacity: 5.5 gal. / 20.8 ltr

Estimated Gas Consumption Per Hour 1.3 gal / 4 ltr

Hydraulic Reservoir Capacity: 3 gal. / 11 ltr

Relief Valve "crack" setting 2100 psi / 145 bar

Max relief setting 2500 psi / 172 bar

HTMA/EHTMA Category Type 1 and 2



Nominal Pressure 1500 psi/103 bar

Max Pressure 2000 psi/138 bar

Guaranteed Sound Power Level 101 dBA

Measured Sound Power Level 99 dBA

Vibration Level..... N/A

POWER UNITS, TRACHORSE & GAS/FUEL DRIVEN EQUIPMENT: A1. Federal Emission Component Compliance 40CFR part 1060.120 Stanley warrants all fuel system emission components for 2 years from the date of original purchase provided there has been no abuse, neglect, modifications, or improper maintenance.

Components covered. The emission-related warranty covers all components whose failure would increase the evaporative emissions. Your emission-related warranty does not cover components whose failure would not increase evaporative emissions. Coverage under this warranty extends only to the following parts; fuel tank, fuel cap, fuel hose and vapor hose from the fuel tank to the engine and any connectors that are apart of the fuel system.

The equipment is designed, built, and equipped so it conforms at the time of sale to the ultimate purchaser and each subsequent purchaser and is in compliance with 40 C.F.R. 1060.120 standards. The equipment is free from defects in materials and workmanship that may keep it from meeting these requirements.

GT18B01 & B02 PARTS ILLUSTRATION

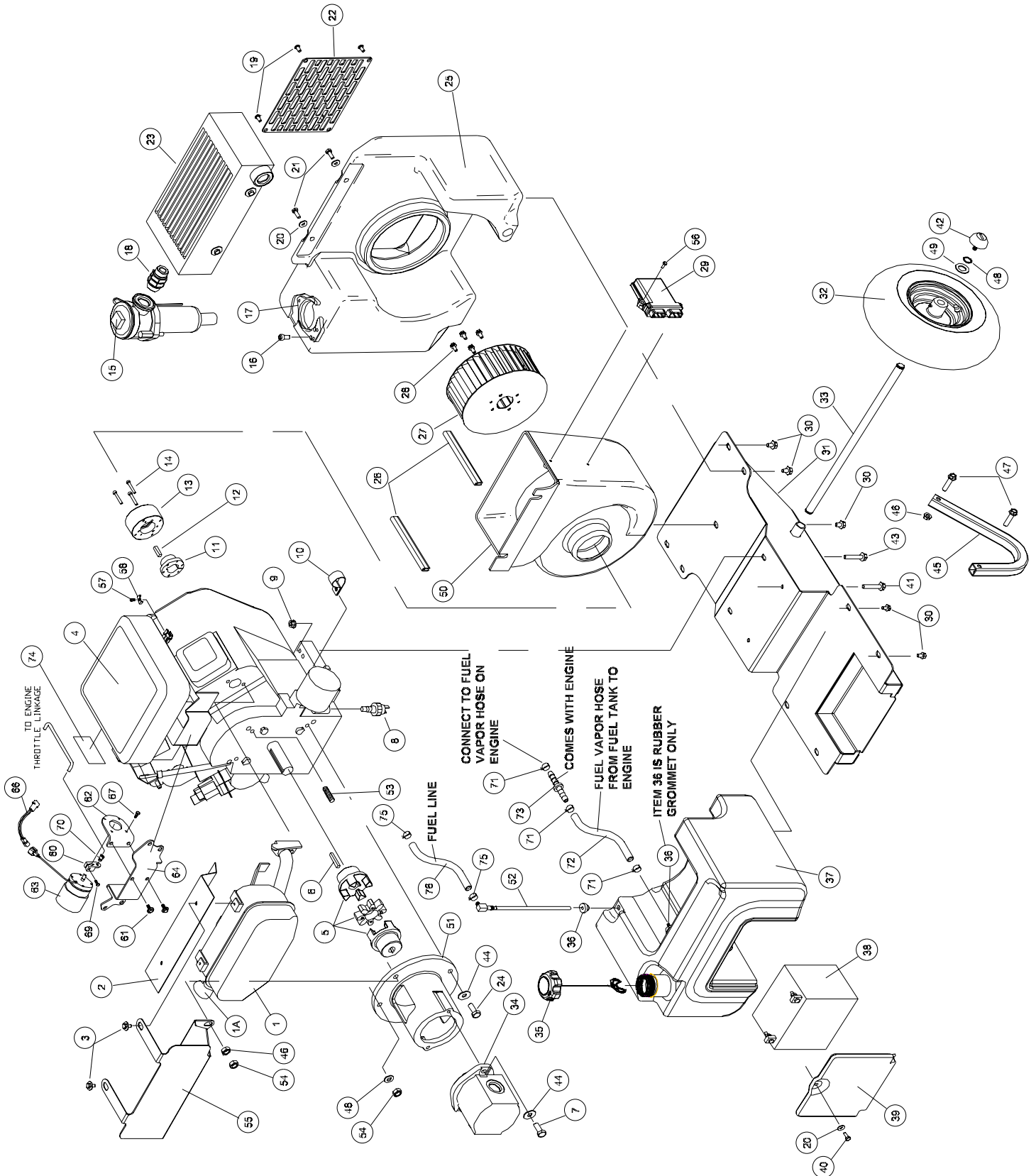

GT18B01 & B02 PARTS LIST

Item No.	Part No.	Qty	Description
1	36150	1	Muffler
1A	65456	1	Spark Arrester
2	36151	1	Heat Shield
3	36152	2	Screw, Hex Washer
4	59007	1	Briggs Engine (Includes Items 60 thru 70)
5	56656	1	Coupling
6	07819	1	Square Key
7	07860	2	Capscrew, 3/8-16 x 1-1/4
8	31765	1	Pressure Switch
9	12787	4	Flange Nut
10	24287	1	Clamp
11	59076	1	Bushing
12	20990	1	Key
13	59103	1	Blower Hub
14	00111	3	Capscrew
15	40080	1	Filter Assy
16	43687	1	Capscrew
17	64937	1	Grip Plate
18	51292	1	Std Thread Union
19	17821	4	Button Head HS
20	60945	3	Washer, 1/4 in. ID
21	15476	2	Capscrew, 1/2 -20 UNC
22	59080	1	Front Grille
23	59091	1	Cooler
24	07860	2	Capscrew, 3/8
25	59077	1	Hydraulic Tank
26	62296	2	Weather Strip
27	62303	1	Blower Wheel
28	59074	4	Hex Flange Bolt, 1/4 -20
29	72315	1	Engine Controller GT18B01 ONLY
	72316	1	Engine Controller GT18B02 ONLY
30	40433	9	Hex Flange Bolt 5/16-18 x 1/2
31	58897	1	Frame Base Weldment
32	58918	2	Wheel & Tire
33	58917	1	Axle
34	04134	1	Pump, Single
35	71794	1	Fuel Cap (Important see note on page 22 before ordering)

Item No.	Part No.	Qty	Description
36	60920	1	Grommet
37	73050	1	Fuel Tank (Important see note on page 22 before ordering)
38	04303	1	Battery
39	60921	1	Battery Cover
40	15476	1	Capscrew, 1/4-20 x 3/4
41	65068	1	Hex Flange Bolt
42	21714	2	Handle Bumper
43	58942	3	Hex Flange Bolt, 5/16 x 1-3/4
44	01459	4	Lockwasher, 3/8
45	58975	2	Foot
46	18893	4	Flang Nut, 3/8-16
47	58976	4	Hex Flange Bolt, 3/8-16
48	31240	2	Retaining Ring
49	21318	2	Washer, 3/4
50	59083	1	Blower Housing
51	56655	1	Pump Mount
52	60919	1	Fuel Elbow
53	62385	2	Stud
54	371503	1	Nut
55	62324	1	Heat Shield
56	62292	2	Hex Washer Head Screws
57	64991	1	Screw
58	56709	1	Cable Clamp
59	65042	1	Rectifier Wire
60	69374	1	Throttle Lever
61	59074	2	Hex Flange Bolt
62	68675	1	Angle Bracket Weldment
63	68560	1	Rottary Actuator
64	68676	1	Actuator Bracket
66	69401	1	Wire Assembly
67	69281	4	Hex Socket Head Capscrew
69	69282	1	Hex Socket Head Capscrew
70	62181	1	Link Retainer
71	72451	3	Spring Hose Clamp
72	72571	1	Fuel Vapor Hose
73	72568	1	Barb
75	72317	2	Spring Hose Clamp
76	62289	1	Hose (Fuel)

FUEL TANK & CAP

NOTE: When ordering a fuel tank (item 37) or fuel tank cap (item 35) **DO NOT MIX OLD STYLE TANK AND CAP WITH NEW STYLE TANK AND CAP.**

If you have a power unit and it was purchased prior to 2011 and need to replace the fuel tank or fuel tank cap, you must purchase the same tank and cap that came with your unit.

For example if you have a power unit prior to 2011 do not purchase a new style fuel tank, your engine will not be equipped with a fuel vapor fitting.

The old style fuel cap is a vented cap, while the new style fuel cap is not a vented cap and venting is achieved thru the vapor line.

The old style fuel tank has only one fuel line coming from the tank to the engine. The new style fuel tank has two lines coming from the fuel tank to the engine, one is the fuel line and the other is a fuel vapor line.

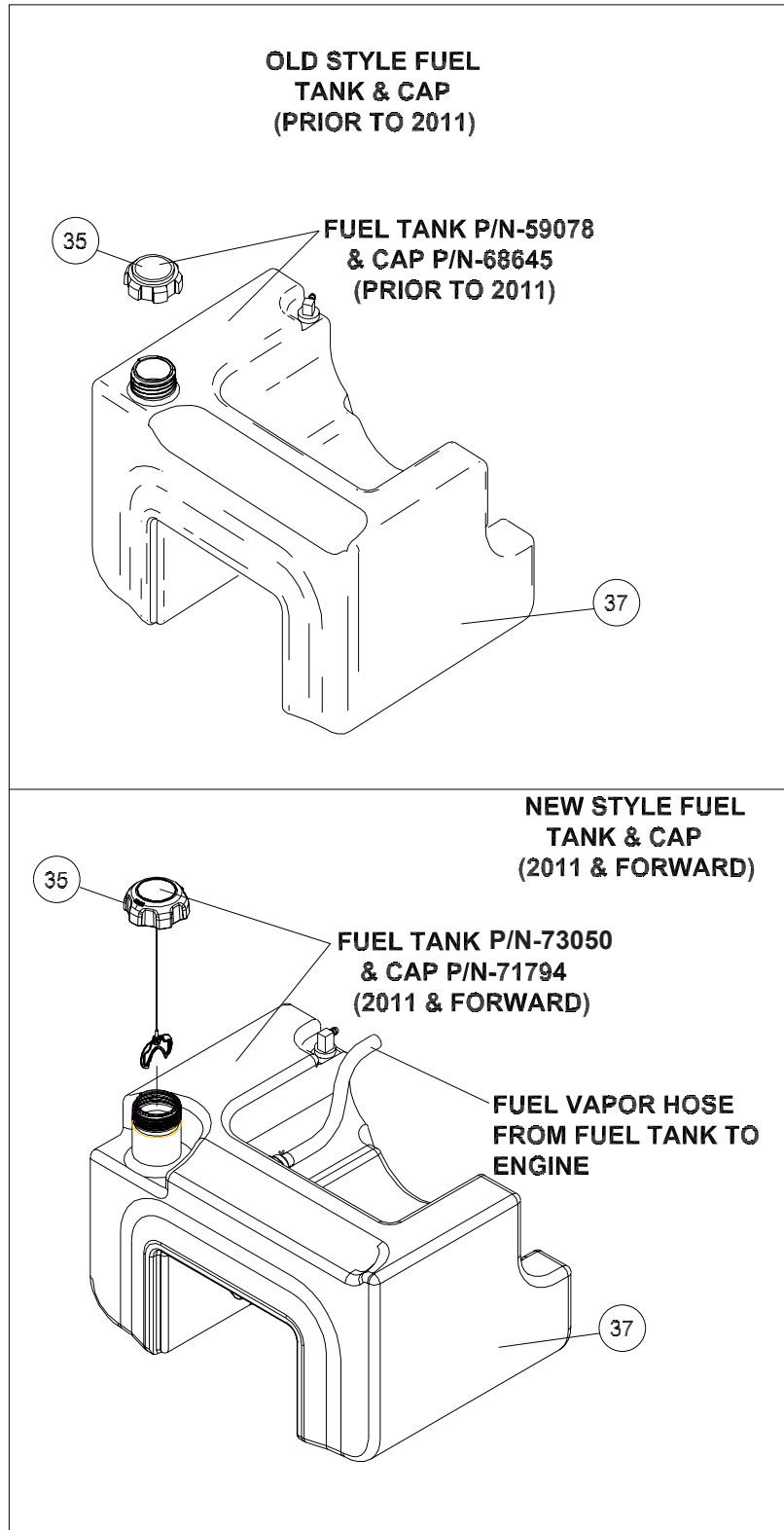

FRAME PARTS

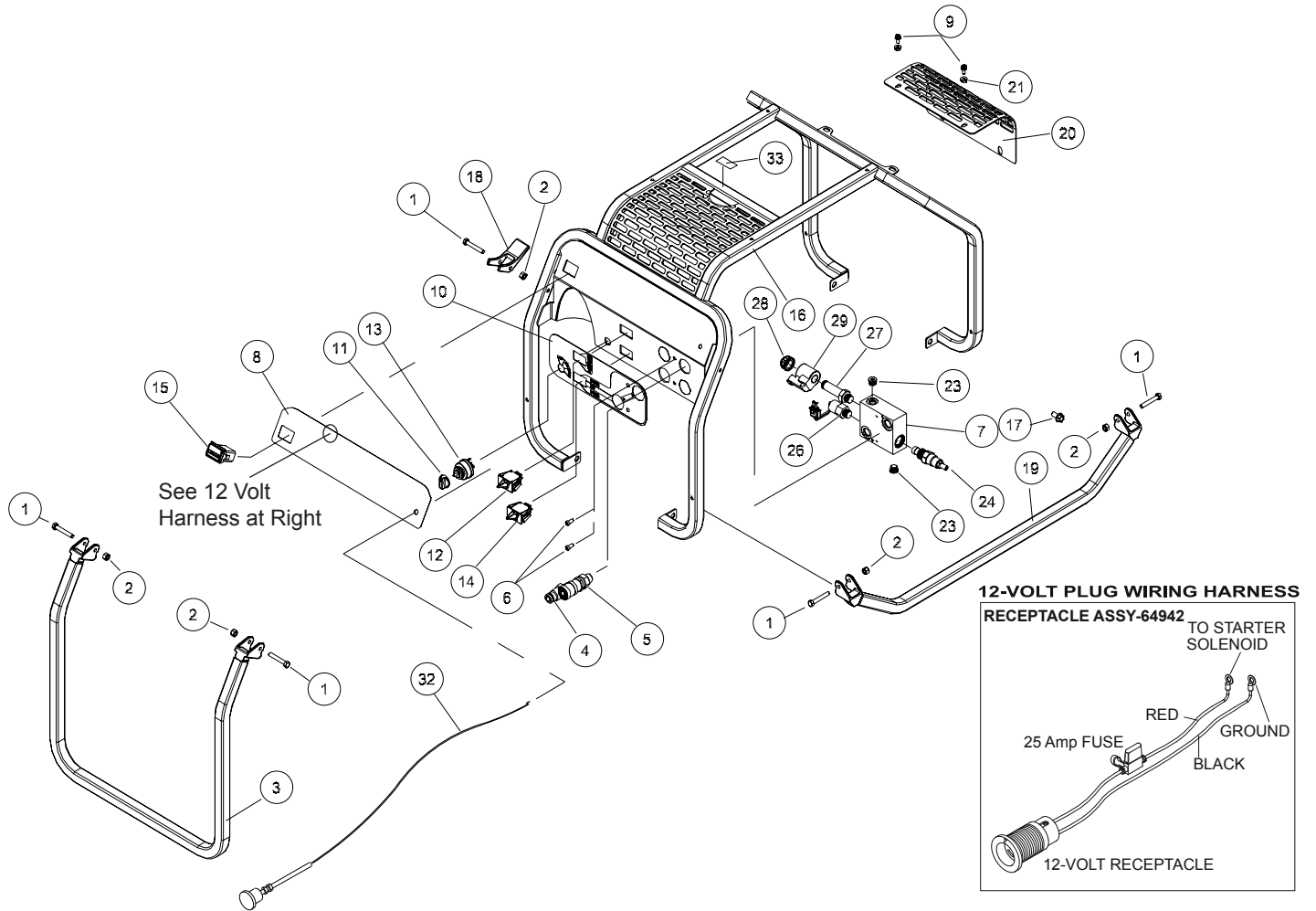

Item No.	Part No.	Qty	Description
1	370502	7	Capscrew, 5/16 in.-18 UNC
2	03906	7	Nylock Nut, 5/16 in. -18 UNC
3	62267	1	Handle, Rear Lift
4	58857	1	Coupler, Male 3/8 in., -8 SAE
5	58856	1	Coupler, Female 3/8 in., -8 SAE
6	60962	2	Capscrew, 1/4 in. -20
7	59130	1	Manifold Assy, Single Circuit (includes items 23 thru 29)
8	62302	1	Dash Decal
9	59074	6	Hex Flange Bolt, 1/4 in. -20
10	62300	1	Decal, Single Circuit
11	67899	1	Rotary Switch (part of item 13)
12	60955	1	2-Way Switch
13	67899	1	Rotary Switch (part of item 11)
14	60956	1	3-Way Switch
15	60946	1	Hour Meter
16	62269	1	Frame Weldment

Item No.	Part No.	Qty	Description
17	23530	2	Hex Flange Bolt, 3/8 in. -16
18	58916	1	Handle Lock
19	62268	2	Lift Handle
20	59079	1	Cooler Guard
21	59095	2	Flange Nut, 1/4 in. -20
22			No Item
23	08104	2	Hollow Hex Plug 6 SAE
24	59131	1	Relief Valve
25	--	-	No Item
26	59128	1	Pressure Switch Assy
27	60959	1	Directional Valve
28	---	1	Cap (Included with Item 27)
29	60958	1	Coil
30	28322	1	CE Decal
31	66653	1	Sound Power Sticker
32	62298	1	Choke Cable Assy
33	73306	1	Lift Point Decal

HOSES, FITTINGS & CLAMPS

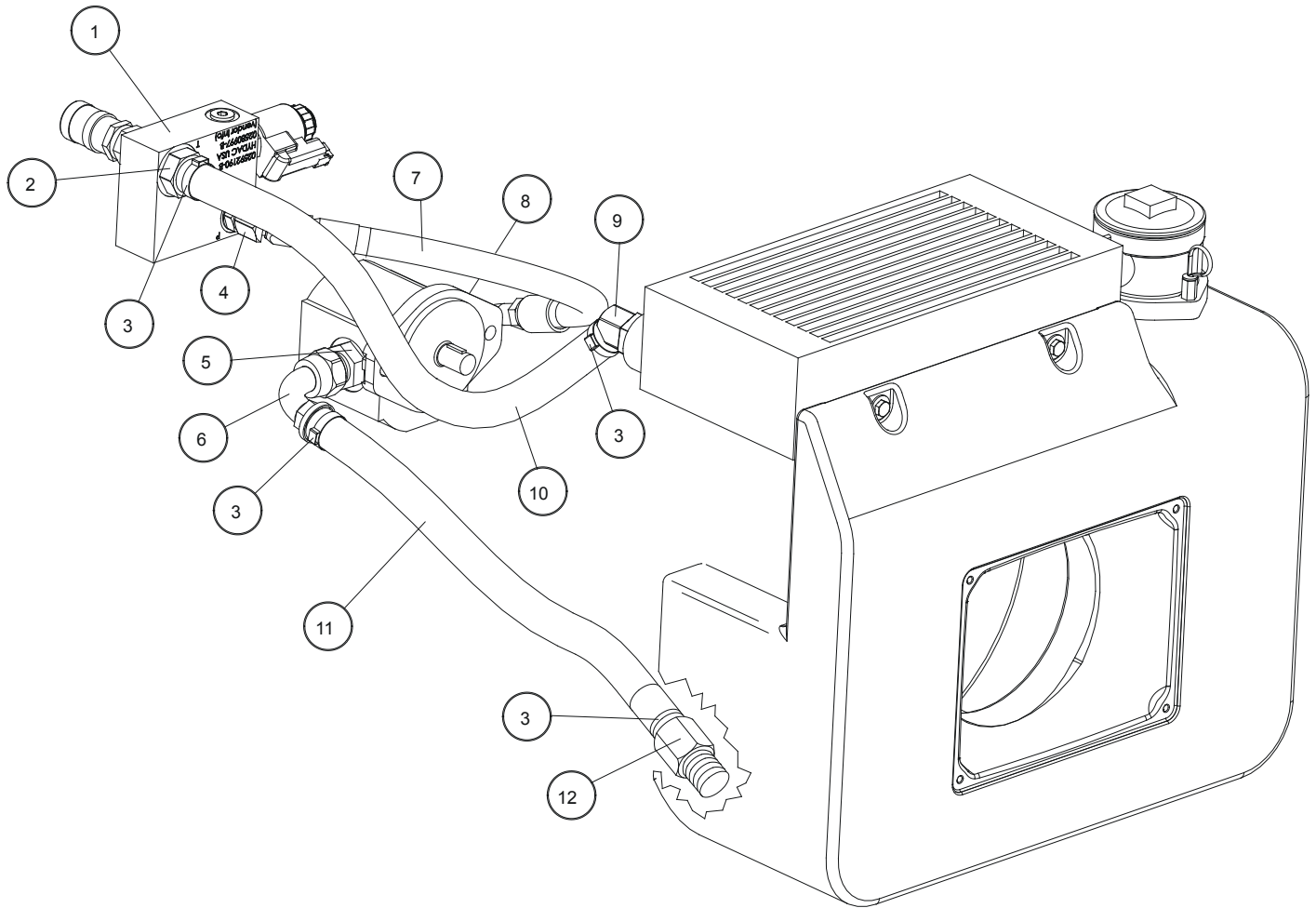

Item No.	Part No.	Qty	Description
1	59130	1	Manifold Assy, Single Circuit
2	59104	1	Hose Barb, 3/4 in. Hose x 3/4 in. Pipe
3	62199	4	Hose Clamp
4	350000	1	Elbow, 45° Straight Thread
5	02773	1	Adapter
6	58569	1	Elbow, 90°
7	58943	1	Hose
8	350104	1	Connector, Straight Thread
9	40364	1	Elbow, 45°
10	59088	1	Hose
11	59089	1	Hose
12	59105	1	Hose Barb, 3/4 in. Hose x 3/4 in. Pipe

MAIN WIRING HARNESS

HARNESS PART NUMBER 65147

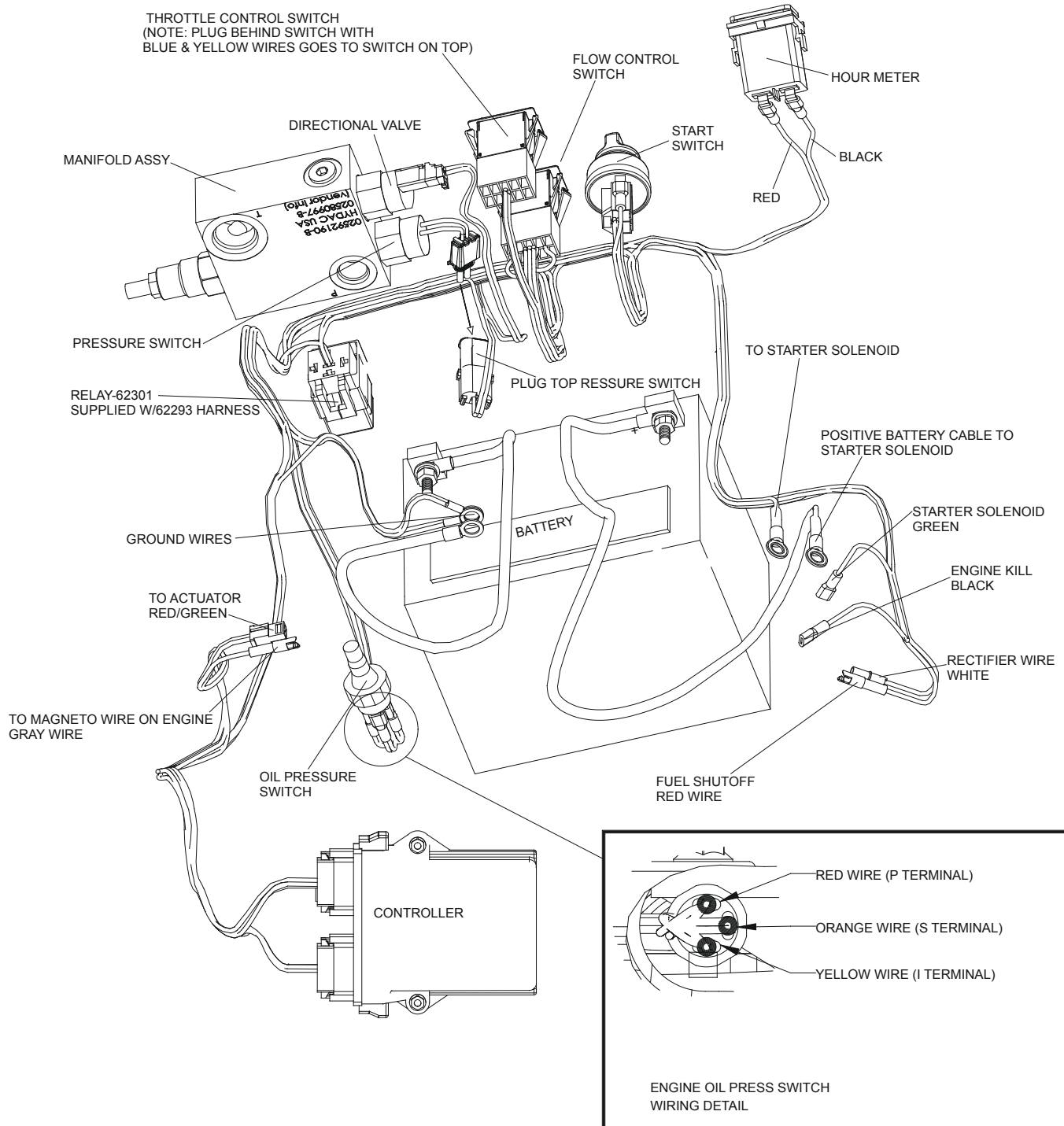

STANLEY®

Stanley Hydraulic Tools
3810 SE Naef Road
Milwaukie, Oregon 97267-5698 USA
(503) 659-5660 / Fax (503) 652-1780
www.stanleyhydraulics.com