

STANLEY®

HD01 HYDRAULIC HAMMER DRILL



USER MANUAL Safety, Operation and Maintenance



© 2017 STANLEY Black & Decker, Inc.
New Britain, CT 06053
U.S.A.
72659 12/2023 Ver. 16

DECLARATION OF CONFORMITY

DECLARATION OF CONFORMITY
ÜBEREINSTIMMUNGS-ERKLÄRUNG
DECLARATION DE CONFORMITE CEE
DECLARACION DE CONFORMIDAD
DICHIARAZIONE DI CONFORMITA

STANLEY
Hydraulic Tools
CE

I, the undersigned:
Ich, der Unterzeichnende:
Je soussigné:
El abajo firmante:
Io sottoscritto:

Shravan Kumar Gunishetty

Surname and First names/Familienname und Vornamen/Nom et prénom/Nombre y apellido/Cognome e nome

hereby declare that the equipment specified hereunder:
bestätige hiermit, daß erklaren Produkt genannten Werk oder Gerät:
déclare que l'équipement visé ci-dessous:
Por la presente declaro que el equipo se especifica a continuación:
Dichiaro che le apparecchiature specificate di seguito:

- Category: **Hammer Drill, Hydraulic**
Kategorie:
Catégorie:
Categoria:
Categoria:
- Make/Marke/Marque/Marca/Marca **Stanley**
- Type/Typ/Type/Tipo/Tipo: **HD0153101, HD0153101D**
- Serial number of equipment:
Seriennummer des Geräts:
Numéro de série de l'équipement:
Numero de serie del equipo:
Matricola dell'attrezzatura: **All**

Has been manufactured in conformity with
Wurde hergestellt in Übereinstimmung mit
Est fabriqué conformément
Ha sido fabricado de acuerdo con
E' stata costruita in conformità con

Directive/Standards Richtlinie/Standards Directives/Normes Directriz/Los Normas Direttiva/Norme	No. Nr Numéro No n.	Approved body Prüfung durch Organisme agréé Aprobado Collaudato
ISO	12100:2010	Self
ISO	4413:2010	Self
ISO	3744:2010	Self
ISO	11148-5:2011	Self
Machinery Directive	28927-10:2011	Self
EN ISO	13732-1:2008	Self
	2006/42/EC:2006	Self

- Special Provisions: **None** Measurements: Guaranteed Sound Power Level 103 dBA
Spezielle Bestimmungen: Sound Pressure Level at Operator 92.3 dBA
Dispositions particulières:
Provisiones especiales: Combined Vibration Average 3 Axis -15.8 m/s²
Disposizioni speciali:

- Representative in the Union: **Patrick Vervier, Stanley Dubuis 17-19, rue Jules Berthonneau-BP 3406 41034 Blois Cedex, France.**
Vertreter in der Union/Représentant dans l'union/Representante en la Union/Rappresentante presso l'Unione

Done at/Ort/Fait à/Dado en/Fatto a Stanley Hydraulic Tools, Milwaukie, Oregon USA Date/Datum/le/Fecha/Data 1-24-2021

Signature/Unterschrift/Signature/Firma/Firma

Position/Position/Fonction/Cargo/Posizione Shravan Kumar Gunishetty Quality Engineer

TABLE OF CONTENTS

SAFETY SYMBOLS.....	4
SAFETY PRECAUTIONS	5
TOOL STICKERS & TAGS	6
HOSE TYPES	7
HOSE RECOMMENDATIONS.....	8
HTMA / EHTMA REQUIREMENTS	9
OPERATION	10
LOCKOUT KIT OC/CC	14
TROUBLESHOOTING	15
ACCESSORIES.....	17
SERVICE PARTS.....	17
SPECIFICATIONS	17
HD01 PARTS ILLUSTRATION.....	18
HD01 PARTS LIST.....	19

IMPORTANT

To fill out a product warranty validation form, and for information on your warranty, visit www.stanleyinfrastructure.com and select the Company tab > Warranty.

Note: The warranty validation record must be submitted to validate the warranty.

SERVICING: This manual contains safety, operation and routine maintenance instructions. STANLEY Infrastructure recommends that servicing of hydraulic tools, other than routine maintenance, must be performed by an authorized and certified dealer. Please read the following warning.

WARNING

SERIOUS INJURY OR DEATH COULD RESULT FROM THE IMPROPER REPAIR OR SERVICE OF THIS TOOL.

REPAIRS AND / OR SERVICE TO THIS TOOL MUST ONLY BE DONE BY AN AUTHORIZED AND CERTIFIED DEALER.

For the nearest certified dealer, call STANLEY Infrastructure at (503) 659-5660 and ask for a Customer Service Representative.

SAFETY SYMBOLS

Safety symbols and signal words, as shown below, are used to emphasize all operator, maintenance and repair actions which, if not strictly followed, could result in a life-threatening situation, bodily injury or damage to equipment.



This is the safety alert symbol. It is used to alert you to potential personal injury hazards. Obey all safety messages that follow this symbol to avoid possible injury or death.



This safety alert and signal word indicates an imminently hazardous situation which, if not avoided, will result in death or serious injury.



This safety alert and signal word indicates a potentially hazardous situation which, if not avoided, could result in death or serious injury.



This safety alert and signal word indicates a potentially hazardous situation which, if not avoided, could result in death or serious injury.



This signal word indicates a potentially hazardous situation which, if not avoided, may result in property damage.



This signal word indicates a situation which, if not avoided, will result in damage to the equipment.



This signal word indicates a situation which, if not avoided, may result in damage to the equipment.

Always observe safety symbols. They are included for your safety and for the protection of the tool.

LOCAL SAFETY REGULATIONS

Enter any local safety regulations here. Keep these instructions in an area accessible to the operator and maintenance personnel.

Tool operators and maintenance personnel must comply with the safety precautions given in this manual and on the stickers and tags attached to the tool and hose.

These precautions are given for your safety. Review them carefully before operating the tool and before performing general maintenance or repairs.

Supervising personnel should develop additional precautions relating to the specific work area and local safety regulations. Place the added precautions in the space provided.

The HD01 Hydraulic Hammer Drill will provide safe and dependable service if operated in accordance with the instructions given in this manual. Read and understand this manual and any stickers and tags attached to the tool and hose before operation. Failure to do so could result in personal injury or equipment damage.



SAFETY PRECAUTIONS

- The operator must start in a work area without bystanders. Flying debris can cause serious injury.
- Do not operate the tool unless thoroughly trained or under the supervision of an instructor. Establish a training program for all operators to ensure safe operation.
- Always wear personal protective equipment. Always wear eye protection. Protective equipment such as dust mask, non-skid safety shoes, hard hat or hearing protection used for appropriate conditions will reduce personal injuries.
- Remove any adjusting key or wrench before turning the tool on. A wrench or key left attached to a rotating part of the tool may result in personal injury.
- The operator must be familiar with all prohibited work areas such as excessive slopes and dangerous terrain conditions.
- Do not change accessories, make adjustments, inspect, clean or replace any part(s) if the hydraulic power source is connected. Accidental engagement of the tool can cause serious injury.
- Always connect hoses to the tool hose couplers before energizing the hydraulic power source. Be sure all hose connections are tight and are in good condition.
- Do not operate the tool at oil temperatures above 140 °F/60 °C. High temperatures can result in operator discomfort.
- Do not operate a damaged, improperly adjusted or incompletely assembled hammer drill.
- Never wear loose clothing that can get entangled in the working parts of the tool.
- Keep all parts of your body away from the drill and maintain proper footing and balance at all times.
- When working near electrical conductors, always assume that all conductors are energized and that insulation, clothing and hoses can conduct electricity. Stay a safe distance away from electrical conductors.
- Do not operate tool in explosive atmospheres, such as in the presence of flammable liquids, gases or dust. Power tools create sparks which may ignite the dust or fumes.
- Keep cutting tools sharp and clean. Properly maintained cutting tools with sharp cutting edges are less likely to bind and are easier to control.
- Keep a firm grip on the tool at all times. Do not attempt to operate the tool without holding it with both hands. It is recommended that the side handle be used at all times. Operating this tool with one hand will result in loss of control. Tighten the side handle securely before use.
- Never lay the tool down until the bit has come to a complete stop. Moving bits could cause injury.
- Wear gloves when operating tool or changing bits. Accessible metal parts on the tool and bits may get extremely hot during operation.
- If the hydraulic power supply has been interrupted, place the hammer drill in the OFF position before restarting the hydraulic power supply.
- To avoid personal injury or equipment damage, all tool repair, maintenance and service must only be performed by authorized and properly trained personnel.
- **WARNING:** Some dust created by power sanding, sawing, grinding, drilling, and other construction activities contains chemicals known to the State of California to cause cancer, birth defects or other reproductive harm. Some examples of these chemicals are:
 - Lead from lead-based paints,
 - crystalline silica from bricks and cement and other masonry products, and
 - arsenic and chromium from chemically-treated lumber.

Your risk from these exposures varies, depending on how often you do this type of work. To reduce your exposure to these chemicals: work in a well ventilated area, and work with approved safety equipment, such as those dust masks that are specially designed to filter out microscopic particles.

Protect yourself and those around you. Research and understand the materials you are cutting. Follow correct safety procedures and comply with all applicable national, state or provisional health and safety regulations relating to them, including, if appropriate arranging for the safe disposal of the materials by a qualified person.

TOOL STICKERS & TAGS

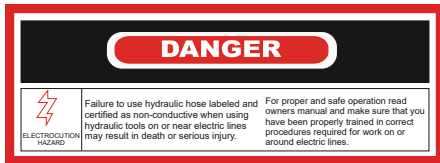

17160
Electrical Danger Decal



11354
OC/CC Decal

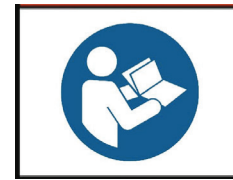

88348
Manual Decal

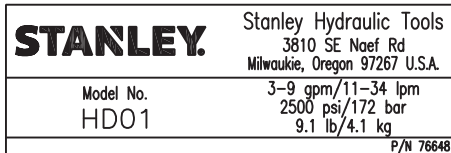

76648
HD01 Name Tag

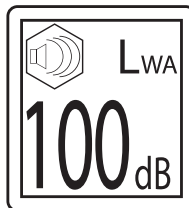

81435
Sound Power Level Decal

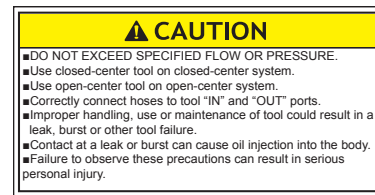

09612
General Caution Sticker



88344
Importer Decal



11207
Circuit D Decal



11206
Circuit C Decal



28323
CE Decal

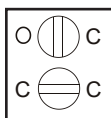

17162
OC/CC Decal

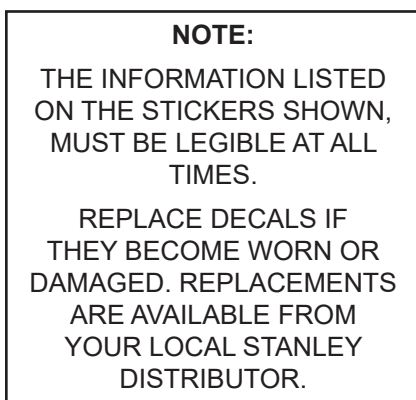

The safety tag (P/N 88346) at right is attached to the tool when shipped from the factory. Read and understand the safety instructions listed on this tag before removal. We suggest you retain this tag and attach it to the tool when not in use.

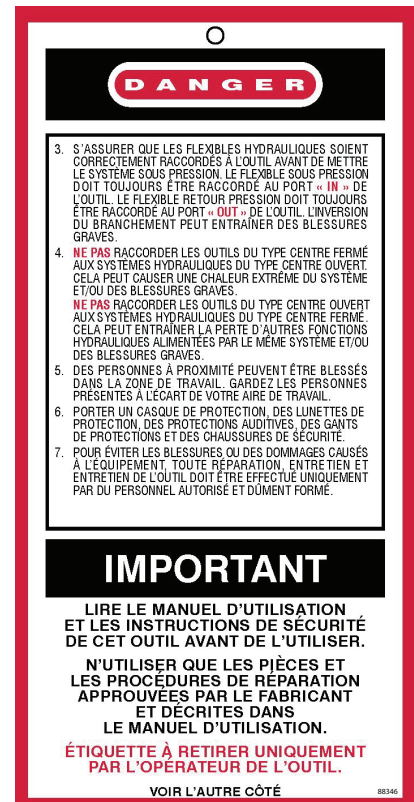
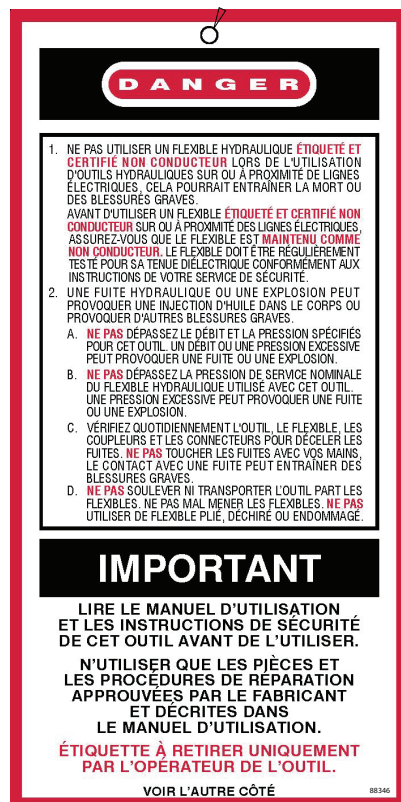

SAFETY TAG P/N 88346 (Shown smaller than actual size)

HOSE TYPES

The rated working pressure of the hydraulic hose must be equal to or higher than the relief valve setting on the hydraulic system. There are three types of hydraulic hose that meet this requirement and are authorized for use with STANLEY hydraulic tools. They are:

Certified non-conductive — constructed of thermoplastic or synthetic rubber inner tube, synthetic fiber braid reinforcement, and weather resistant thermoplastic or synthetic rubber cover. *Hose labeled **certified non-conductive** is the only hose authorized for use near electrical conductors.*

Wire-braided (conductive) — constructed of synthetic rubber inner tube, single or double wire braid reinforcement, and weather resistant synthetic rubber cover. *This hose is **conductive** and must never be used near electrical conductors.*

Fabric-braided (not certified or labeled non-conductive) — constructed of thermoplastic or synthetic rubber inner tube, synthetic fiber braid reinforcement, and weather resistant thermoplastic or synthetic rubber cover. *This hose is **not certified non-conductive** and must never be used near electrical conductors.*

HOSE SAFETY TAGS

To help ensure your safety, the following DANGER tags are attached to all hose purchased from STANLEY. DO NOT REMOVE THESE TAGS.

If the information on a tag is illegible because of wear or damage, replace the tag immediately. A new tag may be obtained from your STANLEY Distributor.

THE TAG SHOWN BELOW IS ATTACHED TO “CERTIFIED NON-CONDUCTIVE” HOSE

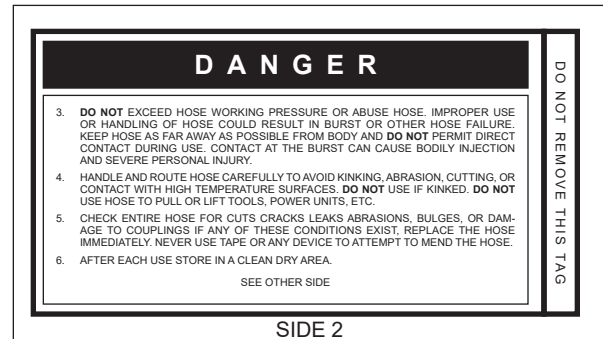
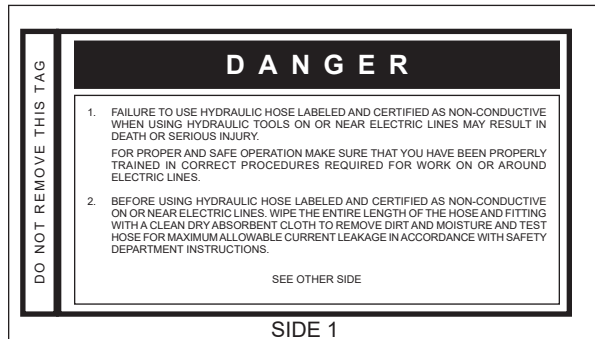

(Shown smaller than actual size)

THE TAG SHOWN BELOW IS ATTACHED TO “CONDUCTIVE” HOSE.

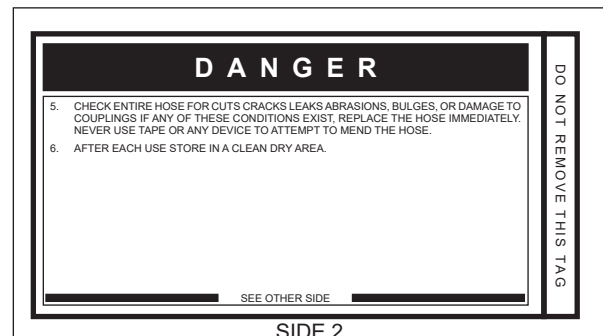
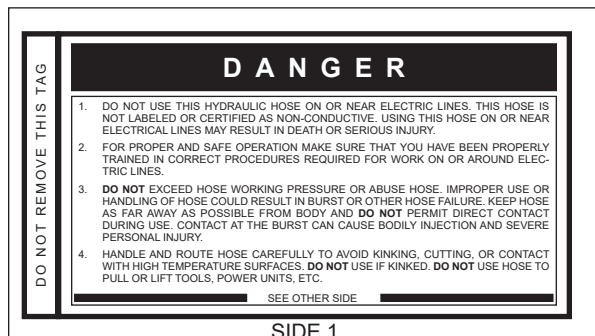

(Shown smaller than actual size)

HOSE RECOMMENDATIONS

Tool to Hydraulic Circuit Hose Recommendations

The chart to the right shows recommended minimum hose diameters for various hose lengths based on gallons per minute (GPM)/liters per minute (LPM). These recommendations are intended to keep return line pressure (back pressure) to a minimum acceptable level to ensure maximum tool performance.

This chart is intended to be used for hydraulic tool applications only based on STANLEY tool operating requirements and should not be used for any other applications.

All hydraulic hose must have at least a rated minimum working pressure equal to the maximum hydraulic system relief valve setting.

All hydraulic hose must meet or exceed specifications as set forth by SAE J517.

Oil Flow		Hose Lengths		Inside Diameter		USE (Press/Return)	Min. Working Pressure	
GPM	LPM	FEET	METERS	INCH	MM		PSI	BAR
Certified Non-Conductive Hose - Fiber Braid - for Utility Bucket Trucks								
4-9	15-34	up to 10	up to 3	3/8	10	Both	2250	155
Conductive Hose - Wire Braid or Fiber Braid - DO NOT USE NEAR ELECTRICAL CONDUCTORS								
4-6	15-23	up to 25	up to 7.5	3/8	10	Both	2500	175
4-6	15-23	26-100	7.5-30	1/2	13	Both	2500	175
5-10.5	19-40	up to 50	up to 15	1/2	13	Both	2500	175
5-10.5	19-40	51-100	15-30	5/8	16	Both	2500	175
5-10.5	19-40	100-300	30-90	5/8	16	Pressure	2500	175
10-13	38-49	up to 50	up to 15	3/4	19	Return	2500	175
10-13	38-49	51-100	15-30	5/8	16	Both	2500	175
10-13	38-49	100-200	30-60	3/4	19	Pressure	2500	175
13-16	49-60	up to 25	up to 8	1	25.4	Return	2500	175
13-16	49-60	26-100	8-30	5/8	16	Pressure	2500	175
				3/4	19	Return	2500	175
				3/4	19	Pressure	2500	175
				1	25.4	Return	2500	175

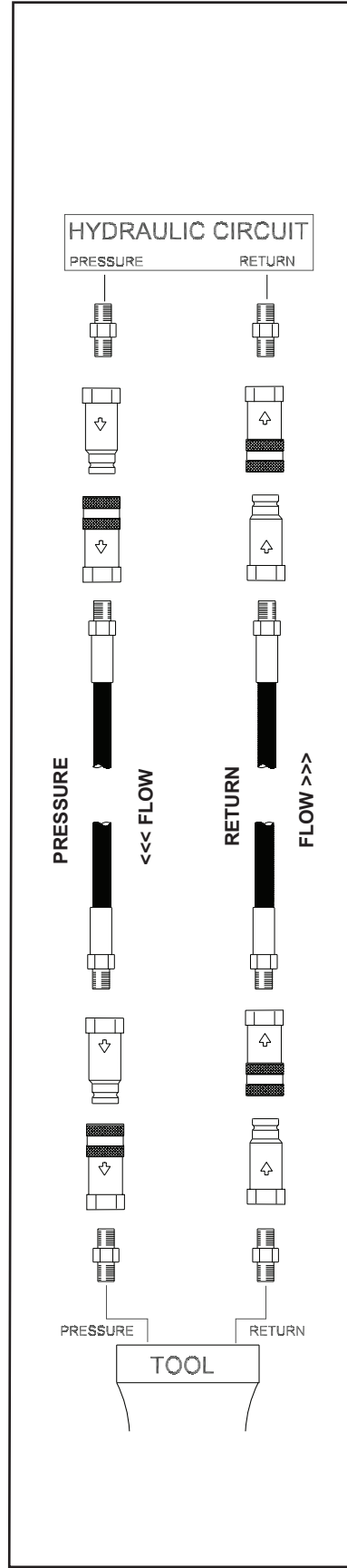

Figure 1. Typical Hose Connections





HTMA / EHTMA REQUIREMENTS

HTMA / EHTMA REQUIREMENTS

TOOL TYPE

HTMA HYDRAULIC SYSTEM REQUIREMENTS	TYPE I	TYPE II	TYPE RR	TYPE III
Flow range	4-6 GPM (15-23 LPM)	7-9 GPM (26-34 LPM)	9-10.5 GPM (34-40 LPM)	11-13 GPM (42-49 LPM)
Nominal operating pressure (At the power supply outlet)	1500 psi (103 bar)	1500 psi (103 bar)	1500 psi (103 bar)	1500 psi (103 bar)
System relief valve setting (At the power supply outlet)	2100-2250 psi (145-155 bar)	2100-2250 psi (145-155 bar)	2200-2300 psi (152-159 bar)	2100-2250 psi (145-155 bar)
Maximum back pressure (At tool end of the return hose)	250 psi (17 bar)	250 psi (17 bar)	250 psi (17 bar)	250 psi (17 bar)
Measured at a max fluid viscosity of: (At minimum operating temperature)	400 ssu* (82 centistokes)	400 ssu* (82 centistokes)	400 ssu* (82 centistokes)	400 ssu* (82 centistokes)
Temperature: Sufficient heat rejection capacity to limit maximum fluid temperature to: (At maximum expected ambient temperature)	140° F (60° C)	140° F (60° C)	140° F (60° C)	140° F (60° C)
Minimum cooling capacity at a temperature difference of between ambient and fluid temps	3 hp (2.24 kW) 40° F (22° C)	5 hp (3.73 kW) 40° F (22° C)	6 hp (5.22 kW) 40° F (22° C)	7 hp (4.47 kW) 40° F (22° C)
Note: Do not operate the tool at oil temperatures above 140° F (60° C). Operation at higher temperatures can cause operator discomfort at the tool.				
Filter minimum full-flow filtration Sized for flow of at least: (For cold temp startup and maximum dirt-holding capacity)	25 microns 30 GPM (114 LPM)	25 microns 30 GPM (114 LPM)	25 microns 30 GPM (114 LPM)	25 microns 30 GPM (114 LPM)
Hydraulic fluid, petroleum based (premium grade, anti- wear, non-conductive) Viscosity (at minimum and maximum operating temps)	100-400 ssu (20-82 centistokes)	100-400 ssu (20-82 centistokes)	100-400 ssu (20-82 centistokes)	100-400 ssu (20-82 centistokes)
Note: When choosing hydraulic fluid, the expected oil temperature extremes that will be experienced in service determine the most suitable temperature viscosity characteristics. Hydraulic fluids with a viscosity index over 140 will meet the requirements over a wide range of operating temperatures.				
*SSU = Saybolt Seconds Universal				

CLASSIFICATION

EHTMA HYDRAULIC SYSTEM REQUIREMENTS					
Flow range	3.5-4.3 GPM (13.5-16.5 LPM)	4.7-5.8 GPM (18-22 LPM)	7.1-8.7 GPM (27-33 LPM)	9.5-11.6 GPM (36-44 LPM)	11.8-14.5 GPM (45-55 LPM)
Nominal operating pressure (At the power supply outlet)	1870 psi (129 bar)	1500 psi (103 bar)	1500 psi (103 bar)	1500 psi (103 bar)	1500 psi (103 bar)
System relief valve setting (At the power supply outlet)	2495 psi (172 bar)	2000 psi (138 bar)	2000 psi (138 bar)	2000 psi (138 bar)	2000 psi (138 bar)

Note: These are general hydraulic system requirements. See tool specification page for tool specific requirements.

OPERATION

PRE-OPERATION PROCEDURES

CHECK POWER SOURCE

1. Using a calibrated flowmeter and pressure gauge, check that the hydraulic power source develops a flow of 4–9 GPM/15–34 LPM at 950–2000 psi/65–140 bar.
2. Make certain that the hydraulic power source is equipped with a relief valve set to open at 2100–2250 psi/145–155 bar.
3. Check that the hydraulic circuit matches the tool for open-center (OC) or closed-center (CC) operation.

CHECK THE TOOL

1. Make certain all tool accessories are correctly installed. Failure to install tool accessories properly can result in damage to the tool or personal injury.
2. There should be no signs of leaks.
3. The tool should be clean and dry with all fittings and fasteners tight.

CONNECT HOSES

1. Wipe all hose couplers with a clean lint-free cloth before making connections.
2. Connect the hoses from the hydraulic power source to the tool fittings or quick disconnects. Connect the return hose first and disconnect it last to eliminate or reduce trapped pressure for easier quick connect fitting attachment.

Note: If uncoupled hoses are left in the sun, pressure increase within the hoses can make them difficult to connect. Whenever possible, connect the free ends of hoses together.

3. Observe the flow indicators stamped on the hose couplers to ensure that the flow is in the proper direction. The female coupler on the tool's **IN** port is the inlet coupler. See illustration in back of this manual for tool port identification.
4. Squeeze the drill trigger momentarily. If the drill does not operate, the hoses might be reversed. Verify correct connection of the hoses before continuing.

DETERMINE TOOL MODEL

Open-center or Closed-center Models

Closed-center models have a closed-center decal on the bottom of the handle.

If you are in doubt about the type, test the tool by connecting it to an open-center circuit with the trigger released. If pressure rises more in the circuit with the trigger released than when the trigger is pulled, the tool

is closed-center.

OPEN-CENTER/CLOSED-CENTER SELECTABLE MODELS

The open-center/closed-center selectable model has a decal on the trigger strut to show which position to select.

IMPORTANT

Failure to set this spool correctly can cause a mismatch with the hydraulic circuit. This can result in rapid tool heating, seal failure and poor tool performance.

Note: All models have a knurled knob on the spool. This knob cannot be rotated on single-circuit type tools.

CONTROLS

FORWARD/REVERSE

Forward/Reverse rotation is selected by the lever on the left-hand side of the tool, as shown in Figure 2.

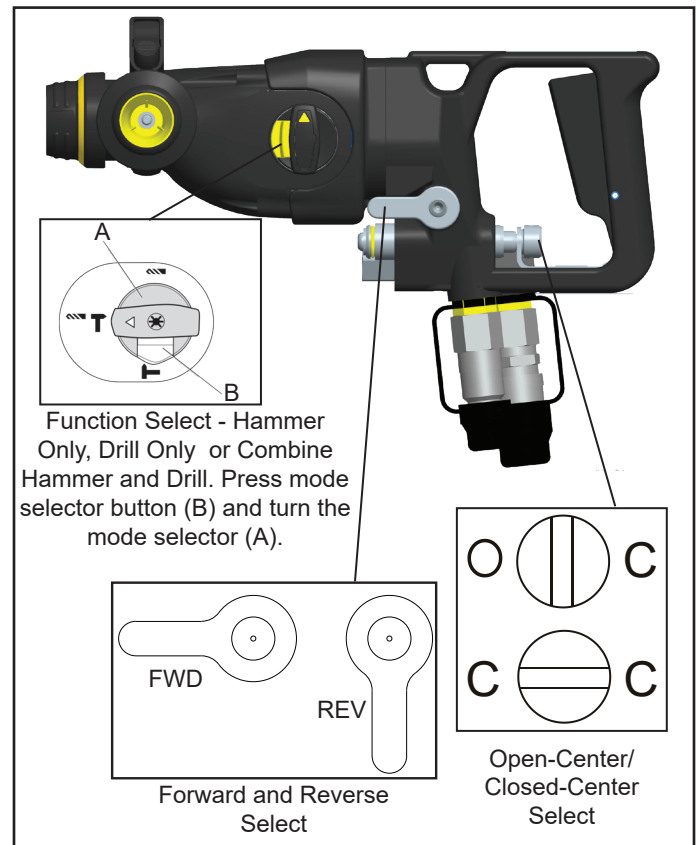

Figure 2: Operator Controls

OPERATION

MODE SELECTOR

⚠ WARNING

Do not select the operating mode when the tool is running.

IMPORTANT

The tool must come to a complete stop before activating the mode selector button or damage to the tool may result. Do not operate the tool unless the hammer drill knob is set.

To select a drill mode, press mode selector button (B) (figure 2) and turn the mode selector (A) so the yellow arrow points to the corresponding symbol.

 **Drill only mode:** Use drill-only mode for screw driving and for drilling into metal, wood and plastics.

 **Hammer only mode:** For light chiseling and demolition applications. In this mode the tool can also be used as a lever to free a jammed drill bit.

 **Hammer/Drill mode:** Use this mode for concrete and masonry drilling.

Note: When rotating the mode selector, release the safety lock and check that the mode selector switch is locked in place.

OPEN-CENTER CLOSED-CENTER OC/CC

The OC/CC selectable model has a knurled knob on the spool end holding the trigger strut and has two opposing set screws showing the circuit setting. If the set screws are horizontal (cross-wise), the setting is for closed-center circuits. If the set screws are on a vertical line, the setting is for open-center circuits. The knob can be twisted to change the setting and should be checked. A decal on the trigger strut helps remind you of the knob

positions to select.

Note: Single circuit type tools now have a knob on the spool but it cannot be rotated.

DEPTH GAUGE

Drilling depth can be set using the depth gauge mounted on the side handle (see Figure 3). To set the gauge, push down on the release button (G) on the side handle, slide the depth gauge (C) to the desired position, and release the button making sure it snaps into place. Be sure the side handle (D) is tight before operating the tool.

The spacing between lines on the depth gauge are in inches and millimeters. The depth gauge can be removed when not in use.

SIDE HANDLE

The side handle assembly, including the depth gauge, fits over the front housing of the hammer drill to assist the operator in maneuvering the tool.

To adjust the side handle to a comfortable position, twist the hand grip in a counterclockwise direction and reposition the handle assembly. Once in position, tighten the handle assembly by twisting the hand grip in

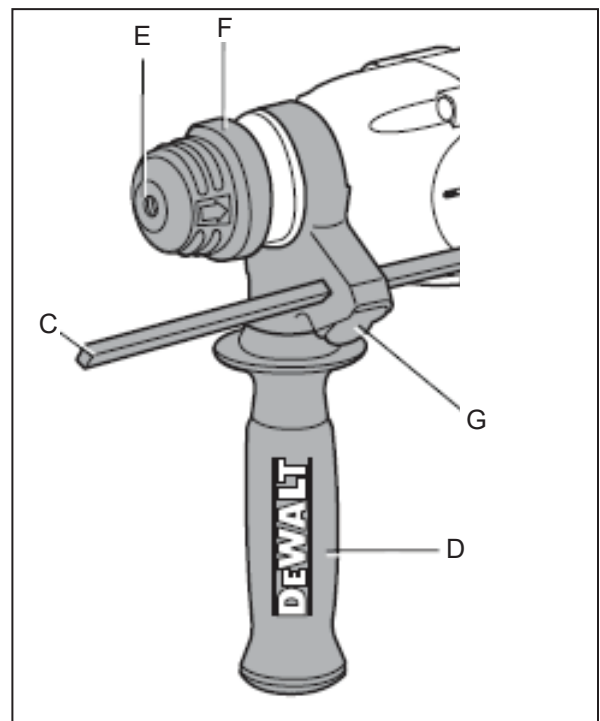

Figure 3: Side Handle and Depth Gauge

OPERATION

a clockwise direction.

Do not clamp the side handle to the front nose collar. Clamp the handle to the housing, against the body shoulder. The side handle should be securely attached to the hammer drill during operation.

BIT INSTALLATION

Bits with SDS Plus shanks are mounted directly into the tool holder of the hammer drill. It is a good practice to slightly grease the bit shanks before inserting them.

To install SDS Plus shanked bits or the bull-point chisel bit, insert the bit shank into the tool holder/locking sleeve. Then push the bit down and turn it slightly until it fits into the slots. Pull on the bit to check if it is properly locked. To remove the bit, push down on the tool holder/locking sleeve (F) (See figure 3) and pull out the bit.

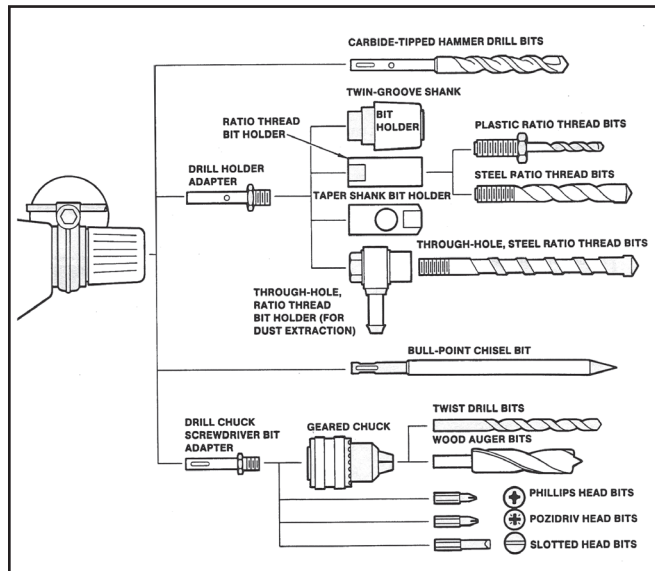

Figure 4: Hammer Drill Accessories

To install twin-groove shank, ratio thread shank, taper shank or through-hole shank bits, install the Drill Holder Adapter as described above. Then simply screw the appropriate bit holder onto the drill holder adapter. Figure 4 illustrates these adapters and bit holders.

To install the Geared Chuck for use with standard drill bits and screwdriver bits in non-percussion drill mode, install the Drill Chuck/Screwdriver Bit Adapter as described above. Then install the appropriate bit into the Geared Chuck and tighten with the chuck key. Figure 4 illustrates the adapter, Geared Chuck, and various standard bits.

DRILL OPERATION

Operate the HD01 Hammer Drill as follows:

1. Observe all safety precautions.
2. Install the appropriate adapters bits into the hammer drill.
3. Set the hammer drill controls, side handle and depth gauge. Refer to "CONTROLS" on page 10 for details.

IMPORTANT

When operating the drill in hammer mode, always use drill bits and accessories designed for impact type applications. **DO NOT USE STANDARD DRILL BITS OR ACCESSORIES. THESE CAN CRACK OR FRACTURE DURING OPERATION.**

4. Move the hydraulic circuit control valve to the **ON** position.
5. Squeeze the trigger to activate the drill.
6. Release the trigger to stop the drill.

MODES OF OPERATION

The hammer drill can operate in either drill only mode (without percussion), hammer drill mode (drill with percussion) or hammer only mode (with percussion).

In drill only mode, the hammer drill can be used for periodic light duty drilling.

The following sections provide operational guidelines for drilling, hammer drilling or chiselling.

DRILLING (NON-PERCUSSION)

Use the Drill Chuck/Screwdriver Bit Adapter and the Geared Chuck for periodic, light-duty drilling applications.

With the Geared Chuck mounted on the tool, loosen the chuck first with the chuck key, and then turn the chuck sleeve counterclockwise (looking at the chuck end of the tool) by hand. Loosen until the bit shank fits into the hole for the shank. Insert the appropriate bit shank into the chuck and tighten the chuck sleeve clockwise by hand. Tighten further by applying the chuck key successively to all three guide holes of the chuck.

The chuck key must not be attached to the tool with a chain, cord, or similar means.

When drilling into small work pieces, secure the piece (by clamping in a vise or otherwise securing it to the work surface) so that the piece is not turned by the drill bit during drilling.

OPERATION

IMPORTANT

When drilling into a structure that might contain electrical wiring, be sure to know the location of the wiring and avoid drilling into it. The housing can carry electrical current from live electrical wires into the drill which can result in injury or death.

HAMMER DRILLING (PERCUSSION)

Press the hammer drill bit against the work surface before squeezing the trigger. Do not operate the drill before contacting the work surface.

When hammer drilling, do not exert heavy pressure on the tool. Applying heavy pressure does not increase the drilling speed. You need only press lightly. When the drill is withdrawn from the work surface, the percussion action of the hammer drill stops.

CHISELLING

Use the Bull-point Chisel Bit for light-duty chiselling work. Press the hammer drill chisel bit against the work surface before squeezing the trigger. As with hammer drilling, do not exert heavy pressure on the tool. Press lightly.

Bull-point chisels that become blunt can be sharpened on a grinding machine.

LUBRICATION

Your tool was properly lubricated before leaving the factory. In two to six months, depending on use, take your tool to an authorized service center for a complete cleaning, inspection and lubrication. Tools used constantly on production jobs will need lubrication more often. Also tools “out of service” for long periods should be lubricated before being put back to work.

COLD WEATHER OPERATION

If the drill is to be used during cold weather, preheat the hydraulic fluid at low engine speed. When using the normally recommended fluids, fluid temperature should be at or above 50 °F/10 °C (400 SSU/ 82 centistokes) before use.

Damage to the hydraulic system or drill can result from use with fluid that is too viscous or too thick.

TOOL PROTECTION & CARE

NOTICE

In addition to the Safety Precautions found in this manual, observe the following for equipment protection and care.

- Make sure all couplers are wiped clean before connection
- The hydraulic circuit control valve must be in the **OFF** position when coupling or uncoupling hydraulic tools. Failure to do so may result in damage to the quick couplers and cause overheating of the hydraulic system.
- Always store the tool in a clean dry space, safe from damage or pilferage.
- Make sure the circuit **PRESSURE** hose (with male quick disconnect) is connected to the **IN** port. The circuit **RETURN** hose (with female quick disconnect) is connected to the opposite port. Do not reverse circuit flow. This can cause damage to internal seals.
- Always replace hoses, couplings and other parts with replacement parts recommended by STANLEY. Supply hoses must have a minimum working pressure rating of 2500 psi/172 bar.
- Do not exceed the rated flow. Refer to “Specifications” on page 17 for correct flow rate and model number. Rapid failure of the internal seals may result.
- Always keep critical tool markings, such as warning stickers and tags, legible.
- Tool repair should be performed by experienced personnel only.
- Make certain that the recommended relief valves are installed in the pressure side of the system.
- Do not use the tool for applications for which it was not intended.

LOCKOUT KIT OC/CC

DUAL SPOOL FEATURES FOR THE HD01 HAMMER DRILL

KIT P/N-73018

IMPORTANT

This tool is furnished with an on-off valve spool, commonly referred to as a “dual spool”, which permits adjustment so the tool may be operated on either an open-center hydraulic system or a closed-center hydraulic system. The dual spool is normally set to the open-center (OC) position at time of manufacture. The dual spool can also be disabled so that the tool may be set to open-center only operation or closed-center only operation. For more details, please refer to the following instructions.

SETTING THE TOOL FOR EITHER OPEN-CENTER OR CLOSED-CENTER HYDRAULIC SYSTEM OPERATION

To change the tool to closed-center (CC) system operation, locate the knurled knob on the spool end. Note that the knob contains two set screws which are located directly opposite one another. Turn the knurled knob so that the set screws are on a horizontal or cross-wise line. To change the tool to open-center (OC) system operation, turn the knurled knob so that the set screws are on a vertical or up and down line. For more detailed information on making these adjustments, refer to the User Manual.

TO DISABLE DUAL SPOOL OPERATION AND CONVERT TO OPEN-CENTER OR CLOSED-CENTER ONLY OPERATION

The on-off valve spool commonly referred to as a “dual spool” can be set to open-center or closed-center operation and then locked in position. The lock disables the normal method for adjusting the dual spool so that the tool cannot be changed from one hydraulic system setting to another (OC to CC or CC to OC) without first removing the lock. The parts included in this kit are required to disable the dual spool operation and install the lock. If you do not wish to disable the dual spool operation, you may discard this kit. To install the kit, refer to the instructions below.

FOR OPEN-CENTER (OC) SYSTEM OPERATION ONLY:

1. Turn the knurled knob so that the two set screws are on a vertical or up and down line.
2. At the end of the valve spool opposite from the knob is an O-ring which retains two steel balls. Remove the O-ring and the two (2) steel balls.
3. Obtain the set screw from the kit and install it (use a small amount of Loctite) in the threaded hole located in the O-ring groove (the groove for the O-ring which you just removed). Tighten the set screw until snug and then back off 1/2 turn. Check to make sure the valve spool moves freely.
4. Replace the two steel balls and the O-ring.

FOR CLOSED-CENTER (CC) SYSTEM OPERATION ONLY:

1. Turn the knurled knob so that the two set screws are on a horizontal or cross wise line.
2. At the end of the valve spool opposite from the knob is an O-ring which retains two steel balls. Remove the O-ring and the two (2) steel balls.
3. Obtain the set screw from the kit and install it (use a small amount of Loctite) in the threaded hole located in the O-ring groove (the groove for the O-ring which you just removed). Tighten the set screw until snug and then back off 1/2 turn. Check to make sure the valve spool moves freely.
4. Replace the two steel balls and the O-ring.

TROUBLESHOOTING

If symptoms of poor performance develop, the following chart can be used as a guide to correct the problem.

When diagnosing faults in operation of the hammer drill, always check that the hydraulic power source is supplying the correct hydraulic flow and a pressure to the tool as listed in the table. Use a flowmeter known to be accurate. Check the flow with the hydraulic fluid temperature at least 80 °F/27 °C.

PROBLEM	CAUSE	SOLUTION
Drill will not start	Power not being supplied.	Check to make certain that both hoses are connected.
		Turn hydraulic circuit control valve ON.
	Defective quick disconnect.	Check each disconnect separately. Replace as necessary.
	Jammed motor and/or parts.	Separate modules and inspect. See Service manual. Do not force parts together.
	Flow reversed through hoses.	Correct the power source control valve position. Prevent reverse flow by using only one port from the valve for pressure, the return tool hose to the cooler and the filter line. Correct the quick disconnect male/female routing per instructions and arrows on the fittings.
Low hammer impact or drilling torque.	Incorrect hydraulic flow.	Check that the hydraulic power source is producing 4–9 GPM/15–34 LPM at 750–2000 psi/53–140 bar.
	Defective quick disconnect.	Check each disconnect separately.
	Worn impact mechanism.	Separate modules and repair or replace impact mechanism. See Service section.
	Incorrect grease.	DeWALT (forward module) mechanism is full of fluid or contaminants or is improperly greased. Clean out, re-lubricate, and/or repair per DeWALT instructions. See instructions for separating the rear module to supply DeWALT portion to the dealer for service.
	Reversing spool incorrectly installed.	Reversing spool upside down. Do not separate modules. See Service section.
	Hydraulic circuit relief set too low, hoses too restrictive or the hydraulic fluid is too thick.	Set relief valve at 2100 psi/145 bar. See Service section.
	Fluid restriction in hose or valve. Excess back pressure.	Locate and remove restriction.
		Use correct fluid.
		Fluid not warmed-up. Preheat system.
		Hoses too long for hose ID. Use shorter hose.
Priority flow control valve or reverse check valve is malfunctioning.	Do not separate modules. See Service section.	
Flow reversed through hoses.	Correct the power source control valve position. Prevent reverse flow by using only one port from the valve for pressure, the return tool hose to the cooler and the filter line. Correct the quick disconnect male/female routing per instructions and the arrows on the fittings.	

TROUBLESHOOTING

PROBLEM	CAUSE	SOLUTION
Drill operates in only one direction.	Reverse spool incorrectly installed.	Do not separate modules. Reassemble. See Service section.
	Reverse spool faulty.	Do not separate modules. Replace reverse spool. See Service section.
	Tool hose flow is reversed.	Tool must not be reversed by reversing hose flow. The tool is only designed for flow as indicated by the designations cast on the housing.
Drill runs too fast. Impact mechanism or screws broken.	Incorrect hydraulic flow.	Check the hydraulic power source is not producing over 9 GPM/34 LPM at 750–2000 psi/53–140 bar.
	Hydraulic flow reversed.	Correct the tool hoses. IN and OUT per instructions and if the power supply valve is reversible, reconnect the tool return hose to the oil cooler or to the filter directly.
	Priority valve faulty.	Do not separate modules. Remove, inspect and replace priority valve if necessary. See Service section.
Trigger operation erratic. Control difficult.	Trigger mechanism and strut area blocked by debris.	Do not separate modules. Clean trigger area. See Service section.
Fluid leaks at housing seam.	Motor screws loose.	Separate modules. Tighten to recommended torque.
	Motor cap seal worn or missing.	Separate modules. Replace as required.
	Motor cap/main housing damaged.	Separate modules. Replace as required.
Fluid leaks at reversing spool.	Damaged O-rings.	Do not separate modules. Replace them as required.
	Wrong hydraulic fluid. Circuit too hot.	See Operation section for correct fluid/circuit specifications.
	Hydraulic pressure and return hoses reversed.	Correct hose connections.
Fluid leak at air gap between module.	Oil leak at motor shaft seal.	Repair or replace. See Service section.
Fluid gets hot. Power unit working hard.	Open center tool on a closed center circuit or vice versa.	Use tools to match circuit.
	Circuit relief set too low.	Adjust relief valve to 2100–2250 psi/135–155 bar.
	Too much fluid going through tool.	Adjust flow for 9 GPM/34 LPM maximum.
	Circuit is generating high heat with flow controls.	Use pump size and rpm for producing needed flow only. Eliminate circuit heating causes.
	Circuit has contaminants that have caused wear and high heat generation.	Replace worn pump and valves. Install a large clean filter and keep the fluid clean.

SPECIFICATIONS

Rotation Speed at 6 GPM.....	800 rpm
Blows per Minute at 6 GPM.....	4200 blows
Weight without Couplers.....	9.1 lbs/4.1 kg
Weight w/Hose Whips & Couplers.....	10.2 lbs/4.6 kg
Length.....	14.1 in./36 cm
Height.....	5.6 in./14 cm
Pressure.....	750-2000 psi/50-140 bar
Flow Range.....	3-9 GPM/11-34 LPM
Optimum Flow.....	6 GPM/22.8 LPM
Porting.....	-8 SAE O-ring
Connect Size and Type.....	-8 SAE O-ring
Collar Diameter.....	54 mm / 2.1 in.
Motor.....	Integral
Tool Holder/Bit Type.....	SDS Plus

SOUND POWER AND VIBRATION DECLARATION	
Measured A-weighted sound power level, Lwa (ref. 1pW) in decibels	100.3 dBA
Uncertainty, Kwa, in decibels	3 dBA
Measured A-weighted sound pressure level, Lpa (ref. 20 µPa) at operator's position, in decibels	92.3 dBA
Uncertainty, Kpa, in decibels	3 dBA
Values determined according to noise test code given in ISO 15744, using the basic standard ISO 3744 NOTE: The sum of a measured noise emission value and its associated uncertainty represents an upper boundary of the range of values which is likely to occur in measurements.	
Declared vibration emission value in accordance with EN 12096	
Measured vibration emission value: a	15.8 m/sec ²
Uncertainty: K	0.99 m/sec ²
Values determined according to ISO 28927-10:2011	

ACCESSORIES

DESCRIPTION	PART NUMBER
1/2-inch Friction Chuck with Adaptor.....	72992
Carbide Bit 3/8 in. x 12 in. OAL.....	27807
Carbide Bit 1/2 in. x 12 in. OAL.....	27814
Carbide Bit 3/4 in. x 12 in. OAL.....	27826
Carbide Bit 3/4 in. x 18 in. OAL.....	27827
Carbide Bit 7/8 in. x 18 in. OAL.....	27832

SERVICE PARTS

DESCRIPTION	PART NUMBER
Seal Kit.....	72864
Service Kit (Includes items 6, and 59 thru 62 see illustration).....	72661

HD01 PARTS ILLUSTRATION

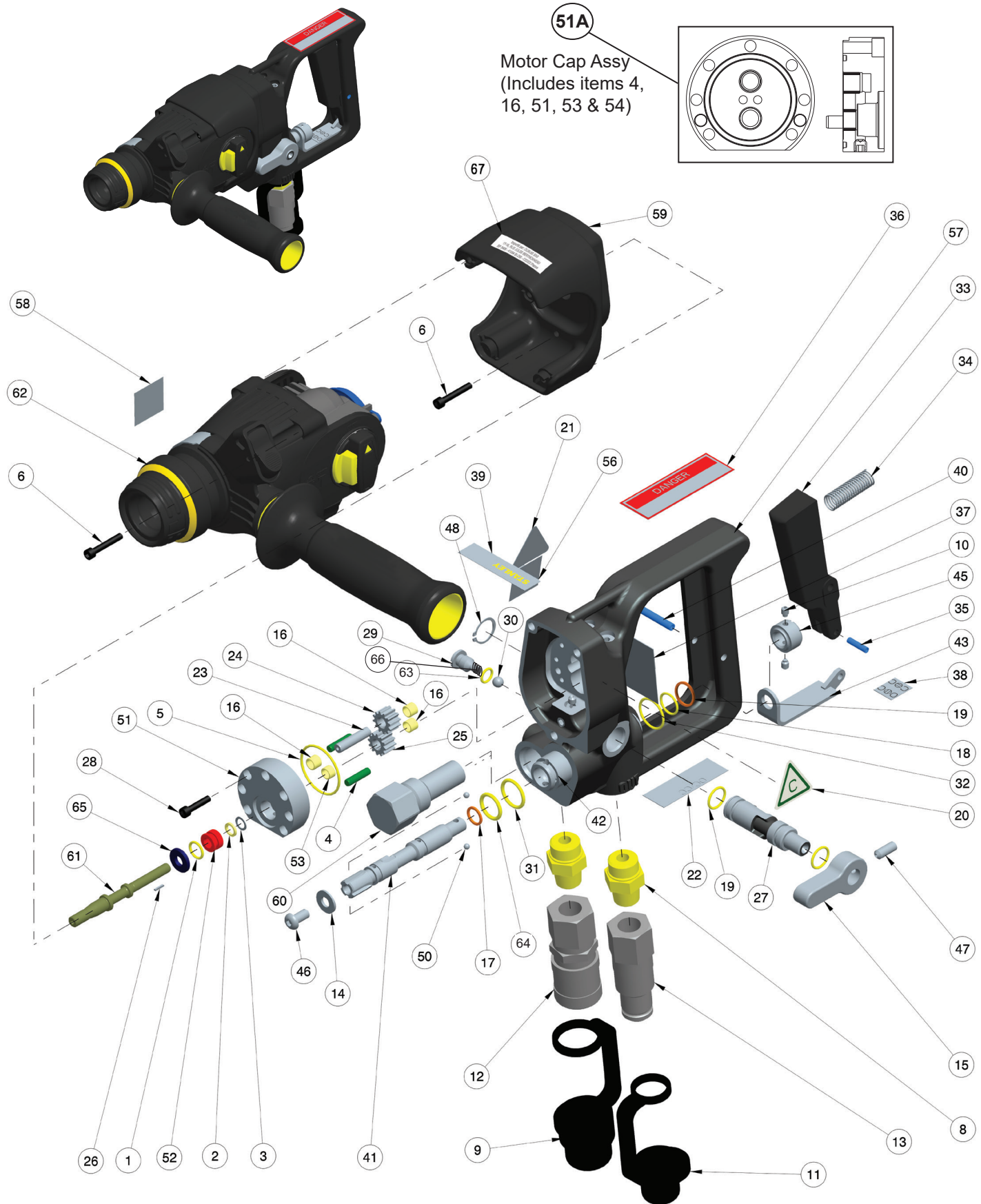

HD01 PARTS LIST

ITEM	P/N	QTY	DESCRIPTION
1	00106	1	* O-RING 3/8 X 1/2 X 1/16 -012
2	00112	1	* QUAD RING 1/4 X 3/8 X 1/16 -010
3	00179	1	MOTOR SEAL WASHER
4	00289	2	DOWEL PIN 3/16 X 3/4 LG.
5	00621	1	* O-RING 1-1/4 X 1-3/8 X 1/16 -026
6	00779	7	HSHCS 8-32 X 1.000
7	00783	7	PIPE PLUG (NOT PICTURED) PART OF ITEM 57
8	00936	2	ADAPTER -8 (1/2) SAE X 3/8 NPT
9	02324	1	CAP & PLUG 1/2"
10	02837	2	SETSCREW 10-24 X 1/4
11	03288	1	CAP & PLUG 3/8"
12	03972	1	COUPLER,3/8FEM.3/8NPTFL.FACESET 03971
13	03973	1	COUPLER,3/8MALE 3/8NPT FL.FACE SET 03971
14	04539	1	WASHER 1/4" I.D.
15	04939	1	LEVER
16	05205	3	BUSHING, GARLOCK 04DU04
17	07223	1	* BACK-UP RING -012
18	07626	1	* O-RING 1/2 X 5/8 X 1/16 -014
19	07224	1	* BACK-UP RING -014
20	11206	1	CIRCUIT TYPE "C" STICKER
21	11207	1	CIRCUIT TYPE "D" STICKER
22	11354	1	OC/CC STICKER
23	15890	1	IDLER SHAFT
24	15894	1	IDLER GEAR
25	15895	1	DRIVE GEAR
26	15896	1	KEY
27	15904	1	REVERSING SPOOL
28	15909	7	HSHCS 8-32 X 3/4
29	15956	1	CHECK PLUG
30	15966	1	STEEL BALL 9/32
31	17924	1	* O-RING .644 X .818 X .087 -908
32	16555	1	* O-RING 3/4 X 7/8 X 1/16 -018
33	16598	1	TRIGGER
34	16647	1	COMPRESSION COIL SPRING
35	16648	1	ROLL PIN 5/32 O.D. X .625 LG.
36	17160	1	DANGER STICKER
37	09612	1	GENERAL CAUTION STICKER
38	17162	1	OC/CC STICKER
39	76648	1	TOOL NAME TAG
40	17668	1	ROLL PIN 3/16 O.D. X 1.250 LG.

ITEM	P/N	QTY	DESCRIPTION
41	17811	1	SPOOL OC/CC
42	----	1	ON/OFF VALVE SLEEVE (PART OF ITEM 57)
43	17815	1	TRIGGER STRUT
44	----	--	ON ITEM
45	17817	1	KNOB OC/CC
46	17821	1	1/4-20 X 1/2 BUTTON HEAD H.S.
47	17897	1	SETSCREW 1/4-20 X .625
48	17904	1	RETAINING RING EXTERNAL
49	18277	7	HELICOIL 8-32 UNC (NOT PICTURED) PART OF ITEM 57
50	21338	2	STEEL BALL 5/32
51	23326	1	MOTOR CAP
51A	23330	1	MOTOR CAP ASSY (INCLUDES ITEMS 4, 16, 51, 53 & 54)
52	23327	1	SEAL LINER
53	23328	1	MODIFIED DU BEARING
54	23329	1	SETSCREW (NOT PICTURED) PART OF ITEM 57
56	88348	1	STICKER - MANUAL
57	47451	1	MAIN HOUSING ASSEMBLY INCLUDES ITEMS 7, 16, 29-32, 42, 49, & 63
58	81435	1	SOUND POWER LEVEL STICKER
59	72638	1	ADAPTOR ASSY
60	72728	1	PRIORITY FLOW CONTROL 5 GPM
61	72729	1	MOTOR SHAFT
62	72733	1	DEWALT GEARBOX ASSEMBLY
63	350792	1	* O-RING .301 X .365 X .064 -903
64	350810	1	* O-RING 9/16 X 3/4 X 3/32 -113
65	72915	1	WASHER
66	01602	1	COMPRESSION COIL SPRING
	73018	1	LOCK-OUT KIT (SHIPS UNINSTALLED)
	28323	1	CEDECAL-NOT PICTURED, ATTACHED ON SIDE OF GEARBOX.
67	88344	1	IMPORTER DECAL

* DENOTES PART IN SEAL KIT
SEAL KIT PART NUMBER 72864

HD01 SERVICE KIT 72661 (INCLUDES ITEM NUMBER 6, 59, 60, 61 and 62)

STANLEY®

STANLEY Infrastructure
6430 SE Lake Road
Portland, Oregon 97222 USA
(503) 659-5660 / Fax (503) 652-1780
www.stanleyinfrastructure.com