

# STANLEY®

# IW16 HYDRAULIC IMPACT WRENCH

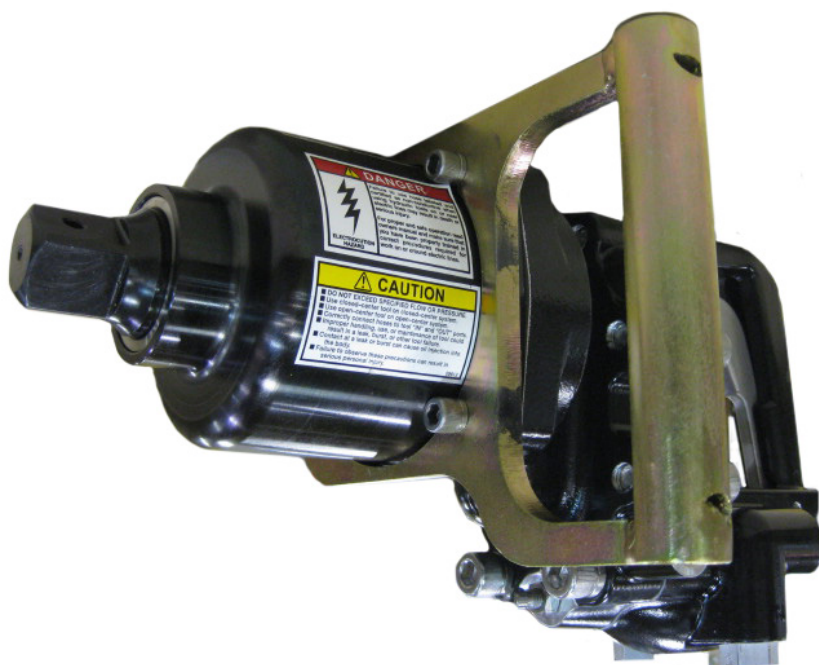

## USER MANUAL Safety, Operation and Maintenance



© 2014 Stanley Black & Decker, Inc.  
New Britain, CT 06053  
U.S.A.  
66174 2/2015 Ver 15

# DECLARATION OF CONFORMITY

DECLARATION OF CONFORMITY  
ÜBEREINSTIMMUNGS-ERKLÄRUNG  
DECLARATION DE CONFORMITE CEE  
DECLARACION DE CONFORMIDAD  
DICHIARAZIONE DI CONFORMITA

**STANLEY**  
Hydraulic Tools  
**CE**

I, the undersigned:  
Ich, der Unterzeichnende:  
Je soussigné:  
El abajo firmante:  
Io sottoscritto:

**Weisbeck, Andy**

Surname and First names/Familiennamen und Vornamen/Nom et prénom/Nombre y apellido/Cognome e nome

hereby declare that the equipment specified hereunder:  
bestätige hiermit, daß erklaren Produkt genannten Werk oder Gerät:  
déclare que l'équipement visé ci-dessous:  
Por la presente declaro que el equipo se especifica a continuación:  
Dichiaro che le apparecchiature specificate di seguito:

1. Category: **Hydraulic Hand Held Impact Wrench**  
Kategorie:  
Catégorie:  
Categoria:  
Categoria:

2. Make/Marke/Marque/Marca/Marca **Stanley**

3. Type/Typ/Type/Tipo/Tipo: **IW16150, IW16150S, IW16350**

4. Serial number of equipment:  
Seriennummer des Geräts:  
Numéro de série de l'équipement:  
Numero de serie del equipo:  
Matricola dell'attrezzatura:

**ALL MODELS NOTED ABOVE FROM  
SERIAL NUMBER (042312097) and Above**

Has been manufactured in conformity with  
Wurde hergestellt in Übereinstimmung mit  
Est fabriqué conformément  
Ha sido fabricado de acuerdo con  
E' stata costruita in conformità con

Directive/Standards Richtlinie/Standards Directives/Normes Directriz/Los Normas Direttiva/Norme	No. Nr Numéro No n.	Approved body Prüfung durch Organisme agréé Aprobado Collaudato
EN	11148-6:2010	Self
EN ISO	3744:2010	Self
EN	28927-2:2009	Self
Machinery Directive	2006/42/EC:2006	Self

5. Special Provisions: **None**  
Spezielle Bestimmungen:  
Dispositions particulières:  
Provisiones especiales:  
Disposizioni speciali:

6. Representative in the Union: **Patrick Vervier, Stanley Dubuis 17-19, rue Jules Berthonneau-BP 3406 41034 Blois Cedex, France.**  
Vertreter in der Union/Représentant dans l'union/Representante en la Union/Rappresentante presso l'Unione

Done at/Ort/Fait à/Dado en/Fatto a Stanley Hydraulic Tools, Milwaukie, Oregon USA Date/Datum/le/Fecha/Data 12-22-10

Signature/Unterschrift/Signature/Firma/Firma

*Andy Weisbeck*

Position/Position/Fonction/Cargo/Posizione Director of Product Development

# TABLE OF CONTENTS

DECLARATION OF CONFORMITY .....	2
SAFETY SYMBOLS .....	4
SAFETY PRECAUTIONS.....	5
TOOL STICKERS & TAGS .....	6
HOSE TYPES.....	7
HOSE RECOMMENDATIONS .....	8
FIGURE 1. TYPICAL HOSE CONNECTIONS .....	8
HTMA REQUIREMENTS.....	9
WRENCH TORQUE INFORMATION .....	10
WRENCH OPERATION .....	11
EQUIPMENT PROTECTION & CARE .....	12
TROUBLESHOOTING .....	13
SPECIFICATIONS.....	14
ACCESSORIES.....	15
IW16 PARTS ILLUSTRATION .....	16
IW16 PARTS LIST .....	17
VALVE HANDLE CHANGE NOTICE.....	18
IW16 EXTENSION HANDLE ILLUSTRATION .....	19
UNDERWATER TOOLS DEPTH GUIDELINE.....	20

## IMPORTANT

To fill out a Product Warranty Validation form, and for information on your warranty, visit [Stanleyhydraulics.com](http://Stanleyhydraulics.com) and select the Company tab, Warranty.  
(NOTE: The warranty Validation record must be submitted to validate the warranty).

**SERVICING:** This manual contains safety, operation, and routine maintenance instructions. Stanley Hydraulic Tools recommends that servicing of hydraulic tools, other than routine maintenance, must be performed by an authorized and certified dealer. Please read the following warning.

## ⚠ WARNING

**SERIOUS INJURY OR DEATH COULD RESULT FROM THE IMPROPER REPAIR OR SERVICE OF THIS TOOL.**

**REPAIRS AND / OR SERVICE TO THIS TOOL MUST ONLY BE DONE BY AN AUTHORIZED AND CERTIFIED DEALER.**

For the nearest authorized and certified dealer, call Stanley Hydraulic Tools at the number listed on the back of this manual and ask for a Customer Service Representative.

# SAFETY SYMBOLS

Safety symbols and signal words, as shown below, are used to emphasize all operator, maintenance and repair actions which, if not strictly followed, could result in a life-threatening situation, bodily injury or damage to equipment.



This is the safety alert symbol. It is used to alert you to potential personal injury hazards. Obey all safety messages that follow this symbol to avoid possible injury or death.

This safety alert and signal word indicate an imminently hazardous situation which, if not avoided, will result in death or serious injury.

This safety alert and signal word indicate a potentially hazardous situation which, if not avoided, could result in death or serious injury.

This safety alert and signal word indicate a potentially hazardous situation which, if not avoided, could result in death or serious injury.

This signal word indicates a potentially hazardous situation which, if not avoided, may result in property damage.

This signal word indicates a situation which, if not avoided, will result in damage to the equipment.

This signal word indicates a situation which, if not avoided, may result in damage to the equipment.

Always observe safety symbols. They are included for your safety and for the protection of the tool.

## LOCAL SAFETY REGULATIONS

Enter any local safety regulations here. Keep these instructions in an area accessible to the operator and maintenance personnel.

---

---

---

---

---

---

---

---

---

---

# SAFETY PRECAUTIONS

Tool operators and maintenance personnel must always comply with the safety precautions given in this manual and on the stickers and tags attached to the tool and hose. These safety precautions are given for your safety. Review them carefully before operating the tool and before performing general maintenance or repairs.

Supervising personnel should develop additional precautions relating to the specific work area and local safety regulations. If so, place the added precautions in the space provided in this manual.

The model IW16 Hydraulic Impact Wrench will provide safe and dependable service if operated in accordance with the instructions given in this manual. Read and understand this manual and any stickers and tags attached to the tool and hose before operation.

Failure to do so could result in personal injury or equipment damage.



- The operator must start in a work area without bystanders. Flying debris can cause serious injury.
- Do not operate the tool unless thoroughly trained or under the supervision of an instructor. Establish a training program for all operators to ensure safe operation.
- Always wear safety equipment such as goggles, gloves, ear, head and breathing protection, and safety shoes at all times when operating the tool. Use gloves and aprons when necessary.
- Inspect tool daily for loose fasteners, missing parts and leakage. Have tool repaired if necessary.
- The operator must be familiar with all prohibited work areas such as excessive slopes and dangerous terrain conditions.
- Maintain proper footing and balance at all times and do not overreach.
- Do not inspect or clean the tool while the hydraulic power source is connected. Accidental engagement of the tool can cause serious injury. Be observant of hydraulic and water hose lying about the work area, they can be a tripping hazard.
- Always connect hoses to the tool hose couplers before energizing the hydraulic power source. Be sure all hose connections are tight and are in good condition.
- Do not operate the tool at oil temperatures above 140 °F/60 °C. Operation at higher temperatures can cause higher than normal temperatures at the tool which can result in operator discomfort.
- Do not operate a damaged, improperly adjusted, or incompletely assembled impact wrench.
- Never wear loose clothing that can get entangled in the working parts of the tool.
- Keep all parts of your body away from the rotating parts. Long hair or loose clothing can become drawn into rotating components.
- Always use accessories that conform to the specifications given in the OPERATION section of this manual.
- Do not reverse impact wrench rotation direction by changing fluid flow direction.
- Release the trigger if the power supply has been interrupted.
- When working near electrical conductors, always assume that all conductors are energized and that insulation, clothing and hoses can conduct electricity. Use hose labeled and certified as non-conductive.
- To avoid personal injury or equipment damage, all tool repair, maintenance and service must only be performed by authorized and properly trained personnel.
- Serious injury or death could result from a tool or accessories dropped from an elevated height, also flying debris can cause serious injury.
- Warning: Hydraulic fluid under pressure could cause skin injection injury. If you are injured by hydraulic fluid, get medical attention immediately.
- During operation do not contact the impact mechanism, accessories or hardware as they can become very hot, use your (PPE) Personal Protection Equipment.
- **Warning:** Use of this tool on certain materials during demolition could generate dust potentially containing a variety of hazardous substances such as asbestos, silica or lead. Inhalation of dust containing these or other hazardous substances could result in serious injury, cancer or death. Protect yourself and those around you. Research and understand the materials you are cutting. Follow correct safety procedures and comply with all applicable national, state or provisional health and safety regulations relating to them, including, if appropriate arranging for the safe disposal of the materials by a qualified person.

# TOOL STICKERS & TAGS

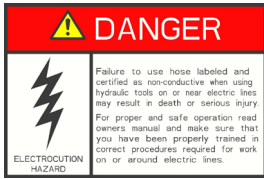

12412 DANGER DECAL

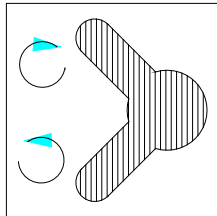

30136 ROTATION DIRECTION DECAL



25610 RAILROAD HELP DESK DECAL

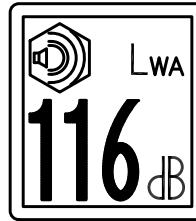

66305 SOUND POWER LEVEL DECAL (CE)



28788 MANUAL DECAL (CE)



11207 CIRCUIT TYPE D DECAL (CE)



12535 CIRCUIT TYPE E DECAL (CE)

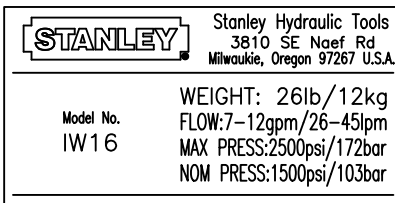

08153 IW16 NAME TAG (US & CE)

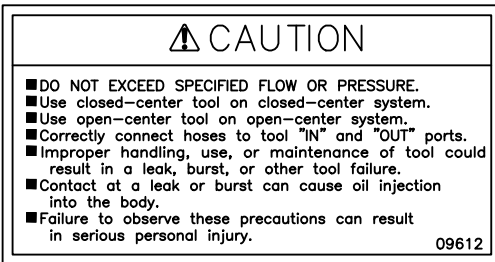

09612 GPM DECAL

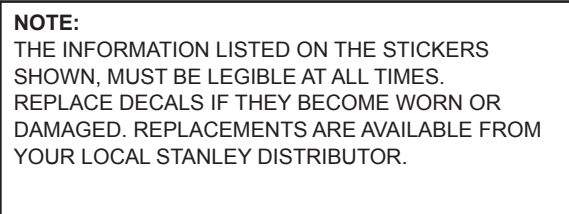

The safety tag (P/N 15875) at right is attached to the tool when shipped from the factory. Read and understand the safety instructions listed on this tag before removal. We suggest you retain this tag and attach it to the tool when not in use.

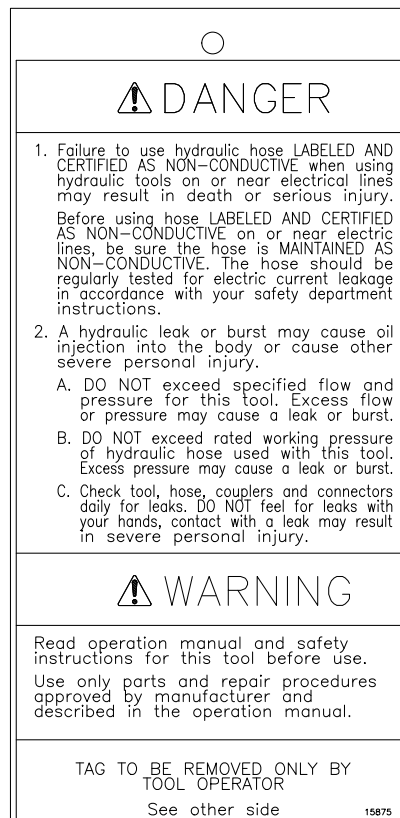

SAFETY TAG P/N 15875 (shown smaller than actual size)



# HOSE TYPES

The rated working pressure of the hydraulic hose must be equal to or higher than the relief valve setting on the hydraulic system. There are three types of hydraulic hose that meet this requirement and are authorized for use with Stanley Hydraulic Tools. They are:

**Certified non-conductive** — constructed of thermoplastic or synthetic rubber inner tube, synthetic fiber braid reinforcement, and weather resistant thermoplastic or synthetic rubber cover. *Hose labeled **certified non-conductive** is the only hose authorized for use near electrical conductors.*

**Wire-braided** (conductive) — constructed of synthetic rubber inner tube, single or double wire braid reinforcement, and weather resistant synthetic rubber cover. *This hose is **conductive** and must never be used near electrical conductors.*

**Fabric-braided** (not certified or labeled non-conductive) — constructed of thermoplastic or synthetic rubber inner tube, synthetic fiber braid reinforcement, and weather resistant thermoplastic or synthetic rubber cover. *This hose is **not certified non-conductive** and must never be used near electrical conductors.*

## HOSE SAFETY TAGS

To help ensure your safety, the following DANGER tags are attached to all hose purchased from Stanley Hydraulic Tools. **DO NOT REMOVE THESE TAGS.**

If the information on a tag is illegible because of wear or damage, replace the tag immediately. A new tag may be obtained from your Stanley Distributor.

### THE TAG SHOWN BELOW IS ATTACHED TO “CERTIFIED NON-CONDUCTIVE” HOSE

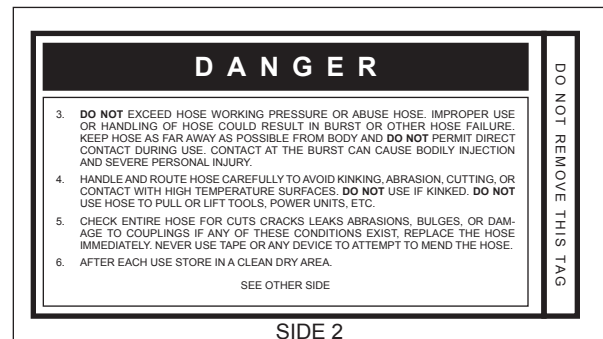
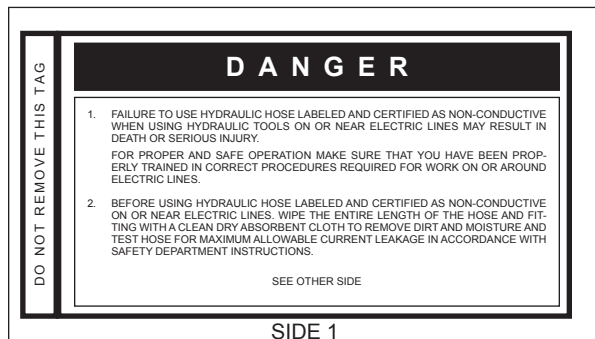

(Shown smaller than actual size)

### THE TAG SHOWN BELOW IS ATTACHED TO “CONDUCTIVE” HOSE.

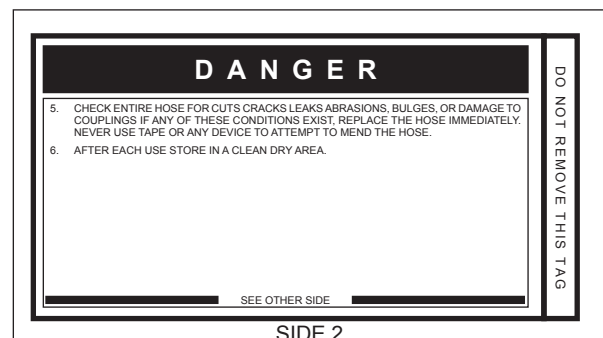
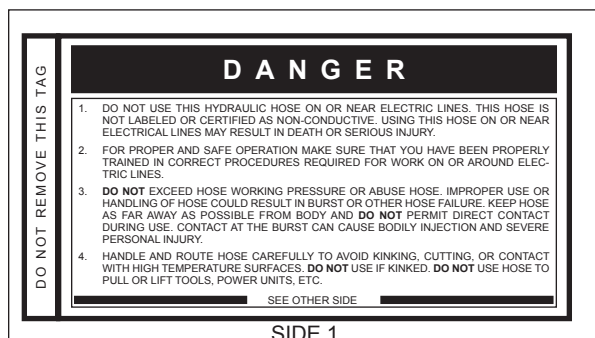

(Shown smaller than actual size)

# HOSE RECOMMENDATIONS

## Tool to Hydraulic Circuit Hose Recommendations

The chart to the right shows recommended minimum hose diameters for various hose lengths based on gallons per minute (gpm)/liters per minute (lpm). These recommendations are intended to keep return line pressure (back pressure) to a minimum acceptable level to ensure maximum tool performance.

This chart is intended to be used for hydraulic tool applications only based on Stanley Hydraulic Tools tool operating requirements and should not be used for any other applications.

All hydraulic hose must have at least a rated minimum working pressure equal to the maximum hydraulic system relief valve setting.

**All hydraulic hose must meet or exceed specifications as set forth by SAE J517.**

Oil Flow		Hose Lengths		Inside Diameter		USE (Press/Return)	Min. Working Pressure	
GPM	LPM	FEET	METERS	INCH	MM		PSI	BAR
<b>Certified Non-Conductive Hose - Fiber Braid - for Utility Bucket Trucks</b>								
4-9	15-34	up to 10	up to 3	3/8	10	Both	2250	155
<b>Conductive Hose - Wire Braid or Fiber Braid - DO NOT USE NEAR ELECTRICAL CONDUCTORS</b>								
4-6	15-23	up to 25	up to 7.5	3/8	10	Both	2500	175
4-6	15-23	26-100	7.5-30	1/2	13	Both	2500	175
5-10.5	19-40	up to 50	up to 15	1/2	13	Both	2500	175
5-10.5	19-40	51-100	15-30	5/8	16	Both	2500	175
5-10.5	19-40	100-300	30-90	5/8	16	Pressure	2500	175
10-13	38-49	up to 50	up to 15	3/4	19	Return	2500	175
10-13	38-49	51-100	15-30	5/8	16	Both	2500	175
10-13	38-49	100-200	30-60	3/4	19	Pressure	2500	175
13-16	49-60	up to 25	up to 8	5/8	16	Return	2500	175
13-16	49-60	26-100	8-30	3/4	19	Pressure	2500	175
				1	25.4	Return	2500	175
				5/8	16	Pressure	2500	175
				3/4	19	Return	2500	175
				3/4	19	Pressure	2500	175
				1	25.4	Return	2500	175

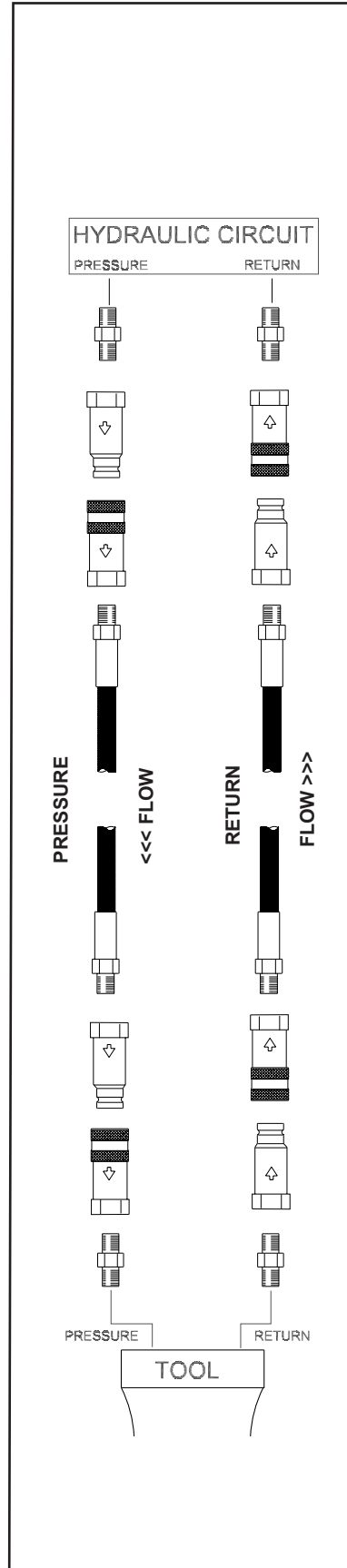

Figure 1. Typical Hose Connections



# HTMA / EHTMA REQUIREMENTS

## HTMA / EHTMA REQUIREMENTS

### HTMA

#### HYDRAULIC SYSTEM REQUIREMENTS

#### TOOL TYPE

	TYPE I	TYPE II	TYPE RR	TYPE III
Flow Range	4-6 gpm (15-23 lpm)	7-9 gpm (26-34 lpm)	9-10.5 gpm (34-40 lpm)	11-13 gpm (42-49 lpm)
Nominal Operating Pressure (at the power supply outlet)	1500 psi (103 bar)	1500 psi (103 bar)	1500 psi (103 bar)	1500 psi (103 bar)
System relief valve setting (at the power supply outlet)	2100-2250 psi (145-155 bar)	2100-2250 psi (145-155 bar)	2200-2300 psi (152-159 bar)	2100-2250 psi (145-155 bar)
Maximum back pressure (at tool end of the return hose)	250 psi (17 bar)	250 psi (17 bar)	250 psi (17 bar)	250 psi (17 bar)
Measured at a max. fluid viscosity of: (at min. operating temperature)	400 ssu* (82 centistokes)	400 ssu* (82 centistokes)	400 ssu* (82 centistokes)	400 ssu* (82 centistokes)
Temperature: Sufficient heat rejection capacity to limit max. fluid temperature to: (at max. expected ambient temperature)	140° F (60° C)	140° F (60° C)	140° F (60° C)	140° F (60° C)
Min. cooling capacity at a temperature difference of between ambient and fluid temps	3 hp (2.24 kW) 40° F (22° C)	5 hp (3.73 kW) 40° F (22° C)	6 hp (5.22 kW) 40° F (22° C)	7 hp (4.47 kW) 40° F (22° C)
<b>NOTE:</b> Do not operate the tool at oil temperatures above 140° F (60° C). Operation at higher temperatures can cause operator discomfort at the tool.				
Filter Min. full-flow filtration Sized for flow of at least: (For cold temp. startup and max. dirt-holding capacity)	25 microns 30 gpm (114 lpm)	25 microns 30 gpm (114 lpm)	25 microns 30 gpm (114 lpm)	25 microns 30 gpm (114 lpm)
Hydraulic fluid Petroleum based (premium grade, anti-wear, non-conductive) Viscosity (at min. and max. operating temps)	100-400 ssu*	100-400 ssu* (20-82 centistokes)	100-400 ssu*	100-400 ssu*
<b>NOTE:</b> When choosing hydraulic fluid, the expected oil temperature extremes that will be experienced in service determine the most suitable temperature viscosity characteristics. Hydraulic fluids with a viscosity index over 140 will meet the requirements over a wide range of operating temperatures.				
*SSU = Saybolt Seconds Universal				

### EHTMA HYDRAULIC SYSTEM REQUIREMENTS

### CLASSIFICATION

Flow Range	3.5-4.3 gpm (13.5-16.5 lpm)	4.7-5.8 gpm (18-22 lpm)	7.1-8.7 gpm (27-33 lpm)	9.5-11.6 gpm (36-44 lpm)	11.8-14.5 gpm (45-55 lpm)
Nominal Operating Pressure (at the power supply outlet)	1870 psi (129 bar)	1500 psi (103 bar)	1500 psi (103 bar)	1500 psi (103 bar)	1500 psi (103 bar)
System relief valve setting (at the power supply outlet)	2495 psi (172 bar)	2000 psi (138 bar)	2000 psi (138 bar)	2000 psi (138 bar)	2000 psi (138 bar)

**NOTE:** These are general hydraulic system requirements. See tool specification page for tool specific requirements

# WRENCH TORQUE INFORMATION

## FACTORS THAT AFFECT TORQUE

An impact wrench is a rotary hammer that impacts the head of a bolt or nut. It does not apply a slow steady torque as a standard torque wrench. Therefore, several factors affect the result of torque when using impact wrenches:

1. **LONG BOLTS.** Long bolts having high-friction threads with lubrication under the bolt head or associated nut can twist when impacted, then untwist before the next impact. This will especially happen if there is low friction between the bolt head or nut and the mating surface.
2. **HEAVY, LOOSE OR MULTIPLE ADAPTERS.** Heavy, loose or multiple adapters between the wrench and socket can dissipate the intensity of the impact to the bolt head or nut.
3. **AMOUNT OF IMPACT.** Maximum torque results can be obtained by allowing continuous impacting of the socket against the bolt head or nut for at least 10 seconds.
4. **HYDRAULIC FLOW RATE.** If the flow rate to the tool is too low, the hammer (or impact) speed is reduced. If the flow is correct, a change in the relief pressure does not affect the impact force. Poorly designed hydraulic circuits can result in lower flow rates and reduced impact speeds when pressure is required during impacting.

## BOLT GRADE AND THREAD RECOMMENDATIONS

Allowable bolt torque is limited by both bolt thread diameter and grade of steel in the bolt. The IW16 Impact Wrench is recommended for use on the following bolt grade and thread sizes:

SAE Grade 2	1-1/8 to 1-7/8 inch / 28.5 / 47.6 mm
SAE Grade 5	1 to 1-5/8 inch / 25.4-41.2 mm
SAE Grade 8	7/8 to 1-3/8 inch / 22.2-35 mm

## PREOPERATION PROCEDURES

### CHECK POWER SOURCE

1. Using a calibrated flow meter and pressure gauge, check that the hydraulic power source develops a flow of 7–12 gpm / 20–45 lpm at 1000–2000 psi / 70–140 bar.
2. Make certain that the hydraulic power source is equipped with a relief valve set to open at 2100 psi/145 bar minimum.

3. Check that the hydraulic circuit matches the tool for open-center (OC) operation.
4. **UNDERWATER MODELS ONLY.** Make certain that the wrench impact mechanism is cleaned and greased with waterproof grease after each day's use.

## CONNECT HOSES

1. Wipe all hose couplers with a clean, lint-free cloth before making connections.
2. Connect hoses from the hydraulic power source to the tool fittings or quick disconnects. It is good practice to connect the return hose first and disconnect it last to minimize or eliminate trapped pressure within the wrench.
3. Observe the flow indicators stamped on the main body assembly and the hose couplers to ensure that the flow is in the proper directions. The female coupler on the tools "IN" port is the inlet (pressure) coupler.

### NOTE:

**If the uncoupled hoses are left in the sun, pressure increase within the hoses can make them difficult to connect. Whenever possible, connect the free ends of hoses together.**

## WRENCH OPERATION

The IW16 is designed for 1-inch square hex drive. The 1-inch drive configuration is used with drive sockets for high impact (500–2500 ft lb / 680–3400 Nm) installation and removal of fasteners.

During normal operation it is common to see some grease leakage from around the anvil during hard use. Refer to the *IW16 Service Manual* for the correct lubrication procedures.

Use at the low end of the 500–2500 ft lb / 680–3400 Nm torque range during continuous use over long periods of time (impact times exceeding 10 seconds). The high temperature generated in the impact mechanism can reduce steel part and lubricant durability within the wrench.

1. Observe all Safety Precautions.
2. Move the hydraulic circuit control valve to the "ON" position to operate the wrench.

# WRENCH OPERATION

## **⚠ WARNING**

Always use sockets and accessories designed for impact type applications. **DO NOT USE STANDARD SOCKETS OR ACCESSORIES. THESE CAN CRACK OR FRACTURE DURING OPERATION.**

3. Select the direction of impact desired using the reversing valve located on the side of the wrench. To select clockwise direction, place the valve in the upward position. To select counter-clockwise direction, place the valve in the downward position.

### **NOTE:**

**To more accurately tighten bolts, lubricate threads, check with a torque wrench and duplicate time of impacting for other bolts of the same length and thread size.**

4. Squeeze the trigger to activate the wrench.
5. Release the trigger to stop the wrench.

## **COLD WEATHER OPERATION**

If the wrench is to be used during cold weather, preheat the hydraulic fluid at low engine speed. When using the normally recommended fluids, fluid temperature should be at or above 50° F/10° C (400 ssu/82 centistokes) before use.

Damage to the hydraulic system or wrench can result from use with fluid that is too viscous or too thick.

## **POST OPERATION—UNDERWATER MODELS ONLY**

The wrench impact mechanism must be cleaned and greased with waterproof grease after every day of use. The main housing valve and motor are sealed and do not require maintenance unless they are malfunctioning.

Remove, clean, grease and assemble the impact mechanism as described in the *IW16 Service Manual*.

## **EXTENSION HANDLE**

If the handle and anchor block are removed, all valve handle/motor housing bolts must be cleaned, installed with 242 Loctite® and re-torqued. Contact Stanley authorized service for procedure.

## TOOL PROTECTION & CARE

### NOTICE

In addition to the Safety Precautions found in this manual, observe the following for equipment protection and care.

- Make sure all couplers are wiped clean before connection.
- The hydraulic circuit control valve must be in the “OFF” position when coupling or uncoupling hydraulic tools. Failure to do so may result in damage to the quick couplers and cause overheating of the hydraulic system.
- Always store the tool in a clean dry space, safe from damage or pilferage.
- Make sure the circuit PRESSURE hose (with male quick disconnect) is connected to the “IN” port. The circuit RETURN hose (with female quick disconnect) is connected to the opposite port. Do not reverse circuit flow. This can cause damage to internal seals.
- Always replace hoses, couplings and other parts with replacement parts recommended by Stanley Hydraulic Tools. Supply hoses must have a minimum working pressure rating of 2500 psi/172 bar.
- Do not exceed the rated flow (see Specifications) in this manual for correct flow rate and model number. Rapid failure of the internal seals may result.
- Always keep critical tool markings, such as warning stickers and tags legible.
- Tool repair should be performed by experienced personnel only.
- Make certain that the recommended relief valves are installed in the pressure side of the system.
- Do not use the tool for applications for which it was not intended.

# TROUBLESHOOTING

If symptoms of poor performance develop, the following chart can be used as a guide to correct the problem. When diagnosing faults in operation of the wrench, always check that the hydraulic power source is supplying the correct hydraulic flow and pressure to the tool as listed in the following table. Use a flow meter known to be accurate. Check the flow with the hydraulic fluid temperature at least 80 ° F/27 ° C.

PROBLEM	CAUSE	SOLUTION
Low performance or impact.	Incorrect hydraulic flow.	Check that the hydraulic power source is producing 7-12 gpm/20-45 lpm at 1500-2000 psi/105-140 bar.
	Defective quick disconnects.	Check each quick disconnect.
	Worn impact mechanism.	Repair or replace the impact mechanism. See Service Mechanism Removal Cleaning and Installation procedure to extend mechanism life.
	Hammer pins broken.	Replace with integral frame (with pins). Check relief adjustment screw setting. Job may require a larger wrench.
	Incorrect grease or periodic maintenance of the impact mechanism is not being performed.	See Service Manual.
	Spools incorrectly installed.	Valve(s) incorrectly reassembled. See Service Manual.
	Sockets or adapters too heavy or loose.	Use the correct impact type sockets or adapters.
	Long bolt with lubricated head.	Lubricate threads only.
Wrench runs too fast. Impact mechanism or screws broken.	Incorrect hydraulic flow (too high).	Check that hydraulic power source is producing 7-12 gpm/20-45 lpm at 1500-2000 psi/105-140 bar.
	Supply and return hoses reversed.	Install hoses correctly. Refer to Operation section in this manual.
	Relief sleeve or spring damaged.	Remove and replace spool assembly.
	Adjusting screw is in too far.	Adjust correctly.
Grease leaks at anvil busing, wrench warm.	Hard duty cycle and heat forces grease out.	Normal unless greasing instructions in Service Manual are not followed.
Grease leaks at anvil bushing, wrench cold.	Main shaft O-ring leaking.	Replace as required.
Oil leak at motor cap face.	Fasteners loose.	Tighten to recommended torque.
	Face O-ring worn or missing.	Replace as required.
	Motor cap/main housing damaged.	Replace as required.
Oil leaks at reversing spool.	Damaged O-rings.	Replace as required. Check Service Manual to avoid cutting O-rings on cross holes in the spool bore.
	Wrong hydraulic fluid. Circuit too hot.	Refer to Operation section for correct fluid/circuit specifications.

# SPECIFICATIONS

Drive Size .....	1-inch Square Drive
Weight .....	26 lbs/12 kg
Overall Length .....	14-1/2-inch/37 cm
Width .....	4-inch/11 cm
Pressure Range.....	1500-2000 psi/105-140 bar
Flow Range .....	7-12 gpm/20-45 lpm
Optimum Flow .....	8 gpm/30 lpm
System Type.....	Open and Closed Center, HTMA Type II or III
Porting .....	8 SAE O-ring
Output Speed (free spin) .....	2000 rpm at 5 gpm/19 lpm
Input Speed .....	1200 Impacts per Minute
Connect Size and Type .....	3/8-inch Male Pipe Adapter
Torque.....	500–2500 ft. lb/680–3400 Nm

SOUND AND VIBRATION DECLARATION	
Test conducted on IW16157, S/N 9524, operated at standard 10 gpm input	
Measured A-weighted sound power level, Lwa (ref. 1pW) in decibels	113.2 dBA
Uncertainty, Kwa, in decibels	3 dBA
Measured A-weighted sound pressure level, Lpa (ref. 20 µPa) at operator's position, in decibels	102.2 dBA
Uncertainty, Kpa, in decibels	3 dBA
Values determined according to noise test code given in ISO 15744, using the basic standard ISO 3744	
<b>NOTE:</b> The sum of a measured noise emission value and its associated uncertainty represents an upper boundary of the range of values which is likely to occur in measurements.	
Declared vibration emission value in accordance with EN 12096	
Measured vibration emission value: a	49 m/sec <sup>2</sup>
Uncertainty: K	5.2 m/sec <sup>2</sup>
Values determined according to ISO 8662-7	

# ACCESSORIES

Description	Part Number
Adapter, 1-inch to 3/4-inch Drive .....	31201
Extension, 10 inch, 1-inch Drive .....	31203
Socket Retainer Pin, 1-inch Square Drive Socket .....	33276
Socket Retainer Ring, 1-inch Square Drive Socket .....	33277

## SOCKETS

1-inch Square Drive 4-point Rectangular Head Lag Screw Socket 7/8 in. x 1-1/8 in. ....	66318
1-inch Square Drive 8-Point Deep × 1-5/16 inch .....	25203
1-inch Square Drive 8-Point Deep × 1-3/8 inch .....	25204
1-inch Square Drive 8-Point Deep × 1-1/2 inch .....	25205
1-inch Square Drive 8-Point Deep × 1-9/16 inch .....	25206
1-inch Square Drive 8-Point Deep × 1-7/8 inch .....	25208
1-inch Square Drive 8-Point Deep × 2 inch .....	25209
1-inch Square Drive 8-Point Deep × 2-1/8 inch .....	25210
1-inch Square Drive 8-Point Deep × 2-3/16 inch .....	25211
1-inch Square Drive 8-Point Deep × 2-1/4 inch .....	25212
1-inch Square Drive 8-Point Deep × 1-5/8 inch .....	25216
1-inch Square Drive 8-Point Deep × 1-13/16 inch .....	25217
1-inch Square Drive 8-Point Deep × 1-11/16 inch .....	25218
1-inch Square Drive #70 Torx .....	26456
1-inch Square Drive 8-Point Deep × 1-1/4 inch .....	26529
1-inch Square Drive 4-Point Deep × 1 inch .....	27710

## Socket Sets

Socket Set, Includes 6 Sockets .....	33230
(25211, 25216, 25217, 25218, 26456, 27710)	

Upright Handle Assy Kit.....72768  
 (Includes Upright Handle, decals, bolts, washers and Inst.)

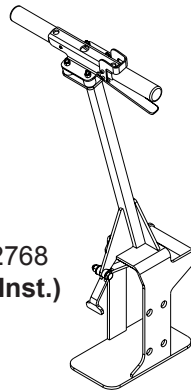



# IW16 PARTS ILLUSTRATION

CAPSCREW LOCATIONS  
ALL IW16 MODELS

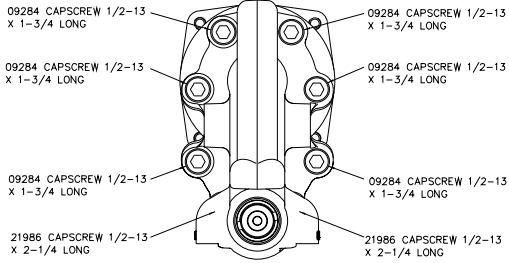
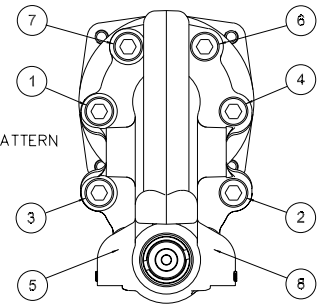

FIGURE 2

**CAUTION**

Make sure the correct cap screw is used in the correct location

TORQUE PATTERN



TORQUE TO 55 ft lb IN A CROSS PATTERN AS SHOWN ABOVE

NOTE: Item 43 See page 18 Before Ordering

TORQUE TO 55 ft lb IN A CROSS PATTERN AS SHOWN ABOVE

NOTE: IF THE TOOL IS EQUIPPED WITH HOSE WHIPS OR COUPLERS THEY CAN BE INSTALLED IN ONE OF TWO PORTS. THE PORTS FACING DOWN OR THE PORTS FACING TO THE REAR, MAKE SURE THE PLUGS (ITEM # 55) ARE INSTALLED IN THE PORTS WITHOUT THE HOSES OR COUPLERS.

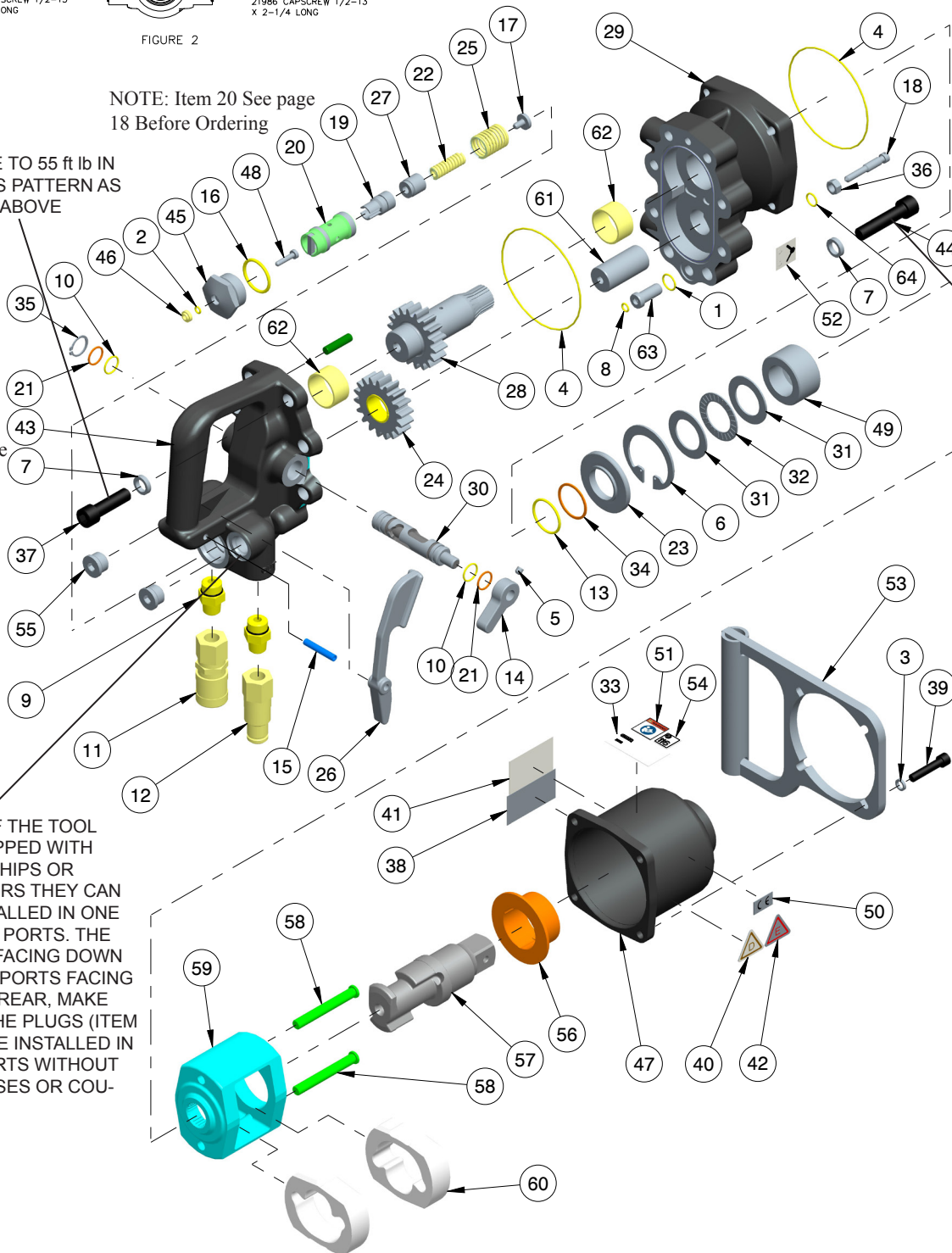

# IW16 PARTS LIST

ITEM NO.	PART NO.	QTY	DESCRIPTION
1	00016	1	O-RING*
2	00026	1	O-RING*
3	00231	4	LOCKWASHER 5/16" I.D.
4	00255	2	O-RING*
5	00580	1	SETSCREW 1/4-20 X 1/4
6	00663	1	RETAINING RING
7	00697	8	LOCKWASHER 1/2" I.D.
8	00717	1	O-RING*
9	00936	2	ADAPTER -8 (1/2) SAE X 3/8 NPT
10	01211	2	O-RING*
11	03972	1	COUPLER,3/8FEM. (SET 03971)
12	03973	1	COUPLER,3/8MALE (SET 03971)
13	04888	1	O-RING*
14	04939	1	LEVER
15	05965	1	ROLL PIN
16	06533	1	O-RING*
17	07982	1	SPRING REST
18	07984	1	RELIEF ADJUSTMENT SCREW
19	07986	1	RELIEF SEAT
20	73046	1	SPOOL (See page 18 before ordering)
21	08015	2	BACK-UP RING*
22	08122	1	COMPRESSION COIL SPRING
23	08125	1	SEAL BACK-UP WASHER*
24	08128	1	IDLER GEAR ASSY
25	08131	1	COMPRESSION COIL SPRING
26	08133	1	TRIGGER
27	08135	1	RELIEF POPPET
28	08136	1	MAIN SHAFT
29	08137	1	MOTOR HOUSING ASSY (INCLUDES ITEMS 61 THRU 64)
30	08139	1	REVERSING SPOOL
31	08147	2	THRUST WASHER
32	08148	1	THRUST BEARING
33	08153	1	NAME TAG - IW16
34	08180	1	BACK-UP RING*
35	09275	1	RETAINING RING EXTERNAL
36	09277	1	HEX NUT 5/16-18UNC
37	09284	6	HSCHS 1/2-13 X 1-3/4
38	09612	1	GENERAL CAUTION STICKER
39	09625	4	HSCHS 5/16-18 X 1-1/2
40	11207	1	CIRCUIT TYPE "D" STICKER
41	12412	1	DANGER STICKER - ELECTRICAL
42	12535	1	CIRCUIT TYPE "E" STICKER

ITEM NO.	PART NO.	QTY	DESCRIPTION
43	73167	1	VALVE HANDLE ASSY (INCLUDES ITEMS 55 and 62). SEE PAGE #18 BEFORE ORDERING
44	21986	2	HSCHS 1/2-13 X 2-1/4
45	22063	1	SPOOL CAP
46	22064	1	ROD WIPER*
47	24682	1	HAMMER CASE, LAND (INCL ITEM 56)
	24758	1	HAMMER CASE U/W MODIFIED (INCL BUSHING72762)
48	23678	1	HEADED PUSH PIN
49	23817	1	THRUST SPACER
50	28323_	1	1 CE STICKER
51	28788	1	STICKER - MANUAL
52	30136	1	ROTATION DIRECTION STICKER
53	32087	1	ASSIST HANDLE
54	66305	1	GUARANTEED SOUND POWER LEVEL 116 dBA
55	350237	2	HOLLOW HEX PLUG - 8 SAE
56	21010	1	BUSHING
	21011	1	BUSHING (UNDERWATER)
57	24678	1	ANVIL
58	24680	2	HAMMER PINS
59	24679	1	HAMMER FRAME (INCLUDES ITEM 58 PINS)
	72840	1	HAMMER FRAME ONLY
60	24677	2	HAMMER
61	08123	1	IDLER SHAFT
62	08146	2	BUSHING
63	07995	1	INSERT
64	03252	1	O-RING
	23134	1	STANDARD MECHANISM ASSY (INCL ITEMS 47, & 56 THRU 60)
	24757		UNDERWATER MECHANISM (INCL ITEMS 47 & 56 THRU 60)
	56725	2	HOSE ASSY for IW16150S (NOT PICTURED)
	66727	2	HOSE ASSY for IW16150BN (NOT PICTURED)
	47438	1	COUPLER SET FOR IW16150BN

**SEAL KIT (P/N-09602)**

**\* DENOTES PART IN SEAL KIT**

# VALVE HANDLE CHANGE NOTICE

## ALL IW16 IMPACT WRENCH MODELS Notification of change in valve handle assembly and on/off spool. Part numbers and compatibility (March 2013).

Beginning at serial number 031513001, the valve handle assembly has changed. The prior style (part # 17279) used a steel spool sleeve installed in the valve handle assembly. The new style valve handle assembly (part # 73167) does not use a spool sleeve.

New style valve spool assembly (part # 73046) is required for use in the new style valve handle assembly.

The new style valve handle assembly will only accept new style on/off spool (PN 73046). If replacing old style 17279 valve handle assembly with new style 73167, replacement of 73046 valve spool is also required. New style on/off spool 73046 will fit old style and new style valve handle assemblies. Old style valve spool P/N 07998 is no longer available and substitutes to new style 73046.

Please refer to the photos below of the old style and new style valve handle and on/off spools.

**Old Style – No Longer Available**



**New Style – Uses no sleeve in spool bore.**



Please contact the Technical Service Department at 503-659-5660 with any questions.

# IW16 UPRIGHT HANDLE PARTS

## IW16 UPRIGHT HANDLE KIT P/N-72768

ITEM	P/N	QTY	DESCRIPTION
1	10792	2	BOLT 5/8-11 x 1-1/4
2	25610	1	RAILROAD HELPDESK STICKER
3	30136	1	DIRECTION STICKER
4	66037	1	UPRIGHT HANDLE W/TRIGGER LOCK
5	371071	2	LOCKWASHER 5/8 PLATED
6	72769	1	INST FOR P/N 72768
7	66035	4	ISOLATOR
8	31030	2	HANDLE GRIP

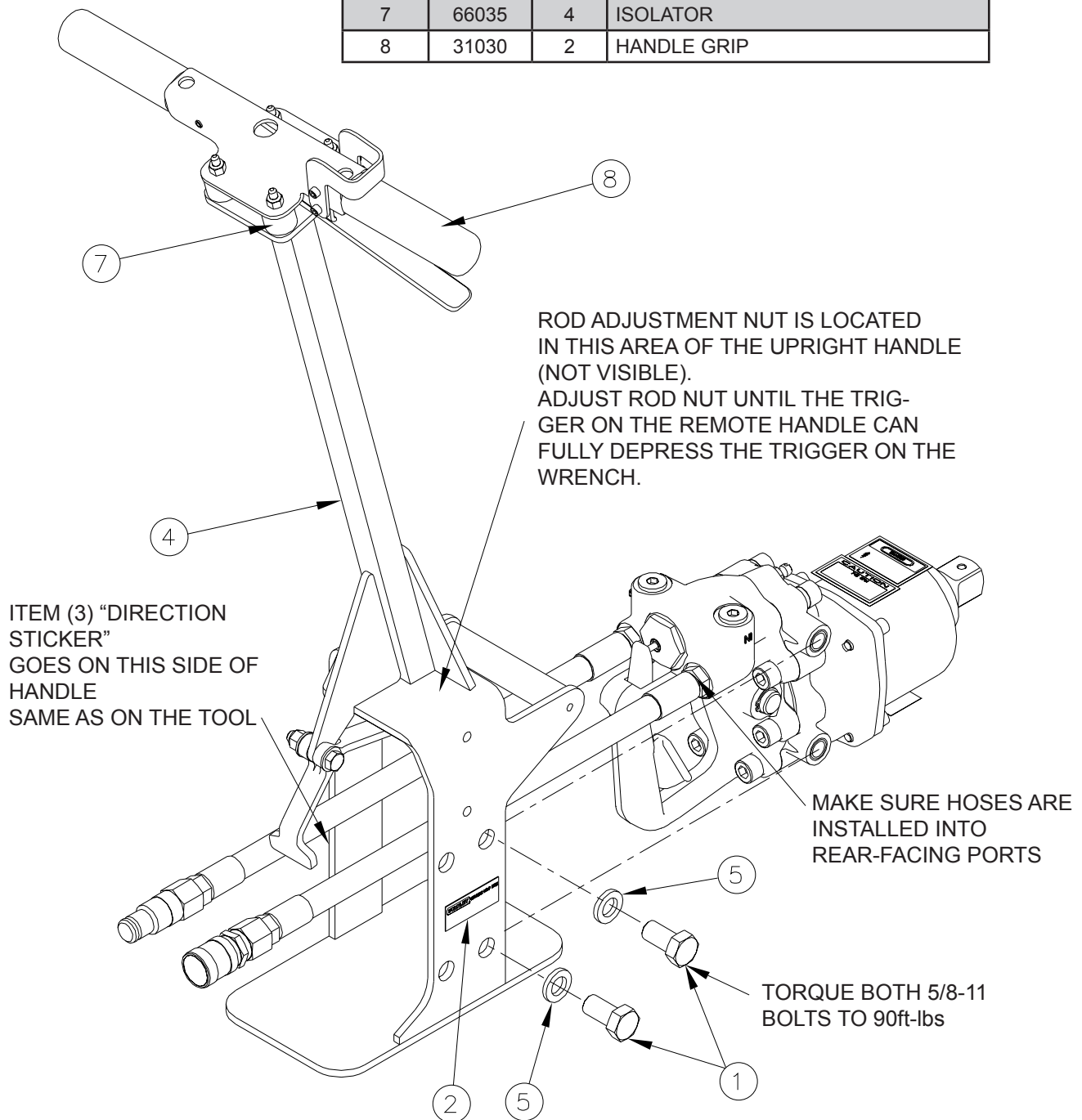

# UNDERWATER TOOLS DEPTH GUIDELINE

## UNDERWATER MODELS ONLY

### **⚠ CAUTION**

**DO NOT USE HYDRAULIC TOOLS UNDERWATER THAT ARE NOT DESIGNATED AS AN “UNDERWATER” MODEL, OR THIS WILL RESULT IN DAMAGE TO THE TOOL.**

For underwater hydraulic tools the applications are broken down into four quadrants depending on type of tool and method of operation.

The types of tools are percussive and rotational, each with different characteristics allowing for different depth operation. With percussive tools, the nitrogen accumulator PSI must counter the increase in ambient pressure found at lower depths. Since there is a maximum PSI for percussive tools they are limited to certain depths. Rotational tools do not have accumulators and thus capable of deeper depths.

The methods are broken into diver operated or remote operated vehicle (ROV). ROV's can reach lower depths and with an on-board hydraulic power source that is depth compensated, can operate hydraulic tools at depths of thousands of feet. ROV operation is still limited to the tool, for example a percussive tool has the same depth limitation whether ROV or diver operated.



## Operation Overview

	Percussive	Rotational
Diver	Tools: Breakers, Hammer Drills and Chipping Hammers  Max Depth: 500' - limitations due to accumulator PSI max (increase 40 PSI for every 100')	Tools: Grinders, Saws, Chain Saws  Max Depth: 1000' - Reference hose sizing guide below
ROV	Tools: Breakers, Hammer Drills and Chipping Hammers  Max Depth: 500' - limitations due to accumulator PSI max (increase 40 PSI for every 100')	Tools: Grinders, Saws, Chain Saws  Max Depth: 1000' - Reference hose sizing guide below

## Recommended Hose Diameters

Depth (ft)	8 GPM	12 GPM
100	5/8"	5/8"
300	3/4"	1"
600	1"	1"
1000	1"	1-1/4"





# **STANLEY®**

Stanley Hydraulic Tools  
3810 SE Naef Road  
Milwaukie, Oregon 97267-5698 USA  
(503) 659-5660 / Fax (503) 652-1780  
[www.stanleyhydraulics.com](http://www.stanleyhydraulics.com)