

# STANLEY®

## PP10 HYDRAULIC POST PULLER



### USER MANUAL Safety, Operation and Maintenance



© 2014 Stanley Black & Decker, Inc.  
New Britain, CT 06053  
U.S.A.  
59020 9/2014 Ver. 7



# TABLE OF CONTENTS

SAFETY SYMBOLS .....	4
SAFETY PRECAUTIONS.....	5
TOOL STICKERS & TAGS .....	6
HOSE TYPES.....	7
HOSE RECOMMENDATIONS .....	8
FIGURE 1. TYPICAL HOSE CONNECTIONS .....	8
HTMA REQUIREMENTS.....	9
OPERATION.....	10
TOOL PROTECTION & CARE .....	11
TROUBLESHOOTING .....	12
SPECIFICATIONS.....	13
ACCESSORIES.....	13
PP10 PARTS ILLUSTRATION.....	14
PP10 PARTS LIST.....	15

## IMPORTANT

To fill out a Product Warranty Validation form, and for information on your warranty, visit [Stanleyhydraulics.com](http://Stanleyhydraulics.com) and select the Company tab, Warranty.  
(NOTE: The warranty Validation record must be submitted to validate the warranty).

**SERVICING:** This manual contains safety, operation, and routine maintenance instructions. Stanley Hydraulic Tools recommends that servicing of hydraulic tools, other than routine maintenance, must be performed by an authorized and certified dealer. Please read the following warning.

## ⚠ WARNING

**SERIOUS INJURY OR DEATH COULD RESULT FROM THE IMPROPER REPAIR OR SERVICE OF THIS TOOL.**

**REPAIRS AND / OR SERVICE TO THIS TOOL MUST ONLY BE DONE BY AN AUTHORIZED AND CERTIFIED DEALER.**

For the nearest authorized and certified dealer, call Stanley Hydraulic Tools at the number listed on the back of this manual and ask for a Customer Service Representative.



# SAFETY PRECAUTIONS

Tool operators and maintenance personnel must always comply with the safety precautions given in this manual and on the stickers and tags attached to the tool and hose.

These safety precautions are given for your safety. Review them carefully before operating the tool and before performing general maintenance or repairs.

Supervising personnel should develop additional precautions relating to the specific work area and local safety regulations. If so, place the added precautions in the space provided in this manual.

The models PP10 Hydraulic Post Puller will provide safe and dependable service if operated in accordance with the instructions given in this manual. Read and understand this manual and any stickers and tags attached to the PP10 before operation. Failure to do so could result in personal injury or equipment damage.



- Operator must start in a work area without bystanders. The operator must be familiar with all prohibited work areas such as excessive slopes and dangerous terrain conditions.
- Establish a training program for all operators to ensure safe operation.
- Do not operate the tool unless thoroughly trained or under the supervision of an instructor.
- Always wear safety equipment such as goggles, ear and head protection, and safety shoes at all times when operating the tool.
- Do not inspect or clean the tool while the hydraulic power source is connected. Accidental engagement of the tool can cause serious injury.
- Always connect hoses to the tool hose couplers before energizing the hydraulic power source. Be sure all hose connections are tight.
- Do not operate the tool at oil temperatures above 140 °F/60 °C. Operation at higher temperatures can cause higher than normal temperatures at the tool which can result in operator discomfort.

- Do not operate a damaged, improperly adjusted, or incompletely assembled tool.
- Stay clear of all moving parts.
- Never wear loose clothing that can get entangled in the working parts of the tool.
- To avoid personal injury or equipment damage, all tool repair, maintenance and service must only be performed by authorized and properly trained personnel.
- System pressure hose must always be connected to the tool **IN** or “P” port and system return hose must be connected to the tool **OUT** or “T” port. Reversing connections or reversing flow to the tool can result in severe personal injury.
- Never use tools near energized transmission lines. Know the location of buried or covered services before starting your work.
- Do not overreach. Maintain proper footing and balance at all times.

# TOOL STICKERS & TAGS

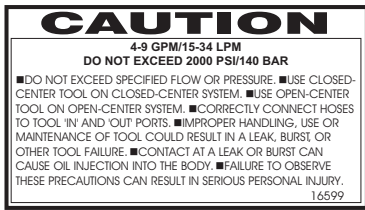

16599  
GPM Sticker 4–9 2000 Psi



05152  
Logo/Address Decal



17572  
Pinch Point Warning Sticker



35210  
Warning Sticker

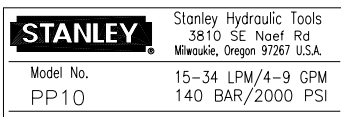

17573  
PP10 Name Tag

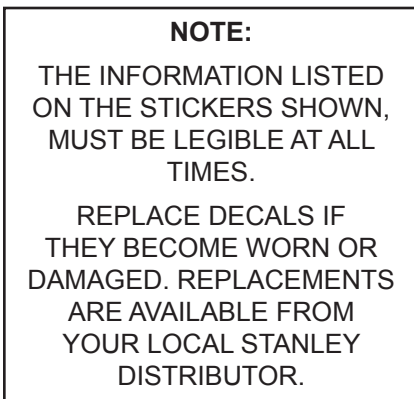

The safety tag (P/N 15875) at right is attached to the tool when shipped from the factory. Read and understand the safety instructions listed on this tag before removal. We suggest you retain this tag and attach it to the tool when not in use.

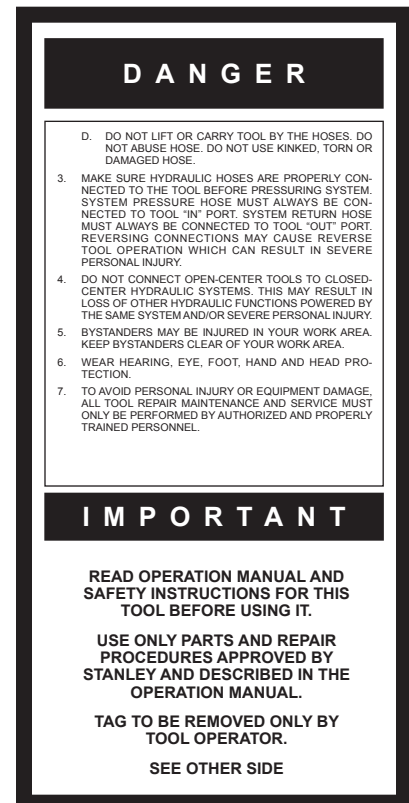
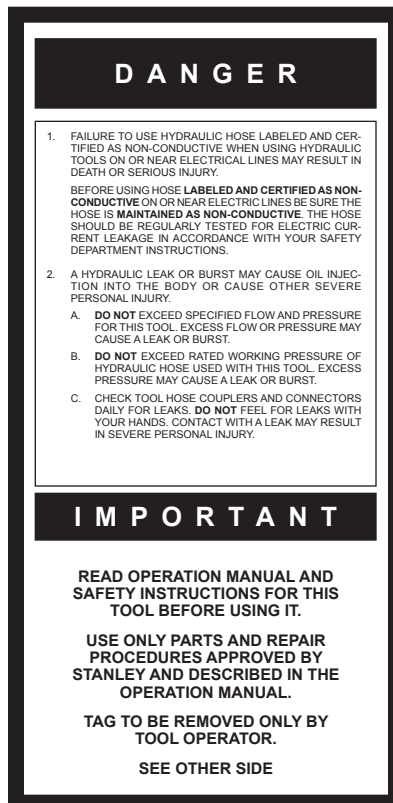

SAFETY TAG P/N 15875 (Shown smaller than actual size)

# HOSE TYPES

The rated working pressure of the hydraulic hose must be equal to or higher than the relief valve setting on the hydraulic system. There are three types of hydraulic hose that meet this requirement and are authorized for use with Stanley Hydraulic Tools. They are:

**Certified non-conductive** — constructed of thermoplastic or synthetic rubber inner tube, synthetic fiber braid reinforcement, and weather resistant thermoplastic or synthetic rubber cover. *Hose labeled **certified non-conductive** is the only hose authorized for use near electrical conductors.*

**Wire-braided** (conductive) — constructed of synthetic rubber inner tube, single or double wire braid reinforcement, and weather resistant synthetic rubber cover. *This hose is **conductive** and must never be used near electrical conductors.*

**Fabric-braided** (not certified or labeled non-conductive) — constructed of thermoplastic or synthetic rubber inner tube, synthetic fiber braid reinforcement, and weather resistant thermoplastic or synthetic rubber cover. *This hose is **not certified non-conductive** and must never be used near electrical conductors.*

## HOSE SAFETY TAGS

To help ensure your safety, the following DANGER tags are attached to all hose purchased from Stanley Hydraulic Tools. **DO NOT REMOVE THESE TAGS.**

If the information on a tag is illegible because of wear or damage, replace the tag immediately. A new tag may be obtained from your Stanley Distributor.

### THE TAG SHOWN BELOW IS ATTACHED TO “CERTIFIED NON-CONDUCTIVE” HOSE

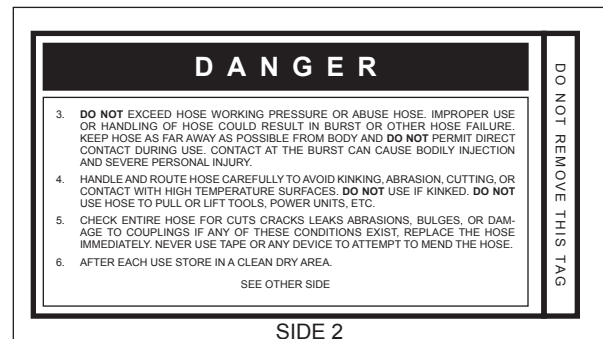
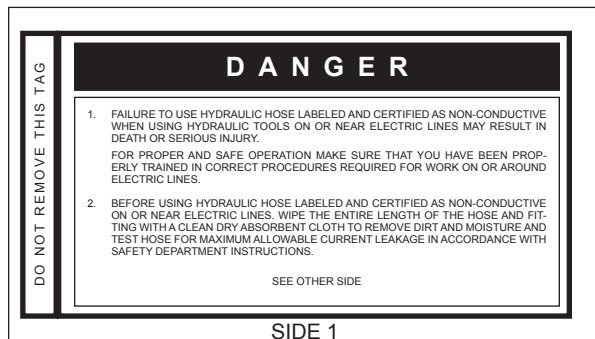

(Shown smaller than actual size)

### THE TAG SHOWN BELOW IS ATTACHED TO “CONDUCTIVE” HOSE.

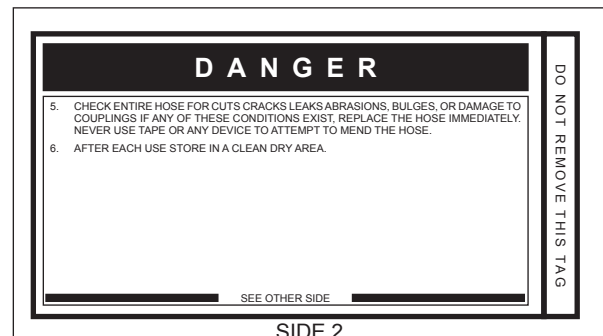
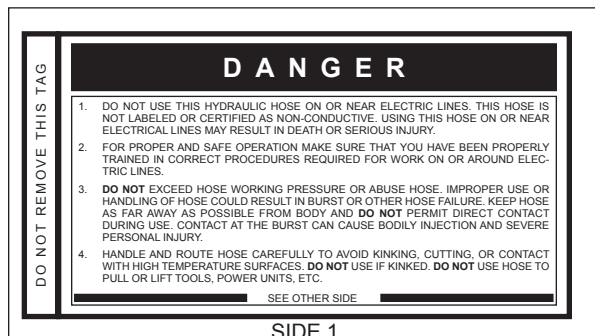

(Shown smaller than actual size)

# HOSE RECOMMENDATIONS

## Tool to Hydraulic Circuit Hose Recommendations

The chart to the right shows recommended minimum hose diameters for various hose lengths based on gallons per minute (gpm)/liters per minute (lpm). These recommendations are intended to keep return line pressure (back pressure) to a minimum acceptable level to ensure maximum tool performance.

This chart is intended to be used for hydraulic tool applications only based on Stanley Hydraulic Tools tool operating requirements and should not be used for any other applications.

All hydraulic hose must have at least a rated minimum working pressure equal to the maximum hydraulic system relief valve setting.

**All hydraulic hose must meet or exceed specifications as set forth by SAE J517.**

Oil Flow		Hose Lengths		Inside Diameter		USE (Press/Return)	Min. Working Pressure	
GPM	LPM	FEET	METERS	INCH	MM		PSI	BAR
<b>Certified Non-Conductive Hose - Fiber Braid - for Utility Bucket Trucks</b>								
4-9	15-34	up to 10	up to 3	3/8	10	Both	2250	155
<b>Conductive Hose - Wire Braid or Fiber Braid -DO NOT USE NEAR ELECTRICAL CONDUCTORS</b>								
4-6	15-23	up to 25	up to 7.5	3/8	10	Both	2500	175
4-6	15-23	26-100	7.5-30	1/2	13	Both	2500	175
5-10.5	19-40	up to 50	up to 15	1/2	13	Both	2500	175
5-10.5	19-40	51-100	15-30	5/8	16	Both	2500	175
5-10.5	19-40	100-300	30-90	5/8	16	Pressure	2500	175
10-13	38-49	up to 50	up to 15	3/4	19	Return	2500	175
10-13	38-49	51-100	15-30	5/8	16	Both	2500	175
10-13	38-49	100-200	30-60	3/4	19	Pressure	2500	175
13-16	49-60	up to 25	up to 8	1	25.4	Return	2500	175
13-16	49-60	26-100	8-30	5/8	16	Pressure	2500	175
				3/4	19	Return	2500	175
				1	25.4	Return	2500	175

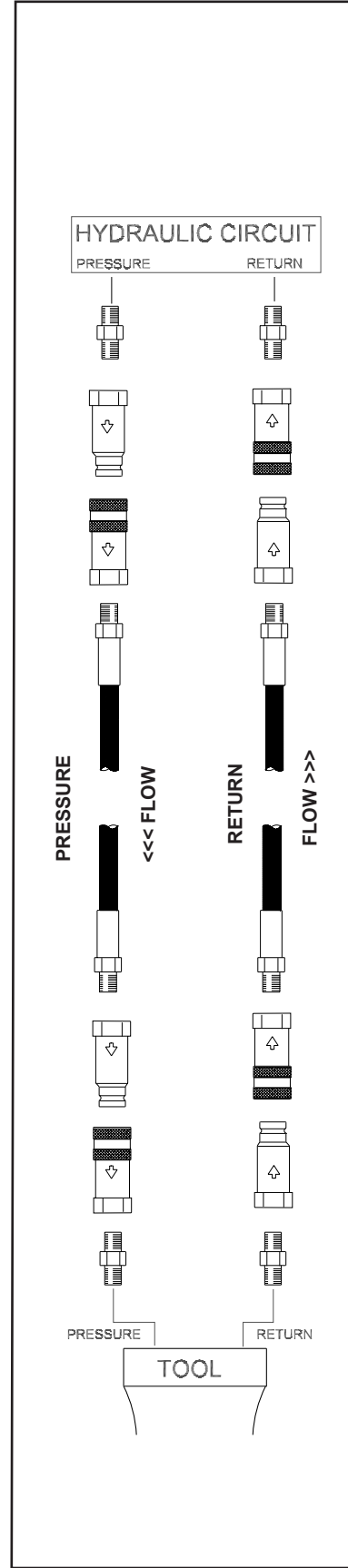

Figure 1. Typical Hose Connections



# HTMA / EHTMA REQUIREMENTS

## HTMA

### HYDRAULIC SYSTEM REQUIREMENTS

### TOOL TYPE

#### TYPE I

#### TYPE II

#### TYPE RR

#### TYPE III

Flow Range	4-6 gpm (15-23 lpm)	7-9 gpm (26-34 lpm)	9-10.5 gpm (34-40 lpm)	11-13 gpm (42-49 lpm)
Nominal Operating Pressure (at the power supply outlet)	1500 psi (103 bar)	1500 psi (103 bar)	1500 psi (103 bar)	1500 psi (103 bar)
System relief valve setting (at the power supply outlet)	2100-2250 psi (145-155 bar)	2100-2250 psi (145-155 bar)	2200-2300 psi (152-159 bar)	2100-2250 psi (145-155 bar)
Maximum back pressure (at tool end of the return hose)	250 psi (17 bar)	250 psi (17 bar)	250 psi (17 bar)	250 psi (17 bar)
Measured at a max. fluid viscosity of: (at min. operating temperature)	400 ssu* (82 centistokes)	400 ssu* (82 centistokes)	400 ssu* (82 centistokes)	400 ssu* (82 centistokes)
Temperature: Sufficient heat rejection capacity to limit max. fluid temperature to: (at max. expected ambient temperature)	140° F (60° C)	140° F (60° C)	140° F (60° C)	140° F (60° C)
Min. cooling capacity at a temperature difference of between ambient and fluid temps	3 hp (2.24 kW) 40° F (22° C)	5 hp (3.73 kW) 40° F (22° C)	6 hp (5.22 kW) 40° F (22° C)	7 hp (4.47 kW) 40° F (22° C)
<b>NOTE:</b> Do not operate the tool at oil temperatures above 140° F (60° C). Operation at higher temperatures can cause operator discomfort at the tool.				
Filter Min. full-flow filtration Sized for flow of at least: (For cold temp. startup and max. dirt-holding capacity)	25 microns 30 gpm (114 lpm)	25 microns 30 gpm (114 lpm)	25 microns 30 gpm (114 lpm)	25 microns 30 gpm (114 lpm)
Hydraulic fluid Petroleum based (premium grade, anti-wear, non-conductive) Viscosity (at min. and max. operating temps)	100-400 ssu*	100-400 ssu* (20-82 centistokes)	100-400 ssu*	100-400 ssu*
<b>NOTE:</b> When choosing hydraulic fluid, the expected oil temperature extremes that will be experienced in service determine the most suitable temperature viscosity characteristics. Hydraulic fluids with a viscosity index over 140 will meet the requirements over a wide range of operating temperatures.				
*SSU = Saybolt Seconds Universal				

## EHTMA HYDRAULIC SYSTEM REQUIREMENTS

### CLASSIFICATION

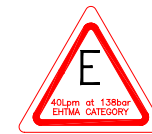

Flow Range	3.5-4.3 gpm (13.5-16.5 lpm)	4.7-5.8 gpm (18-22 lpm)	7.1-8.7 gpm (27-33 lpm)	9.5-11.6 gpm (36-44 lpm)	11.8-14.5 gpm (45-55 lpm)
Nominal Operating Pressure (at the power supply outlet)	1870 psi (129 bar)	1500 psi (103 bar)	1500 psi (103 bar)	1500 psi (103 bar)	1500 psi (103 bar)
System relief valve setting (at the power supply outlet)	2495 psi (172 bar)	2000 psi (138 bar)	2000 psi (138 bar)	2000 psi (138 bar)	2000 psi (138 bar)

**NOTE:** These are general hydraulic system requirements. See tool specification page for tool specific requirements

# OPERATION

## PRE-OPERATION PROCEDURES

### CHECK HYDRAULIC POWER SOURCE

1. Using a calibrated flowmeter and pressure gauge, check that the hydraulic power source develops a flow of 3–9 gpm/11–34 lpm at 2000 psi/140 bar.
2. Make certain the hydraulic power source is equipped with a relief valve set to open at 2100–2250 psi/145–155 bar minimum.

### CHECK TOOL

1. There should be no signs of leaks.
2. The tool should be clean, with all fittings and fasteners tight.

### CONNECT HOSES

1. Wipe all hose couplers with a clean lint-free cloth before making connections.
2. Connect the hoses from the hydraulic power source to the tool fittings or quick disconnects. It is a good practice to connect the return hose first and disconnect it last to minimize or avoid trapped pressure within the tool.
3. Observe flow indicators stamped on hose couplers to be sure that oil will flow in the proper direction. The female coupler is the inlet coupler.

#### NOTE:

**The pressure increase in uncoupled hoses left in the sun may result in making them difficult to connect. When possible, connect the free ends of operating hoses together.**

4. Observe all safety precautions.
5. Move the hydraulic circuit control valve to the **ON** position to operate the tool.

## TOOL OPERATION

1. Observe all safety precautions.
2. For flanged posts, position the base weldment on a flat surface with the post engaged in the jaws of the tool.
3. For solid or square posts, position the base weldment on a flat surface and wrap a chain around the post. Place the chain in the slots on the post puller frame.
4. Actuate the control lever from the **NEUTRAL** position to the **UP** position until the post raises approximately eight inches.
5. Move the control lever from the **UP** position past the **NEUTRAL** position to the **DOWN** position. This releases the jaws (or chain) from the post and lowers the lift frame weldment down to the base weldment (bottom of post).
6. Repeat Steps one through five until the post is fully removed.

## COLD WEATHER OPERATION

If the post puller is to be used during cold weather, pre-heat the hydraulic fluid at low engine speed. When using the normally recommended fluids, fluid temperature should be at or above 50 °F/10°C (400 ssu/82 centistokes) before use.

Damage to the hydraulic system or post puller can result from use with fluid that is too viscous or thick.

# TOOL PROTECTION & CARE

## NOTICE

In addition to the Safety Precautions found in this manual, observe the following for equipment protection and care.

- Make sure all couplers are wiped clean before connection. Use only lint-free cloths.
- The hydraulic circuit control valve must be in the **OFF** position when coupling or uncoupling hydraulic tools. Failure to do so may result in damage to the quick couplers and cause overheating of the hydraulic system.
- Always store the tool in a clean dry space, safe from damage or pilferage.
- Always replace hoses, couplings and other parts with replacement parts recommended by Stanley Hydraulic Tools. Supply hoses to the intensifier must have a minimum working pressure rating of 2500 psi/175 bar.
- All hoses must have an oil resistant inner surface and an abrasion resistant outer surface. Whenever near electrical conductors, use clean hoses labeled and certified non-conductive.
- Always keep critical tool markings, such as warning stickers and tags legible.
- Do not exceed the rated limits or use the tool for applications beyond its design capacity.
- Tool repair should be performed by experienced personnel only.
- Never connect or disconnect couplers or port connections with hydraulic pressure in the hose.
- Make certain that the recommended relief valves are installed in the pressure side of the system.
- Always check high-pressure couplers for leaks and damage before operating the system at maximum rated pressure.
- Check fastener tightness often and before each use daily.

# TROUBLESHOOTING

If symptoms of poor performance develop, the following chart can be used as a guide to correct the problem.

When diagnosing faults in operation of the Post Puller, always check that the hydraulic power source is supplying the correct hydraulic flow and pressure to the post puller as listed in the table. Use a flowmeter known to be accurate. Check the flow with the hydraulic oil temperature at least 80 °F/27 °C.

PROBLEM	CAUSE	SOLUTION
Post puller does not run.	Power unit not functioning.	Check power unit for proper flow and pressure (3–9 gpm/11–34 lpm, 2000 psi/140 bar).
	Coupler or hoses blocked.	Remove restriction.
	Mechanical failure of lift cylinder assembly.	Disassemble post puller and inspect for damaged parts.
Post puller does not pull effectively.	Power unit not functioning.	Check power unit for proper pressure (2000 psi/140 bar).
	Couplers or hoses blocked.	Remove restriction.
Post puller operates slow.	Low gpm supply from power unit.	Check power source for proper flow (3–9 gpm/11–34 lpm).
	Coupler or hoses blocked.	Remove restriction.
	Relief valve set too low.	Adjust relief valve to 2100–2250 psi/145–155 bar.
Post puller gets hot.	Hot fluid going through tool.	Check power unit. Make sure the flow rate is not too high causing part of the fluid to go through the relief valve. Provide cooler to maintain proper fluid temperature (140 °F/60 °C max). Check relief valve setting.
		Eliminate flow control devices.

# SPECIFICATIONS

Capacity (Lift per Stroke).....	8 in./20 cm
Pulling Force.....	9800 lbs/4450 kg
Weight .....	70 lbs/31.8 kg
Flow Range .....	3–9 gpm/11–34 lpm
Pressure Range.....	2000 psi/140 bar
Porting .....	3/8 NPT Female Pipe Thread
Connect Size .....	90° Elbow 3/8 NPTM
Height (Retracted) .....	18-3/4 in/48 cm
Length.....	12 3/4 in/32 cm
Width .....	14 in/35.5 cm
System Type.....	Open Center

**NOTE:**

**Weights, dimensions, and operating specifications listed are subject to change without notice. Where specifications are critical to your application, please consult the factory.**

## ACCESSORIES

Chain Assembly.....	17529
---------------------	-------

# PP10 PARTS ILLUSTRATION

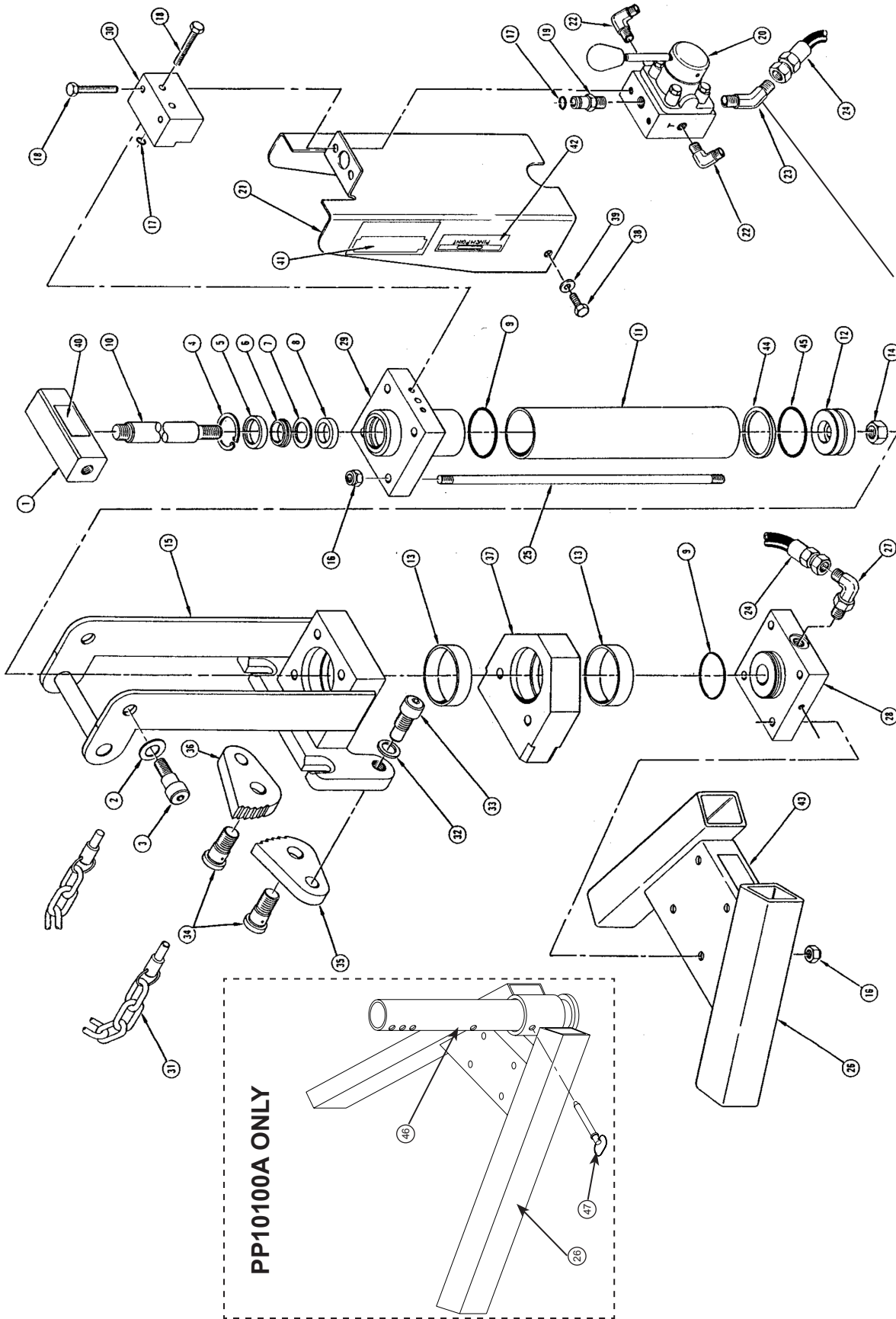

NOTE: Item # 23 has changed from a 45° elbow to a straight Adapter P/N-00946 in November 2011.

# PP10 PARTS LIST

ITEM	PART NO.	QTY	DESCRIPTION
1	17533	1	T-BAR
2	04985	2	SPRING WASHER
3	17553	2	SHOULDER SCREW, 3/4 x 3/4 HEX SOCKET HEAD
4	00166	1	RETAINING RING, 1.850 HEAVY DUTY (INTERNAL)
5	17526	1	SEAL RETAINER
6	03127	1	ROD WIPER *
7	09642	1	WASHER
8	09647	1	ROD SEAL *
9	09790	2	O-RING, 2-1/4 x 2-1/2 x 1/8 *
10	17546	1	PISTON ROD
11	17536	1	CYLINDER
12	17552	1	PISTON
13	17554	2	WEAR RING *
14	04984	1	ELASTIC STOP NUT, 3/4-16 HEX
15	17550	1	LIFT FRAME WELDMENT
16	371500	8	ELASTIC STOP NUT, 1/2-13 HEX
17	01751	2	O-RING 3/8 x 9/16 x 3/32 *
18	06736	4	CAPSCREW, 5/16-18 x 2-1/4 HEX HEAD
19	01752	1	ADAPTER FITTING
20	35518	1	VALVE ASSEMBLY
21	18514	1	GUARD WELDMENT
22	35213	2	SWIVEL, HYDRAULIC INC #956P6-P6
23	00946	1	ADAPTER 3/8 NPT MALE/3/8 TUBE
24	72801	1	HOSE ASSEMBLY (SEE NOTE 1)
25	17537	4	TIE ROD
26	17538	1	BASE WELDMENT
	35134	1	BASE WELDMENT (PP10100A ONLY)
27	01532	1	ELBOW, 90°-6 SAE/-6 TUBE
28	17545	1	CYLINDER BASE
29	17549	1	CYLINDER BEARING
30	17544	1	ADAPTER BLOCK
31	17529	1	CHAIN ASSY (ACCESSORY ITEM)
32	17559	2	WASHER, 7/8 NARROW TYPE B
33	17534	2	MODIFIED CAPSCREW
34	17540	2	SHOULDER SCREW
35	17543	1	JAW, RH (PP10100)
	33452	1	JAW, RH (PP10100A)
36	17542	1	JAW, LH (PP10100)
	33453	1	JAW, LH (PP10100A)
37	17541	1	PIVOT BLOCK
38	00569	2	CAPSCREW, 5/16-18 x 1 HEX HD
39	03031	2	LOCKWASHER, 5/16
40	16599	1	GPM STICKER

ITEM	PART NO.	QTY	DESCRIPTION
41	05152	2	STANLEY STICKER
42	17572	2	PINCH POINT WARNING STICKER
43	17573	1	NAME TAG
44	19220	1	TFE RING *
45	19221	1	O-RING *
46	35149	1	POST (PP10100A ONLY)
47	35212	1	HITCH PIN ASSY (PP10100A ONLY)
	03971	1	COUPLER SET (NOT SHOWN)
	35210	1	WARNING DECAL (NOT SHOWN)
	02324	1	CAP & PLUG, 1/2 (PP10100D ONLY)
	03288	1	CAP & PLUG 3/8 (PP10100D ONLY)
	19219	1	SEAL KIT (* DENOTES PART IN KIT)

## NOTE 1:

If you have an older PP10 built prior to November 2011 and you are replacing item # 24 Hose Assembly you will also need to replace item # 23 Adapter. There is a Hose Assy Service Kit (P/N-72802) available that includes the Hose Assy 72801 and adapter 00946. The Hose Assy 17558 is no longer available.

# **STANLEY®**

Stanley Hydraulic Tools  
3810 SE Naef Road  
Milwaukie, Oregon 97267-5698 USA  
(503) 659-5660 / Fax (503) 652-1780  
[www.stanleyhydraulics.com](http://www.stanleyhydraulics.com)