

STANLEY®

PR41 HYDRAULIC PRUNER



USER MANUAL Safety, Operation and Maintenance



© 2014 Stanley Black & Decker, Inc.
New Britain, CT 06053
U.S.A.
32472 1/2015 Ver. 6

TABLE OF CONTENTS

SAFETY SYMBOLS	4
SAFETY PRECAUTIONS	5
ELECTRICAL HAZARDS	6
TOOL STICKERS & TAGS	8
HOSE TYPES	9
HOSE RECOMMENDATIONS	10
FIGURE 1. TYPICAL HOSE CONNECTIONS	10
HTMA REQUIREMENTS	11
OPERATION	12
FIGURE 2. EXAMPLE OF LATERAL BRANCH CUT	13
FIGURE 3. EXAMPLE OF FINAL CUT	13
TOOL PROTECTION & CARE	14
TROUBLESHOOTING	15
SPECIFICATIONS	16
ACCESSORIES	16
PR41 PARTS ILLUSTRATION	17
PR41 PARTS LIST	18

IMPORTANT

To fill out a Product Warranty Validation form, and for information on your warranty, visit Stanleyhydraulics.com and select the Company tab, Warranty.
(NOTE: The warranty Validation record must be submitted to validate the warranty).

SERVICING: This manual contains safety, operation, and routine maintenance instructions. Stanley Hydraulic Tools recommends that servicing of hydraulic tools, other than routine maintenance, must be performed by an authorized and certified dealer. Please read the following warning.

⚠ WARNING

SERIOUS INJURY OR DEATH COULD RESULT FROM THE IMPROPER REPAIR OR SERVICE OF THIS TOOL.

REPAIRS AND / OR SERVICE TO THIS TOOL MUST ONLY BE DONE BY AN AUTHORIZED AND CERTIFIED DEALER.

For the nearest authorized and certified dealer, call Stanley Hydraulic Tools at the number listed on the back of this manual and ask for a Customer Service Representative.

SAFETY SYMBOLS

Safety symbols and signal words, as shown below, are used to emphasize all operator, maintenance and repair actions which, if not strictly followed, could result in a life-threatening situation, bodily injury or damage to equipment.



This is the safety alert symbol. It is used to alert you to potential personal injury hazards. Obey all safety messages that follow this symbol to avoid possible injury or death.



This safety alert and signal word indicate an imminently hazardous situation which, if not avoided, will result in death or serious injury.



This safety alert and signal word indicate a potentially hazardous situation which, if not avoided, could result in death or serious injury.



This safety alert and signal word indicate a potentially hazardous situation which, if not avoided, could result in death or serious injury.



This signal word indicates a potentially hazardous situation which, if not avoided, may result in property damage.



This signal word indicates a situation which, if not avoided, will result in damage to the equipment.

This signal word indicates a situation which, if not avoided, may result in damage to the equipment.

Always observe safety symbols. They are included for your safety and for the protection of the tool.

LOCAL SAFETY REGULATIONS

Enter any local safety regulations here. Keep these instructions in an area accessible to the operator and maintenance personnel.

SAFETY PRECAUTIONS

Tool operators and maintenance personnel must always comply with the safety precautions given in this manual and on the stickers and tags attached to the tool and hose.

These safety precautions are given for your safety. Review them carefully before operating the tool and before performing general maintenance or repairs.

Supervising personnel should develop additional precautions relating to the specific work area and local safety regulations. If so, place the added precautions in the space provided in this manual.

The PR41 Hydraulic Pruner will provide safe and dependable service if operated in accordance with the instructions given in this manual. Read and understand this manual and any stickers and tags attached to the pruner and hoses before operation. Failure to do so could result in personal injury or equipment damage.



- Operator must start in a work area without bystanders. The operator must be familiar with all prohibited work areas such as excessive slopes and dangerous terrain conditions.
- Establish a training program for all operators to ensure safe operation.
- Do not operate the tool unless thoroughly trained or under the supervision of an instructor.
- Always wear safety equipment such as goggles, ear and head protection, and safety shoes at all times when operating the tool.
- Do not inspect or clean the tool while the hydraulic power source is connected. Accidental engagement of the tool can cause serious injury.
- Always connect hoses to the tool hose couplers before energizing the hydraulic power source. Be sure all hose connections are tight.
- Do not operate the tool at oil temperatures above 140 °F/60 °C. Operation at higher temperatures can cause higher than normal temperatures at the tool which can result in operator discomfort.
- Do not operate a damaged, improperly adjusted, or incompletely assembled tool.
- Do not inspect, clean or replace the pruner blade while the hydraulic power source is connected.
- Never wear loose clothing that can get entangled in the working parts of the tool.
- Keep all parts of your body away from the pruner blade.
- Do not overreach. Maintain proper footing and balance at all times.
- Keep the pruner blade off all surfaces when starting the tool.
- If used near energized electric lines, maintain working distances according to OSHA guidelines for working near energized lines (ref. Section 1926.950). Failure to comply with this warning could result in serious personal injury.
- To avoid personal injury or equipment damage, all tool repair, maintenance and service must only be performed by authorized and properly trained personnel.
- Never cock, jam or wedge the blade during operation.
- Eye injury, and cutting or severing of body parts is possible if proper procedures are not followed.
- Ensure that the blade is correctly mounted before use.
- If the tool is dropped with a blade installed, the blade and associated parts should be examined thoroughly before use.
- Only use blades manufactured by Stanley Hydraulic Tools. Stanley assumes no responsibility for failure in equipment, accidental damage, or accidental injury as a result of the use of blades not manufactured by Stanley Hydraulic Tools.
- Always ensure the blade is sharp. Do not try to use the tool with a dull blade.

ELECTRICAL HAZARDS

The following guidelines must be followed to prevent accidental contact with overhead electrical conductors and/or communication wires and cables. (ref. ANSI Z133.1-2000)

WORKING IN PROXIMITY TO ELECTRICAL HAZARDS

An inspection shall be made by a qualified arborist to determine whether an electrical hazard exists before climbing, or otherwise entering, or performing work in or on a tree.

Only qualified line-clearance arborists or qualified line-clearance arborist trainees shall be assigned to work where an electrical hazard exists. Qualified line-clearance arborist trainees shall be under the direct supervision of qualified line-clearance arborist.

A second qualified line-clearance arborists or line-clearance arborist trainees shall be within vision or voice communication during line-clearing operations aloft when line-clearance arborists or line-clearance arborist trainees must approach closer than 10 feet (3.05 me-

ters) to any energized electrical conductor in excess of 750 volts (primary conductor) or when:

1. Branches or limbs being removed cannot first be cut (with a pole pruner/pole saw) to sufficiently clear electrical conductors, so as to avoid contact.
2. Roping is required to remove branches or limbs from such electrical conductors. This does not apply to individuals working on behalf of, or employed by, electrical system owners/operators engaged in line-clearing operations incidental to their normal occupation.

Qualified line-clearance arborists and line-clearance arborist trainees shall maintain minimum approach distances from energized electrical conductors in accordance with Table 1.

All other arborists shall maintain a minimum approach distance from energized electrical conductors in accordance with Table 2.

Branches hanging on an energized electrical conductor shall be removed using non-conductive equipment.

Table 1 – Minimum approach distances from energized conductors for qualified line-clearance arborists and qualified line-clearance arborist trainees.

Nominal Voltage (kV phase-to-phase)	Includes 1910.269 elevation factor, sea level to 5000 ft ¹		Includes 1910.269 elevation factor, 5001 – 10,000 ft ¹		Includes 1910.269 elevation factor, 10,000 – 14,000 ft ¹	
	ft-in	m	ft-in	m	ft-in	m
0.05 to 1.0	Avoid contact		Avoid contact		Avoid contact	
1.1 to 15.0	2-04	0.71	2-08	0.81	2-10	0.86
15.1 to 36.0	2-09	0.84	3-02	0.97	3-05	1.04
36.1 to 46.0	3-00	0.92	3-05	1.04	3-09	1.14
46.1 to 72.5	3-09	1.14	4-03	1.30	4-07	1.40
72.6 to 121.0	4-06	1.37	5-02	1.58	5-07	1.70
138.0 to 145.0	5-02	1.58	5-11	1.80	6-05	1.96
161.0 to 169.0	6-00	1.83	6-10	2.08	7-05	2.26
230.0 to 242.0	7-11	2.41	9-00	2.75	9-09	2.97
345.0 to 362.0	13-02	4.02	15-00	4.58	16-03	4.96
500.0 to 550.0	19-00	5.80	21-09	6.63	23-06	7.17
765.0 to 800.0	27-04	8.34	31-03	9.53	33-10	10.32

1. Exceeds phase-to-ground; elevation factor per 29 CFR 1910.269.

ELECTRICAL HAZARDS

Table 2 – Minimum approach distances to energized conductors for persons other than qualified line-clearance arborists and qualified line-clearance arborist trainees.

Nominal Voltage kV phase-to-phase ¹	Distance	
	ft-in	m
0.0 – 1.0	10-00	3.05
1.1 – 15.0	10-00	3.05
15.1 – 36.0	10-00	3.05
36.1 – 50.0	10-00	3.05
50.1 – 72.5	10-09	3.28
72.6 – 121.0	12-04	3.76
138.0 – 145.0	13-02	4.00
161.0 – 169.0	14-00	4.24
230.0 – 242.0	16-05	4.97
345.0 – 362.0	20-05	6.17
500.0 – 550.0	26-08	8.05
785.0 – 800.0	35-00	10.55
1. Exceeds phase-to-ground.		

The tie-in position should be above the work area and located in such a way that a slip would swing the arborist away from any energized electrical conductors or other identified hazard.

While climbing, the arborist should climb on the side of the tree that is away from energized electrical conductors as required in Tables 1 and 2.

Footwear, including lineman's overshoes, having electrical-resistant soles, shall not be considered as providing any measure of safety from electrical hazards.

Rubber gloves, with or without leather or other protective covering, shall not be considered as providing any measure of safety from electrical hazards.

Ladders, platforms and aerial devices, including insulated aerial devices, shall be subject to minimum approach distances in Table 1 and 2.

Aerial devices and attached equipment (such as chippers) contacting energized electrical conductors shall be considered energized. Contact shall be avoided, except where emergency rescue procedures are being carried out. Emergency rescue should be performed in accordance with 4.3.

STORM WORK AND EMERGENCY CONDITIONS-LINE CLEARANCE

Line clearance shall not be performed during adverse weather conditions such as thunderstorms, high winds and snow and ice storms.

Qualified line-clearance arborists and qualified line-clearance arborists trainees performing line clearance in the aftermath of a storm or under similar conditions shall be trained in the special hazards associated with this type of work.

Line-clearance operations shall be suspended when storm work or emergency conditions develop involving energized electrical conductors. Electrical system owners/operators shall be notified immediately.

TOOL STICKERS & TAGS



03783
GPM Sticker 3–9 2000 PSI

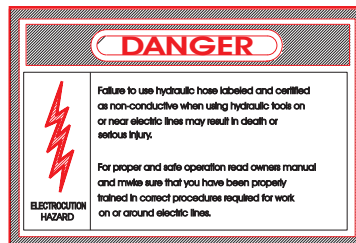

12412
Warning Sticker—Electrical



03693
Closed Center Decal

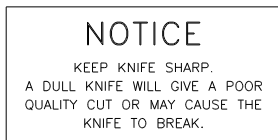

25910
Notice Sticker

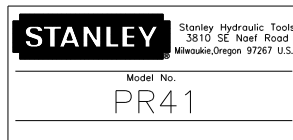

28502
PR41 Name Tag

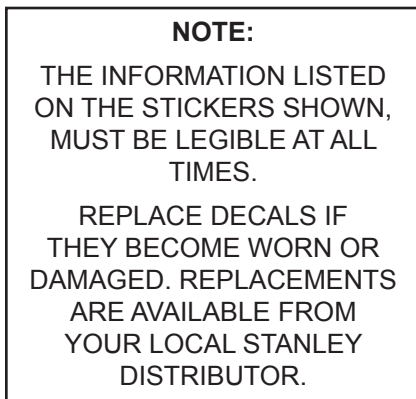

The safety tag (P/N 15875) at right is attached to the tool when shipped from the factory. Read and understand the safety instructions listed on this tag before removal. We suggest you retain this tag and attach it to the tool when not in use.

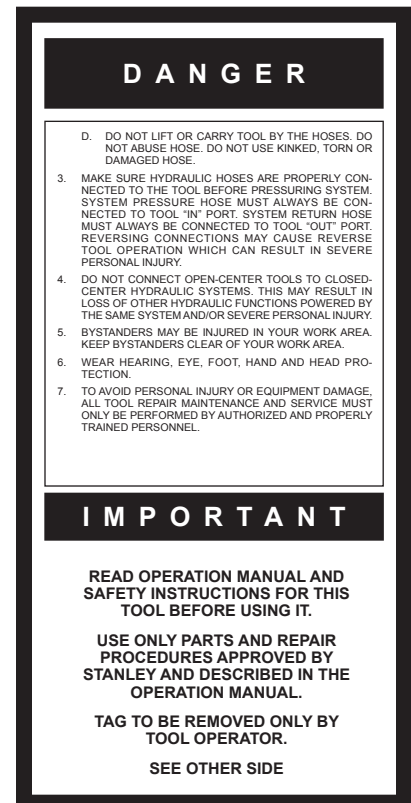
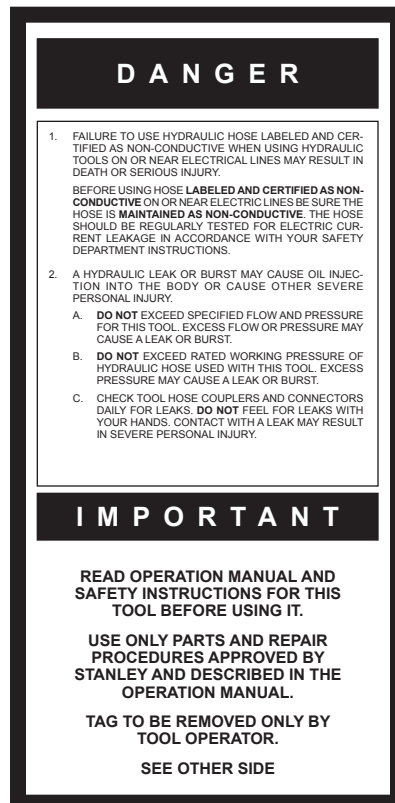

SAFETY TAG P/N 15875 (Shown smaller than actual size)

HOSE TYPES

The rated working pressure of the hydraulic hose must be equal to or higher than the relief valve setting on the hydraulic system. There are three types of hydraulic hose that meet this requirement and are authorized for use with Stanley Hydraulic Tools. They are:

Certified non-conductive — constructed of thermoplastic or synthetic rubber inner tube, synthetic fiber braid reinforcement, and weather resistant thermoplastic or synthetic rubber cover. *Hose labeled **certified non-conductive** is the only hose authorized for use near electrical conductors.*

Wire-braided (conductive) — constructed of synthetic rubber inner tube, single or double wire braid reinforcement, and weather resistant synthetic rubber cover. *This hose is **conductive** and must never be used near electrical conductors.*

Fabric-braided (not certified or labeled non-conductive) — constructed of thermoplastic or synthetic rubber inner tube, synthetic fiber braid reinforcement, and weather resistant thermoplastic or synthetic rubber cover. *This hose is **not certified non-conductive** and must never be used near electrical conductors.*

HOSE SAFETY TAGS

To help ensure your safety, the following DANGER tags are attached to all hose purchased from Stanley Hydraulic Tools. DO NOT REMOVE THESE TAGS.

If the information on a tag is illegible because of wear or damage, replace the tag immediately. A new tag may be obtained from your Stanley Distributor.

THE TAG SHOWN BELOW IS ATTACHED TO “CERTIFIED NON-CONDUCTIVE” HOSE

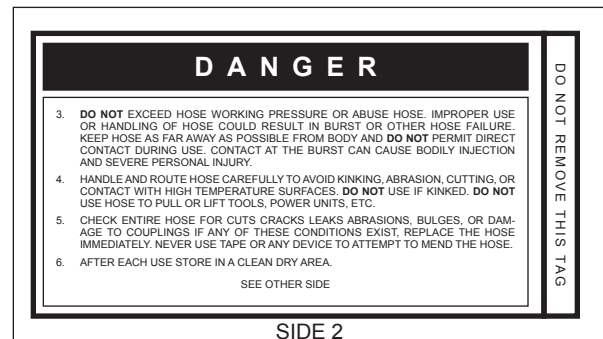
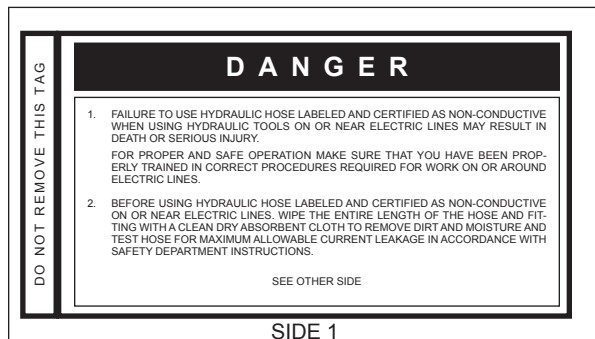

(Shown smaller than actual size)

THE TAG SHOWN BELOW IS ATTACHED TO “CONDUCTIVE” HOSE.

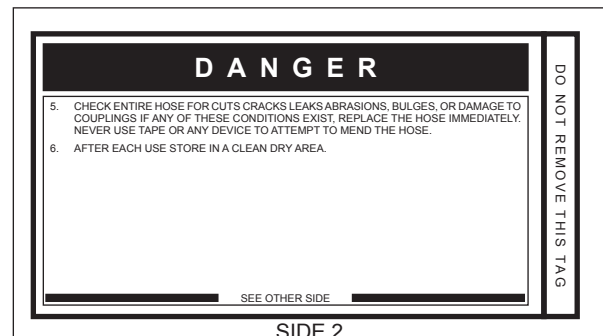
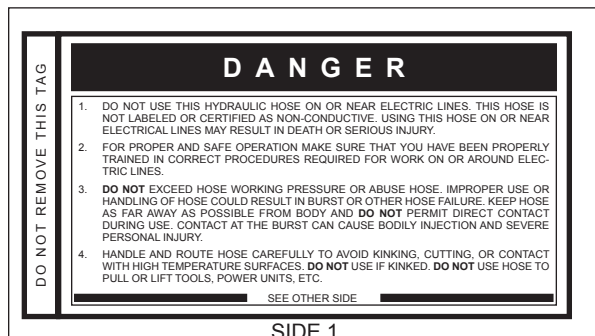

(Shown smaller than actual size)

HOSE RECOMMENDATIONS

Tool to Hydraulic Circuit Hose Recommendations

The chart to the right shows recommended minimum hose diameters for various hose lengths based on gallons per minute (gpm)/liters per minute (lpm). These recommendations are intended to keep return line pressure (back pressure) to a minimum acceptable level to ensure maximum tool performance.

This chart is intended to be used for hydraulic tool applications only based on Stanley Hydraulic Tools tool operating requirements and should not be used for any other applications.

All hydraulic hose must have at least a rated minimum working pressure equal to the maximum hydraulic system relief valve setting.

All hydraulic hose must meet or exceed specifications as set forth by SAE J517.

Oil Flow		Hose Lengths		Inside Diameter		USE (Press/Return)	Min. Working Pressure	
GPM	LPM	FEET	METERS	INCH	MM		PSI	BAR
Certified Non-Conductive Hose - Fiber Braid - for Utility Bucket Trucks								
4-9	15-34	up to 10	up to 3	3/8	10	Both	2250	155
Conductive Hose - Wire Braid or Fiber Braid - DO NOT USE NEAR ELECTRICAL CONDUCTORS								
4-6	15-23	up to 25	up to 7.5	3/8	10	Both	2500	175
4-6	15-23	26-100	7.5-30	1/2	13	Both	2500	175
5-10.5	19-40	up to 50	up to 15	1/2	13	Both	2500	175
5-10.5	19-40	51-100	15-30	5/8	16	Both	2500	175
5-10.5	19-40	100-300	30-90	5/8	16	Pressure	2500	175
10-13	38-49	up to 50	up to 15	3/4	19	Return	2500	175
10-13	38-49	51-100	15-30	5/8	16	Both	2500	175
10-13	38-49	100-200	30-60	3/4	19	Pressure	2500	175
13-16	49-60	up to 25	up to 8	5/8	16	Pressure	2500	175
13-16	49-60	26-100	8-30	3/4	19	Return	2500	175
				1	25.4	Return	2500	175
				5/8	16	Pressure	2500	175
				3/4	19	Return	2500	175
				3/4	19	Pressure	2500	175
				1	25.4	Return	2500	175

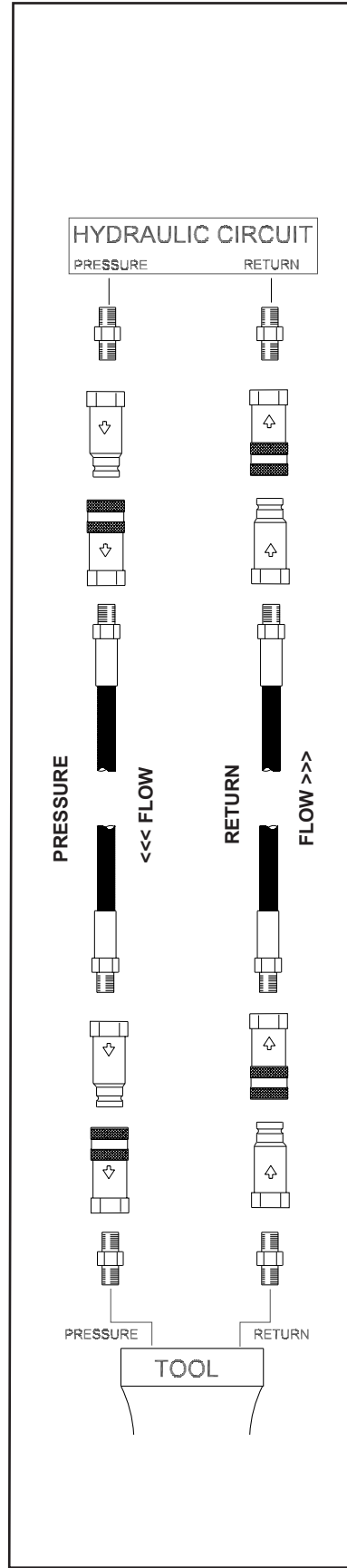

Figure 1. Typical Hose Connections

HTMA / EHTMA REQUIREMENTS

HTMA / EHTMA REQUIREMENTS

HTMA





HYDRAULIC SYSTEM REQUIREMENTS

TOOL TYPE

	TYPE I	TYPE II	TYPE RR	TYPE III
Flow Range	4-6 gpm (15-23 lpm)	7-9 gpm (26-34 lpm)	9-10.5 gpm (34-40 lpm)	11-13 gpm (42-49 lpm)
Nominal Operating Pressure (at the power supply outlet)	1500 psi (103 bar)	1500 psi (103 bar)	1500 psi (103 bar)	1500 psi (103 bar)
System relief valve setting (at the power supply outlet)	2100-2250 psi (145-155 bar)	2100-2250 psi (145-155 bar)	2200-2300 psi (152-159 bar)	2100-2250 psi (145-155 bar)
Maximum back pressure (at tool end of the return hose)	250 psi (17 bar)	250 psi (17 bar)	250 psi (17 bar)	250 psi (17 bar)
Measured at a max. fluid viscosity of: (at min. operating temperature)	400 ssu* (82 centistokes)	400 ssu* (82 centistokes)	400 ssu* (82 centistokes)	400 ssu* (82 centistokes)
Temperature: Sufficient heat rejection capacity to limit max. fluid temperature to: (at max. expected ambient temperature)	140° F (60° C)	140° F (60° C)	140° F (60° C)	140° F (60° C)
Min. cooling capacity at a temperature difference of between ambient and fluid temps	3 hp (2.24 kW) 40° F (22° C)	5 hp (3.73 kW) 40° F (22° C)	6 hp (5.22 kW) 40° F (22° C)	7 hp (4.47 kW) 40° F (22° C)
NOTE: Do not operate the tool at oil temperatures above 140° F (60° C). Operation at higher temperatures can cause operator discomfort at the tool.				
Filter Min. full-flow filtration Sized for flow of at least: (For cold temp. startup and max. dirt-holding capacity)	25 microns 30 gpm (114 lpm)	25 microns 30 gpm (114 lpm)	25 microns 30 gpm (114 lpm)	25 microns 30 gpm (114 lpm)
Hydraulic fluid Petroleum based (premium grade, anti-wear, non-conductive) Viscosity (at min. and max. operating temps)	100-400 ssu*	100-400 ssu* (20-82 centistokes)	100-400 ssu*	100-400 ssu*
NOTE: When choosing hydraulic fluid, the expected oil temperature extremes that will be experienced in service determine the most suitable temperature viscosity characteristics. Hydraulic fluids with a viscosity index over 140 will meet the requirements over a wide range of operating temperatures.				
*SSU = Saybolt Seconds Universal				

EHTMA HYDRAULIC SYSTEM REQUIREMENTS

CLASSIFICATION

					
Flow Range	3.5-4.3 gpm (13.5-16.5 lpm)	4.7-5.8 gpm (18-22 lpm)	7.1-8.7 gpm (27-33 lpm)	9.5-11.6 gpm (36-44 lpm)	11.8-14.5 gpm (45-55 lpm)
Nominal Operating Pressure (at the power supply outlet)	1870 psi (129 bar)	1500 psi (103 bar)	1500 psi (103 bar)	1500 psi (103 bar)	1500 psi (103 bar)
System relief valve setting (at the power supply outlet)	2495 psi (172 bar)	2000 psi (138 bar)	2000 psi (138 bar)	2000 psi (138 bar)	2000 psi (138 bar)

NOTE: These are general hydraulic system requirements. See tool specification page for tool specific requirements

OPERATION

PREPARATION FOR INITIAL USE

Each unit as shipped has no special unpacking or assembly requirements prior to usage. Inspection to assure the unit was not damaged in shipping and does not contain packing debris is all that is required. After installation of hoses and couplers a unit may be put to use.

CHECK HYDRAULIC POWER SOURCE

1. Using a calibrated flowmeter and pressure gauge, check that the hydraulic power source develops a flow of 3–9 gpm/11–34 lpm at 1000–2000 psi/70–140 bar.
2. Make certain the hydraulic power source is equipped with a relief valve set to open at 2100–2250 psi/145–155 bar minimum.
3. Check that the tool is designed for the hydraulic system type open-center (OC) or closed-center (CC) operation). See the Parts Illustration for location of marks which identify the tool as an OC or CC tool.

CHECK TOOL

1. Make sure all tool accessories are correctly installed. Failure to install tool accessories properly can result in damage to the tool or personal injury.
2. There should be no signs of leaks.
3. The tool should be clean, with all fittings and fasteners tight.
4. The tool must be periodically inspected for electric insulation quality to ensure that it has kept its original factory quality per OSHA 100 kV/A requirement.

CHECK TRIGGER MECHANISM

1. Check that the trigger operates smoothly and is free to travel between the **ON** and **OFF** positions.

CONNECT HOSES

1. Wipe all hose couplers with a clean lint-free cloth before making connections.
2. Connect the hoses from the hydraulic power source to the hose couplers on the tool. It is a good practice to connect the return hose first and disconnect it last to minimize or avoid trapped pressure within the saw motor.
3. Observe flow indicators stamped on hose couplers to be sure that oil will flow in the proper direction. The female coupler is the inlet coupler.

NOTE:

The pressure increase in uncoupled hoses left in the sun may result in making them difficult to connect. When possible, connect the free ends of operating hoses together.

OPERATING PROCEDURES

IMPORTANT

READ AND BECOME FAMILIAR WITH THE SECTIONS IN THIS MANUAL ON SAFETY PRECAUTIONS, TOOL STICKERS AND TAGS, HYDRAULIC HOSE REQUIREMENTS, HYDRAULIC REQUIREMENTS, AND PRE-OPERATION PROCEDURES BEFORE USING THIS PRODUCT.

- Observe all safety precautions.
- Do not operate a pruner unless you have been specifically trained to do so.
- Keep all parts of the body away from the pruner blade during operation of the tool.
- Carry the pruner with the unit de-energized and the blade away from the body.
- Always connect the hoses to the tool hose couplers before energizing the power source.
- Do not operate a pruner that is damaged, improperly adjusted or is not completely and securely assembled.
- Keep the tool clean and free of oil and contaminants.
- Do not hang the pruner on utility wires or cables.
- Do not leave the pruner hanging in a tree.
- Do not leave cut branches in a tree.
- Branches bent under tension are considered hazardous.
- Do not allow binding of the pruner blade.
- Keep away from energized electric lines the minimum distance per OSHA guidelines.
- Do not inspect, clean or repair the pruner with the power source operating or with operating pressure at the pruner. Accidental engagement of the tool can cause serious injury.

OPERATION

⚠ WARNING

The following are general wood cutting procedures and techniques. Differences in the terrain, vegetation, and type of wood will make this information more or less valid for particular areas.

For advice on specific wood cutting problems or techniques for your area, consult your local Stanley representative or your county agent. They can often provide information that will make your work safer and more productive.

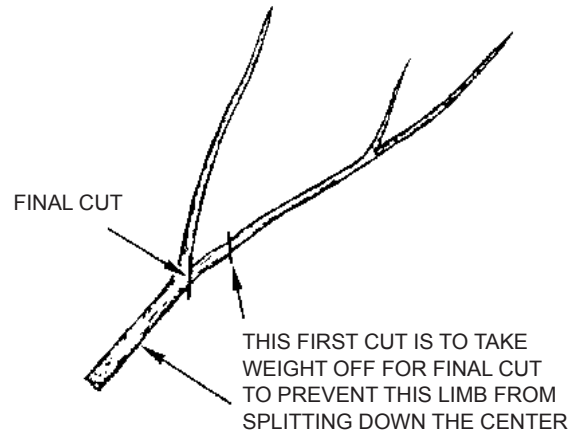

Figure 3. Example of Final Cut

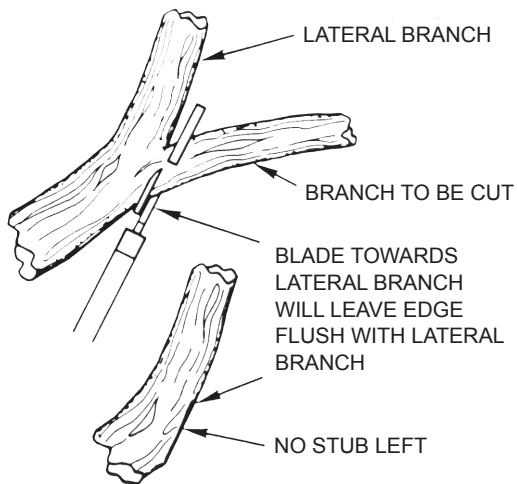

Figure 2. Example of Lateral Branch Cut

⚠ WARNING

Do not cut material that is directly overhead. When it falls it may cause operator injury.

TOOL PROTECTION & CARE

NOTICE

In addition to the Safety Precautions found in this manual, observe the following for equipment protection and care.

- Make sure all couplers are wiped clean before connection.
- The hydraulic circuit control valve must be in the OFF position when coupling or uncoupling hydraulic tools. Failure to do so may result in damage to the quick couples and cause overheating of the hydraulic system.
- Always store the tool in a clean dry space, safe from damage or pilferage.
- Make sure the circuit PRESSURE hose (with male quick disconnect) is connected to the IN port. The circuit RETURN hose (with female quick disconnect) is connected to the opposite port. Do not reverse circuit flow. This can cause damage to internal seals.
- Always replace hoses, couplings and other parts with replacement parts recommended by Stanley Hydraulic Tools. Supply hoses must have a minimum working pressure rating of 2500 psi/172 bar.
- Do not exceed the rated flow (see Specifications) in this manual for correct flow rate and model number. Rapid failure of the internal seals may result.
- Always keep critical tool markings, such as warning stickers and tags legible.
- Do not use the tool for applications it was not designed for. The pruner is intended to cut wood only.
- Keep blade sharp for maximum tool performance.
- Tool repair should be performed by experienced personnel only.
- Make certain that the recommended relief valves are installed in the pressure side of the system.
- Do not use the tool for applications for which it was not intended.

TROUBLESHOOTING

If symptoms of poor performance develop, the following chart can be used as a guide to correct the problem.

When diagnosing faults in operation of the tool, always make sure the hydraulic power source is supplying the correct hydraulic flow and pressure as listed in the table. Use a flowmeter know to be accurate. Check the flow with the hydraulic fluid temperature at least 80 °F/27 °C.

PROBLEM	CAUSE	SOLUTION
Tool will not operate.	Hydraulic system not engaged or running.	Engage or start hydraulic system.
	Hydraulic system control valve OFF .	Turn the system control valve ON .
	Tool not connected to the Hydraulic system.	Connect tool to the system.
Trigger and valve spool stick.	Damaged trigger guard.	Have repaired by authorized dealer.
	High back pressure.	Determine cause of high back pressure in return line and remove restriction.
	Tool reverse plumbed to the system.	Correctly connect the pressure and return lines.
	Valve spool or spool bore scored by contaminated hydraulic fluid.	Have repaired by authorized dealer.
Pruner cuts poorly.	Blade is dull.	Replace with sharp blade.
	Pruner is running backwards.	Check direction of blade cut. Correct direction is for blade to cut when squeezing the trigger. Blade should be retracted when not squeezing the trigger.
	System relief valve set too low.	Check system relief and adjust relief valve to crack open at 2100 psi.
	Piston seal leaks or piston or cylinder is damaged.	Have inspected and repaired by authorized dealer.
Hydraulic oil leaks between valve handle and outer tube handle.	Seals worn or piston rod worn.	Have repaired by authorized dealer.

SPECIFICATIONS

Capacity.....	2-1/4 inch/5.7 cm cut
Pressure Range.....	1000–2000 psi/70–140 bar
Maximum Back Pressure.....	250 psi/17 bar
Flow Range	3–9 gpm/11–34 lpm
Porting	3/8 NPT Female Pipe Thread
Connect Size and Type	3/8 in. NPT × 3/8 in. NPT Male Pipe Hex Nipple
Hose Whips	No
Weight	11.5 lb/5.2 kg
Overall Length	84.25 in./214 cm
Maximum Fluid Temperature	140 °F/60 °C

ACCESSORIES

DESCRIPTION	PART NO.
Knife Blade	58649
Certified Non-Conductive Dual Oil Resistant Hose, 3/8 in. dia. × 10 ft with guards	05005

PR41 PARTS ILLUSTRATION

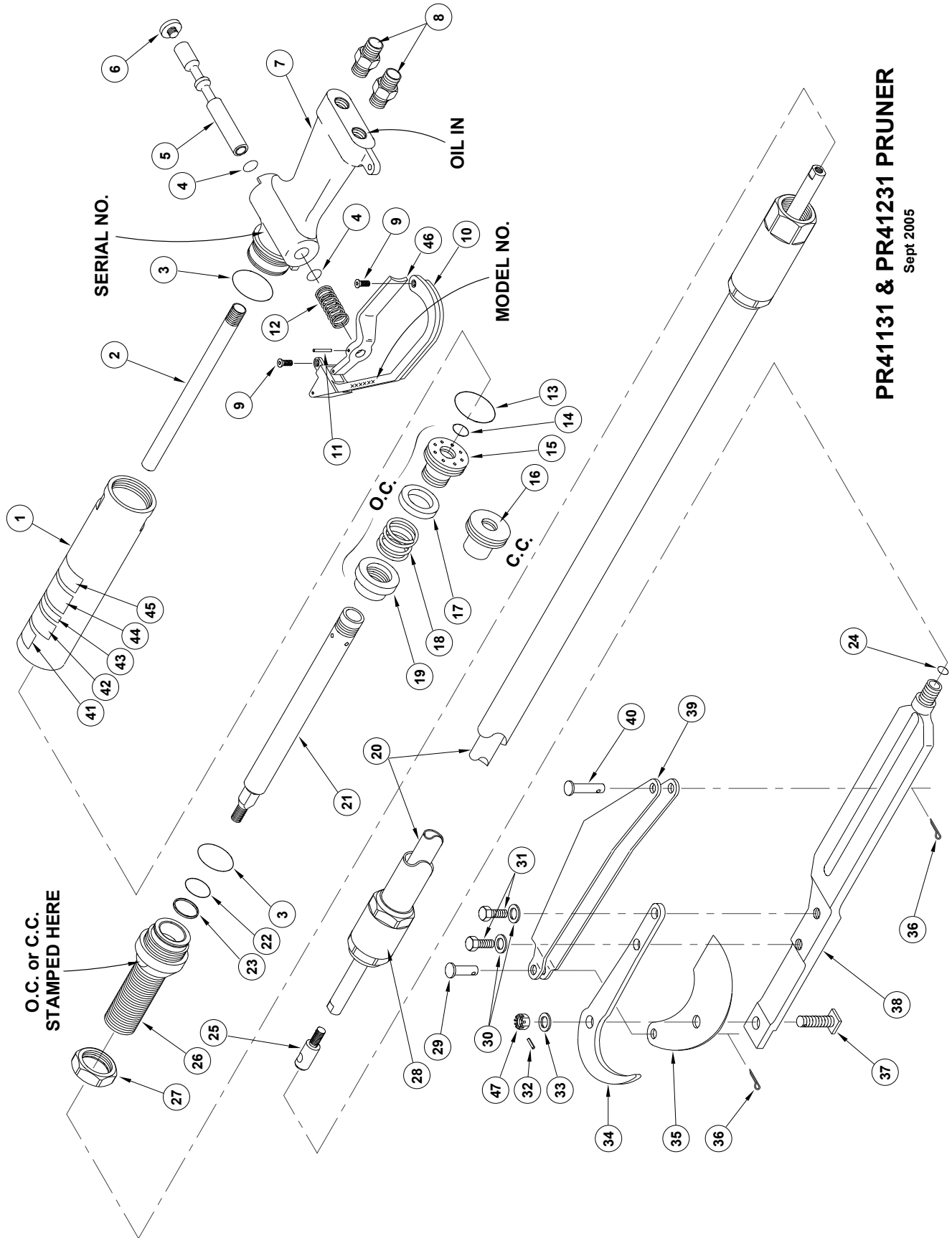

PR41131 & PR41231 PRUNER

Sept 2005

PR41 PARTS LIST

ITEM	PART NO.	QTY	DESCRIPTION
1	28415	1	CYLINDER
2	28416	1	CYLINDER OIL TUBE
3	00252	2	O-RING
4	00175	2	O-RING
5	01809	1	SPOOL
6	01812	1	SPOOL SCREW
7	73650	1	VALVE HANDLE ASSY
8	00936	2	HEX NIPPLE
9	22147	2	CAPSCREW
10	51182	1	TRIGGER GUARD
11	01534	1	ROLL PIN
12	16556	1	SPRING
13	00560	1	O-RING
14	00018	1	O-RING
15	00535	1	PISTON (PR41131, PR4113101)
16	18885	1	PISTON (PR41231 ONLY)
17	00539	1	DISC VALVE (PR41131, PR4113101 ONLY)
18	00552	1	DISC VALVE SPRING (PR41131, PR4113101 ONLY)
19	00534	1	PISTON NUT (PR41131, PR4113101)
20	36133	1	INTERNAL TUBE ASSY
21	36128	1	PISTON ROD
22	00574	1	O-RING
23	01815	1	BACK-UP RING
24	01211	1	O-RING
25	08248	1	SLIDE LINK BOLT
26	28418	1	TUBE COUPLING
27	28432	1	LOCK NUT
28	36130	1	EXTERNAL TUBE ASSY
29	08249	1	CLEVIS PIN
30	00283	2	LOCK WASHER
31	00569	2	CAPSCREW
32	00757	1	ROLL PIN
33	36237	1	WASHER
34	27747	1	HOOK
35	58649	1	KNIFE
36	03029	2	COTTER PIN
37	36213	1	KNIFE BOLT
38	08246	1	SLIDE HEAD ASSY
39	28401	1	LINK BAR
40	08247	1	CLEVIS PIN
41	—	1	DIELECTRIC TEST STICKER
42	12412	1	WARNING STICKER
43	03783	1	GPM STICKER

ITEM	PART NO.	QTY	DESCRIPTION
44	28502	1	NAME TAG
45	25910	1	NOTICE STICKER
46	51183	1	TRIGGER
47	05268	1	HEX SLOTTED NUT
	03693	1	CLOSED CENTER DECAL (PR41231 ONLY)
	03972	1	FEMALE COUPLER (SUPPLIED W/ PR4113103 ONLY)
	03973	1	MALE COUPLER (SUPPLIED W/ PR4113103 ONLY)
	03971	1	COUPLER SET (PR411303 ONLY)
	32473	1	SEAL KIT

NOTE:

Use Part Number and Part Name when ordering.

MODEL DESIGNATIONS

PR41131 Open Center (OC) only

PR41231 Closed Center (CC) only

PR413103 Open Center (OC) only

STANLEY®

Stanley Hydraulic Tools
3810 SE Naef Road
Milwaukie, Oregon 97267-5698 USA
(503) 659-5660 / Fax (503) 652-1780
www.stanleyhydraulics.com