

# STANLEY®

## TA54 HYDRAULIC TAMPER



### USER MANUAL Safety, Operation and Maintenance



© 2014 Stanley Black & Decker, Inc.  
New Britain, CT 06053  
U.S.A.  
62288 12/2014 Ver. 8



# TABLE OF CONTENTS

SAFETY SYMBOLS .....	4
SAFETY PRECAUTIONS.....	5
TOOL STICKERS & TAGS .....	6
HOSE TYPES.....	7
HOSE RECOMMENDATIONS .....	8
FIGURE 1. TYPICAL HOSE CONNECTIONS .....	8
HTMA REQUIREMENTS.....	9
OPERATION.....	10
TOOL PROTECTION & CARE .....	11
TROUBLESHOOTING .....	12
SPECIFICATIONS.....	14
ACCESSORIES.....	14
SERVICE TOOLS.....	14
TA54 PARTS ILLUSTRATION .....	15
TA54 PARTS LIST .....	16

## IMPORTANT

To fill out a Product Warranty Validation form, and for information on your warranty, visit [Stanleyhydraulics.com](http://Stanleyhydraulics.com) and select the Company tab, Warranty.  
(NOTE: The warranty Validation record must be submitted to validate the warranty).

**SERVICING:** This manual contains safety, operation, and routine maintenance instructions. Stanley Hydraulic Tools recommends that servicing of hydraulic tools, other than routine maintenance, must be performed by an authorized and certified dealer. Please read the following warning.

## ⚠ WARNING

**SERIOUS INJURY OR DEATH COULD RESULT FROM THE IMPROPER REPAIR OR SERVICE OF THIS TOOL.**

**REPAIRS AND / OR SERVICE TO THIS TOOL MUST ONLY BE DONE BY AN AUTHORIZED AND CERTIFIED DEALER.**

For the nearest authorized and certified dealer, call Stanley Hydraulic Tools at the number listed on the back of this manual and ask for a Customer Service Representative.

# SAFETY SYMBOLS

Safety symbols and signal words, as shown below, are used to emphasize all operator, maintenance and repair actions which, if not strictly followed, could result in a life-threatening situation, bodily injury or damage to equipment.



This is the safety alert symbol. It is used to alert you to potential personal injury hazards. Obey all safety messages that follow this symbol to avoid possible injury or death.



This safety alert and signal word indicate an imminently hazardous situation which, if not avoided, will result in death or serious injury.



This safety alert and signal word indicate a potentially hazardous situation which, if not avoided, could result in death or serious injury.



This safety alert and signal word indicate a potentially hazardous situation which, if not avoided, could result in death or serious injury.



This signal word indicates a potentially hazardous situation which, if not avoided, may result in property damage.



This signal word indicates a situation which, if not avoided, will result in damage to the equipment.



This signal word indicates a situation which, if not avoided, may result in damage to the equipment.

Always observe safety symbols. They are included for your safety and for the protection of the tool.

## LOCAL SAFETY REGULATIONS

Enter any local safety regulations here. Keep these instructions in an area accessible to the operator and maintenance personnel.

---

---

---

---

---

---

---

---

---

---

---

---

---

---

---

---

---

---

---

---

---

---

---

---

---

---

# SAFETY PRECAUTIONS

Tool operators and maintenance personnel must always comply with the safety precautions given in this manual and on the stickers and tags attached to the tool and hose.

These safety precautions are given for your safety. Review them carefully before operating the tool and before performing general maintenance or repairs.

Supervising personnel should develop additional precautions relating to the specific work area and local safety regulations. If so, place the added precautions in the space provided in this manual.

The TA54 Hydraulic Tamper will provide safe and dependable service if operated in accordance with the instructions given in this manual. Read and understand this manual and any stickers and tags attached to the tool and hoses before operation. Failure to do so could result in personal injury or equipment damage.



- Operator must start in a work area without bystanders. The operator must be familiar with all prohibited work areas such as excessive slopes and dangerous terrain conditions.
- Establish a training program for all operators to ensure safe operation.
- Do not operate the tool unless thoroughly trained or under the supervision of an instructor.
- Always wear safety equipment such as goggles, ear, head protection, and safety shoes at all times when operating the tool. Never wear loose clothing that can get entangled in the working parts of the tool.
- Do not inspect or clean the tool while the hydraulic power source is connected. Accidental engagement of the tool can cause serious injury.
- Supply hoses must have a minimum working pressure rating of 2500 psi/175 bar.
- Be sure all hose connections are tight.
- The hydraulic circuit control valve must be in the **OFF** position when coupling or uncoupling the tool. Wipe all couplers clean before connecting. Use only lint-free cloths. Failure to do so may result in damage to the quick couplers and cause overheating of the hydraulic system.
- Do not operate the tool at oil temperatures above 140 °F/60 °C. Operation at higher oil temperatures can cause operator discomfort and may damage the tool.
- Do not operate a damaged, improperly adjusted, or incompletely assembled tool.
- Know the location of buried or covered services before starting your work.
- To avoid personal injury or equipment damage, all tool repair, maintenance and service must only be performed by authorized and properly trained personnel.
- Do not exceed the rated limits of the tool or use the tool for applications beyond its design capacity.
- Always keep critical tool markings, such as labels and warning stickers legible.
- Always replace parts with replacement parts recommended by Stanley Hydraulic Tools.
- Without the use of non-conductive accessories, this tool is not for use near energized lines. Failure to comply with this warning could result in serious personal injury.
- Do not overreach. Maintain proper footing and balance at all times.
- Use care when handling the tamper. Do not carry the tool by the hoses.
- **Warning:** Use of this tool on certain materials during demolition could generate dust potentially containing a variety of hazardous substances such as asbestos, silica or lead. Inhalation of dust containing these or other hazardous substances could result in serious injury, cancer or death. Protect yourself and those around you. Research and understand the materials you are cutting. Follow correct safety procedures and comply with all applicable national, state or provisional health and safety regulations relating to them, including, if appropriate arranging for the safe disposal of the materials by a qualified person.

# TOOL STICKERS & TAGS



03783  
GPM Sticker 3–9 2000 PSI



14908  
TA54 Name Tag

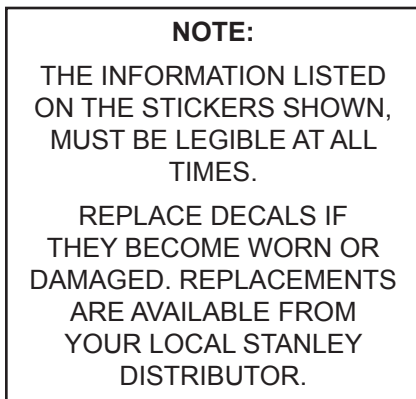

The safety tag (P/N 15875) at right is attached to the tool when shipped from the factory. Read and understand the safety instructions listed on this tag before removal. We suggest you retain this tag and attach it to the tool when not in use.

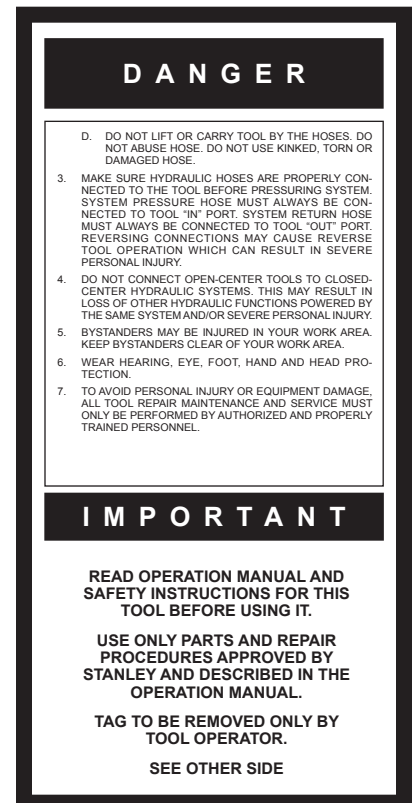
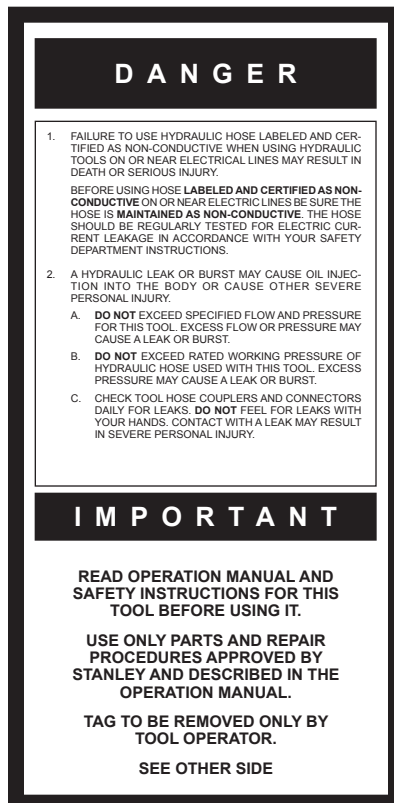

SAFETY TAG P/N 15875 (Shown smaller than actual size)

# HOSE TYPES

The rated working pressure of the hydraulic hose must be equal to or higher than the relief valve setting on the hydraulic system. There are three types of hydraulic hose that meet this requirement and are authorized for use with Stanley Hydraulic Tools. They are:

**Certified non-conductive** — constructed of thermoplastic or synthetic rubber inner tube, synthetic fiber braid reinforcement, and weather resistant thermoplastic or synthetic rubber cover. *Hose labeled **certified non-conductive** is the only hose authorized for use near electrical conductors.*

**Wire-braided** (conductive) — constructed of synthetic rubber inner tube, single or double wire braid reinforcement, and weather resistant synthetic rubber cover. *This hose is **conductive** and must never be used near electrical conductors.*

**Fabric-braided** (not certified or labeled non-conductive) — constructed of thermoplastic or synthetic rubber inner tube, synthetic fiber braid reinforcement, and weather resistant thermoplastic or synthetic rubber cover. *This hose is **not certified non-conductive** and must never be used near electrical conductors.*

## HOSE SAFETY TAGS

To help ensure your safety, the following DANGER tags are attached to all hose purchased from Stanley Hydraulic Tools. DO NOT REMOVE THESE TAGS.

If the information on a tag is illegible because of wear or damage, replace the tag immediately. A new tag may be obtained from your Stanley Distributor.

### THE TAG SHOWN BELOW IS ATTACHED TO “CERTIFIED NON-CONDUCTIVE” HOSE

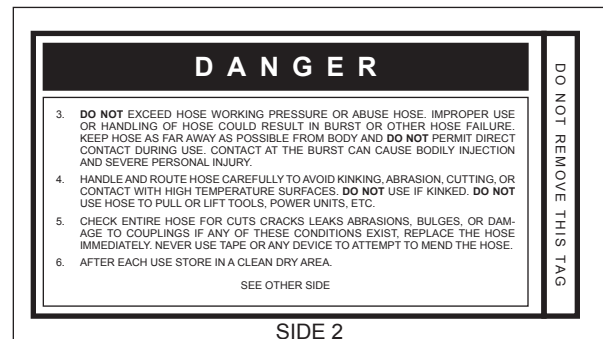
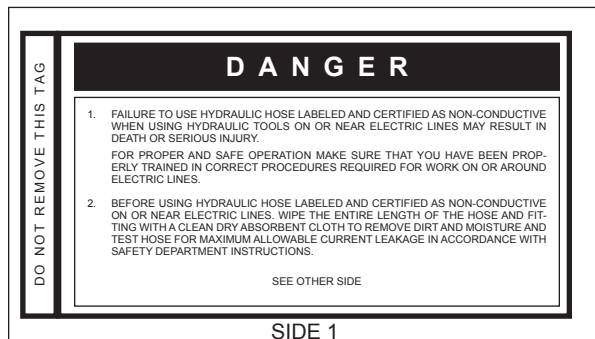

(Shown smaller than actual size)

### THE TAG SHOWN BELOW IS ATTACHED TO “CONDUCTIVE” HOSE.

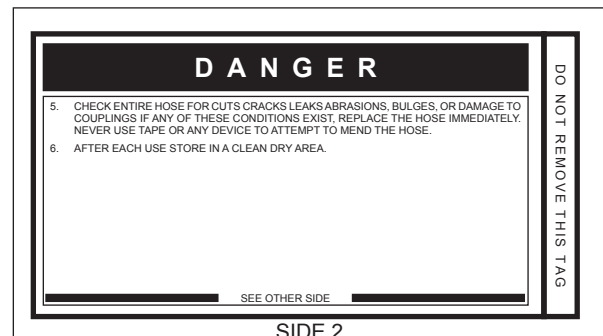
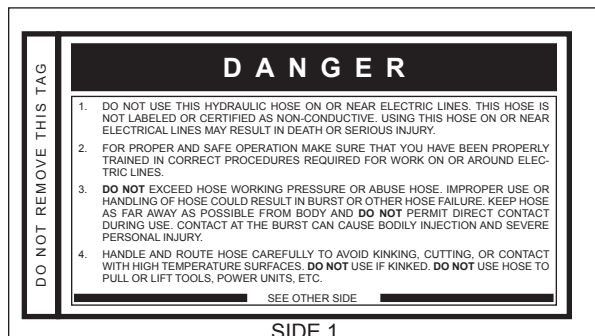

(Shown smaller than actual size)

# HOSE RECOMMENDATIONS

## Tool to Hydraulic Circuit Hose Recommendations

The chart to the right shows recommended minimum hose diameters for various hose lengths based on gallons per minute (gpm)/liters per minute (lpm). These recommendations are intended to keep return line pressure (back pressure) to a minimum acceptable level to ensure maximum tool performance.

This chart is intended to be used for hydraulic tool applications only based on Stanley Hydraulic Tools tool operating requirements and should not be used for any other applications.

All hydraulic hose must have at least a rated minimum working pressure equal to the maximum hydraulic system relief valve setting.

**All hydraulic hose must meet or exceed specifications as set forth by SAE J517.**

Oil Flow		Hose Lengths		Inside Diameter		USE (Press/Return)	Min. Working Pressure	
GPM	LPM	FEET	METERS	INCH	MM		PSI	BAR
<b>Certified Non-Conductive Hose - Fiber Braid - for Utility Bucket Trucks</b>								
4-9	15-34	up to 10	up to 3	3/8	10	Both	2250	155
<b>Conductive Hose - Wire Braid or Fiber Braid - DO NOT USE NEAR ELECTRICAL CONDUCTORS</b>								
4-6	15-23	up to 25	up to 7.5	3/8	10	Both	2500	175
4-6	15-23	26-100	7.5-30	1/2	13	Both	2500	175
5-10.5	19-40	up to 50	up to 15	1/2	13	Both	2500	175
5-10.5	19-40	51-100	15-30	5/8	16	Both	2500	175
5-10.5	19-40	100-300	30-90	5/8	16	Pressure	2500	175
10-13	38-49	up to 50	up to 15	3/4	19	Return	2500	175
10-13	38-49	51-100	15-30	5/8	16	Both	2500	175
10-13	38-49	100-200	30-60	3/4	19	Pressure	2500	175
13-16	49-60	up to 25	up to 8	5/8	16	Return	2500	175
13-16	49-60	26-100	8-30	3/4	19	Pressure	2500	175
				1	25.4	Return	2500	175
				5/8	16	Pressure	2500	175
				3/4	19	Return	2500	175
				3/4	19	Pressure	2500	175
				1	25.4	Return	2500	175

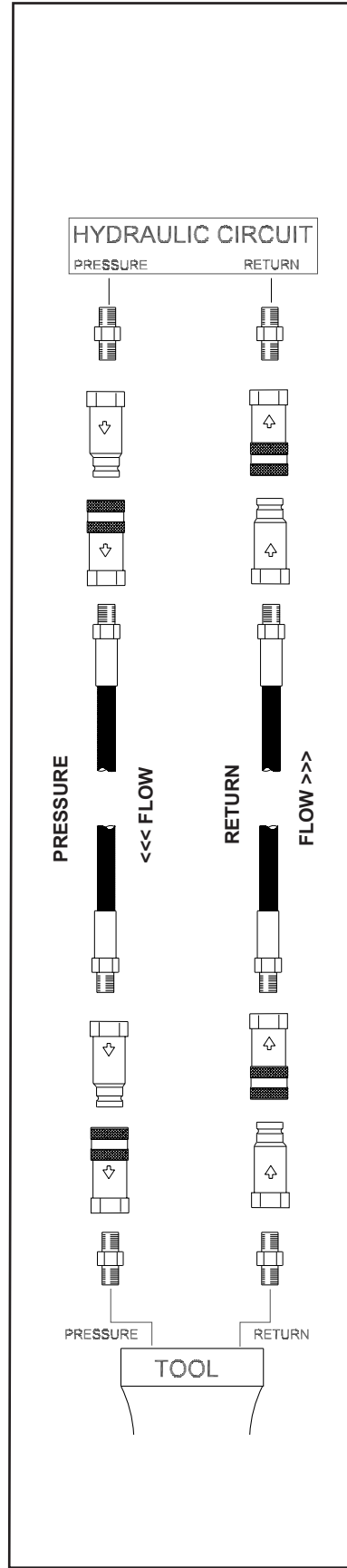

Figure 1. Typical Hose Connections



# HTMA / EHTMA REQUIREMENTS

## HTMA / EHTMA REQUIREMENTS

### HTMA

#### HYDRAULIC SYSTEM REQUIREMENTS

#### TOOL TYPE

	TYPE I	TYPE II	TYPE RR	TYPE III
Flow Range	4-6 gpm (15-23 lpm)	7-9 gpm (26-34 lpm)	9-10.5 gpm (34-40 lpm)	11-13 gpm (42-49 lpm)
Nominal Operating Pressure (at the power supply outlet)	1500 psi (103 bar)	1500 psi (103 bar)	1500 psi (103 bar)	1500 psi (103 bar)
System relief valve setting (at the power supply outlet)	2100-2250 psi (145-155 bar)	2100-2250 psi (145-155 bar)	2200-2300 psi (152-159 bar)	2100-2250 psi (145-155 bar)
Maximum back pressure (at tool end of the return hose)	250 psi (17 bar)	250 psi (17 bar)	250 psi (17 bar)	250 psi (17 bar)
Measured at a max. fluid viscosity of: (at min. operating temperature)	400 ssu* (82 centistokes)	400 ssu* (82 centistokes)	400 ssu* (82 centistokes)	400 ssu* (82 centistokes)
Temperature: Sufficient heat rejection capacity to limit max. fluid temperature to: (at max. expected ambient temperature)	140° F (60° C)	140° F (60° C)	140° F (60° C)	140° F (60° C)
Min. cooling capacity at a temperature difference of between ambient and fluid temps	3 hp (2.24 kW) 40° F (22° C)	5 hp (3.73 kW) 40° F (22° C)	6 hp (5.22 kW) 40° F (22° C)	7 hp (4.47 kW) 40° F (22° C)
<b>NOTE:</b> Do not operate the tool at oil temperatures above 140° F (60° C). Operation at higher temperatures can cause operator discomfort at the tool.				
Filter Min. full-flow filtration Sized for flow of at least: (For cold temp. startup and max. dirt-holding capacity)	25 microns 30 gpm (114 lpm)	25 microns 30 gpm (114 lpm)	25 microns 30 gpm (114 lpm)	25 microns 30 gpm (114 lpm)
Hydraulic fluid Petroleum based (premium grade, anti-wear, non-conductive) Viscosity (at min. and max. operating temps)	100-400 ssu*	100-400 ssu* (20-82 centistokes)	100-400 ssu*	100-400 ssu*
<b>NOTE:</b> When choosing hydraulic fluid, the expected oil temperature extremes that will be experienced in service determine the most suitable temperature viscosity characteristics. Hydraulic fluids with a viscosity index over 140 will meet the requirements over a wide range of operating temperatures.				
*SSU = Saybolt Seconds Universal				

### EHTMA HYDRAULIC SYSTEM REQUIREMENTS

### CLASSIFICATION

Flow Range	3.5-4.3 gpm (13.5-16.5 lpm)	4.7-5.8 gpm (18-22 lpm)	7.1-8.7 gpm (27-33 lpm)	9.5-11.6 gpm (36-44 lpm)	11.8-14.5 gpm (45-55 lpm)
Nominal Operating Pressure (at the power supply outlet)	1870 psi (129 bar)	1500 psi (103 bar)	1500 psi (103 bar)	1500 psi (103 bar)	1500 psi (103 bar)
System relief valve setting (at the power supply outlet)	2495 psi (172 bar)	2000 psi (138 bar)	2000 psi (138 bar)	2000 psi (138 bar)	2000 psi (138 bar)

**NOTE:** These are general hydraulic system requirements. See tool specification page for tool specific requirements

# OPERATION

## PRE-OPERATION PROCEDURES

### PREPARATION FOR INITIAL USE

The tool, as shipped, has no special unpacking or assembly requirements prior to usage. Inspection to assure the tool was not damaged in shipping and does not contain packing debris is all that is required.

### CHECK HYDRAULIC POWER SOURCE

1. Using a calibrated flowmeter and pressure gauge, check that the hydraulic power source develops a flow of 3–9 gpm/11–34 lpm at 1000–2000 psi/70–140 bar.
2. Make certain the hydraulic power source is equipped with a relief valve set to open at 2250 psi/155 bar maximum.
3. Check that the hydraulic circuit matches the tool for open-center (OC) operation.

### CHECK TOOL

1. Make sure all tool accessories are correctly installed. Failure to install tool accessories properly can result in damage to the tool or personal injury.
2. There should be no signs of leaks.
3. The tool should be clean, with all fittings and fasteners tight.

### CHECK TRIGGER MECHANISM

1. Check that the trigger operates smoothly and is free to travel between the **ON** and **OFF** positions.

## OPERATING PROCEDURES

1. Observe all safety precautions.
2. Place the tamper on the surface to be compacted.
3. Squeeze the trigger to start the tamper.

### **⚠ WARNING**

The tamper will rise quickly when first turned on. Do not stand over or place any part of your body on top of the tamper. Wear safety shoes.

#### NOTE:

Partially depressing the trigger allows the tool to operate at a slow speed, making it easy to start the tamper on the surface to be compacted.

4. Guide the tamper using both hands. One on the On/Off valve trigger and the other at the tapered section at the end of the handle tube.
5. When back-filling a deep hole, compact (tamp) the back-fill after a maximum of 6 inches/15 cm of material is added to the hole. This will ensure maximum compaction of the filled hole and minimize any setting that may occur.

## COLD WEATHER OPERATION

If the tool is to be used during cold weather, preheat the hydraulic fluid at low engine speed. When using the normally recommended fluids, fluid temperature should be at or above 50 °F/10 °C (400 ssu/82 centistokes) before use.

## STORAGE

1. Disconnect the tool from the hydraulic power source.
2. Remove the tool bit and spray the chuck area with WD-40™ inside and out.
3. Wipe clean and store in a clean, dry place.

## TOOL PROTECTION & CARE

### NOTICE

In addition to the Safety Precautions found in this manual, observe the following for equipment protection and care.

- Make sure all couplers are wiped clean before connection.
- The hydraulic circuit control valve must be in the **OFF** position when coupling or uncoupling hydraulic tools. Failure to do so may result in damage to the quick couplers and cause overheating of the hydraulic system.
- Always store the tool in a clean dry space, safe from damage or pilferage.
- Make sure the circuit **PRESSURE** hose (with male quick disconnect) is connected to the **IN** port. The circuit **RETURN** hose (with female quick disconnect) is connected to the opposite port. Do not reverse circuit flow. This can cause damage to internal seals.
- Always replace hoses, couplings and other parts with replacement parts recommended by Stanley Hydraulic Tools. Supply hoses must have a minimum working pressure rating of 2500 psi/172 bar.
- Do not exceed the rated flow (see Specifications) in this manual for correct flow rate and model number. Rapid failure of the internal seals may result.
- Always keep critical tool markings, such as warning stickers and tags legible.
- Tool repair should be performed by experienced personnel only.
- Make certain that the recommended relief valves are installed in the pressure side of the system.
- Do not use the tool for applications for which it was not intended.

# TROUBLESHOOTING

If symptoms of poor performance develop, the following chart can be used as a guide to correct the problem.

When diagnosing faults in operation of the tool, always make sure the hydraulic power source is supplying the correct hydraulic flow and pressure as listed in the table. Use a flowmeter known to be accurate. Check the flow with the hydraulic fluid temperature at least 80 °F/27 °C.

SYMPTOM	CAUSE	SOLUTION
Tool does not run.	Power unit not functioning.	Check power unit for proper flow and pressure (3–9 gpm/11–34 lpm at 1000–2000 psi/70–140 bar).
	Couplers or hoses blocked.	Remove restriction.
	Pressure and return line hoses reversed at ports.	Be sure hoses are connected to their proper ports.
	Mechanical failure.	Have inspected and repaired by an authorized Stanley dealer.
	Back-pressure too high.	Check hydraulic system for excessive back-pressure over 250 psi/17 bar measure at the end of the tool operating hose.
Tool does not compact effectively.	Power unit not functioning.	Check power unit for proper flow and pressure (3–9 gpm/11–34 lpm at 1000–2000 psi/70–140 bar).
	Couplers or hoses blocked.	Remove restriction.
	Back-pressure too high.	Check hydraulic system for excessive back-pressure over 250 psi/17 bar measure at the end of the tool operating hose.
	Fluid too hot (above 140 °F/60 °C) Fluid too cold (below 60 °F/15.5 °C)	Provide cooler to maintain proper oil temperature. Bypass cooler to warm up oil or provide cooler to maintain proper temperature.
	Tamper shoe too large for soil conditions.	Use smaller shoe for back-filling operations (P/N 01849).
Tool operates slow.	Low oil flow from power unit.	Check power source for proper flow.
	High back-pressure.	Check hydraulic system for excessive back-pressure and correct as required.
	Couplers or hoses blocked.	Remove restrictions.
	Fluid too hot (above 140 °F/60 °C) Fluid too cold (below 60 °F/15.5 °C)	Provide cooler to maintain proper oil temperature. Bypass cooler to warm up oil or provide cooler to maintain proper temperature.
Tamper gets hot.	Hot oil going through tool.	Check power unit. Be sure flow rate is not too high causing excess oil to go through the relief valve. Provide cooler to maintain proper oil temperature. Bypass cooler to warm up oil or provide cooler to maintain proper temperature (100–130 °F/38–54 °C). Eliminate flow control devices. Do not exceed recommended flow.

## TROUBLESHOOTING

SYMPTOM	CAUSE	SOLUTION
Oil leakage on piston rod.	Lower piston seal failure.	Replace seal and wiper, piston and nose as required.
Oil leakage around trigger.	Valve spool seal failure.	Replace seals.
Oil leakage around spool end caps.	O-ring failure.	Replace O-rings.
Piston extends but does not retract (reciprocate).	Pressure and return reversed.	Correct the proper flow direction at power unit or tool.
	Tool not assembled correctly.	Review service instructions for proper assembly or contact an authorized Stanley Hydraulic Tools distributor. Also check the following: <ol style="list-style-type: none"> <li>1. Flow sleeve lined up correctly with locating pin.</li> <li>2. Oil tubes reversed at ON/OFF valve.</li> <li>3. Front sleeve in correctly.</li> <li>4. Thrust bridge washer in correctly.</li> </ol>
	Back-pressure too high.	Check hydraulic system for excessive back-pressure over 250 psi/17 bar measure at the end of the tool operating hoses.

# SPECIFICATIONS

Oil Flow Range ..... 3-9 gpm/11-34 lpm  
 Pressure Range ..... 1000-2000 psi/70-140 Bar  
 Length ..... See Below  
 Weight ..... 25 lbs/11.3 kg  
 Porting ..... 1/2 in. SAE O-Ring Port or 3/8 Pipe Hose Ends  
 Couplers ..... HTMA/EHTMA Flush Face Type Male & Female  
 System Type ..... HTMA Type I and Type II

Handle Length	No valve	Valve in handle	Mid-valve
3 foot	66 inches/167 cm	55 inches/139 cm	
<b>System Type</b>	OC/CC	OC/CC	OC

## ACCESSORIES

Description	Part No.
Kidney Shoe .....	00833
Round Shoe, 6-inch Diameter .....	00840
Rectangular Shoe .....	01070
8 Ft Hose (2 required) .....	35784
In-Line Valve Assembly OC/CC .....	38632

## SERVICE TOOLS

Tamper Sleeve Tool .....	01120
Sleeve Installation Wrench .....	01949
O-ring Tool Kit .....	04337

# TA54 PARTS ILLUSTRATION

NOTE: The following models include adaptors and couplers TA54103, TA54603, TA54113, TA54113D & TA54113S

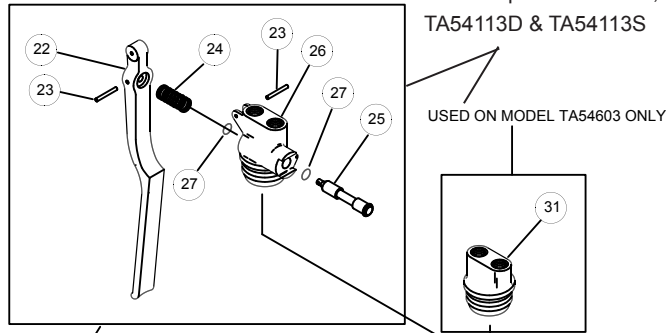

USED ON MODEL TA54603A ONLY  
SEE NOTE BELOW

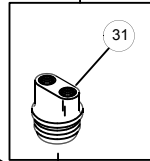

USED ON MODEL TA54103 ONLY  
ALSO USED ON MODELS TA54113,  
TA54113D & TA54113S

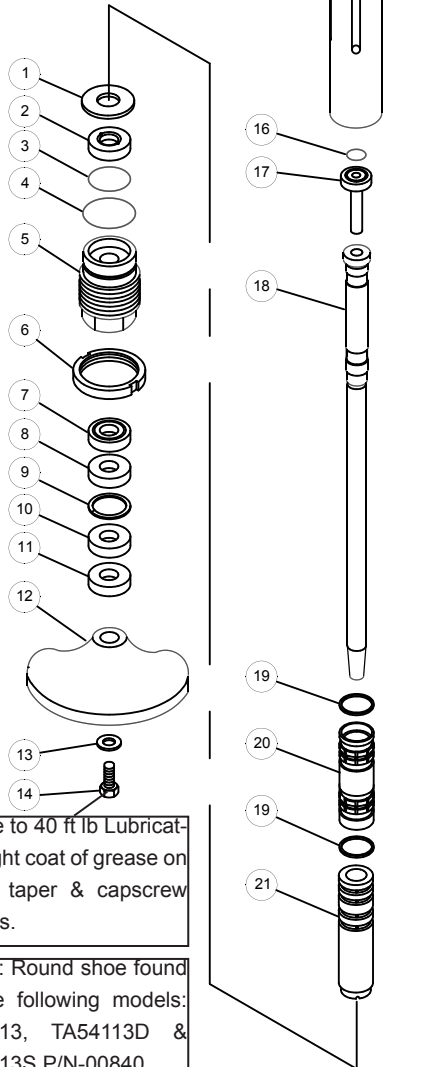

Torque to 40 ft lb Lubricated. Light coat of grease on piston taper & capscrew threads.

NOTE: Round shoe found on the following models: TA54113, TA54113D & TA54113S P/N-00840

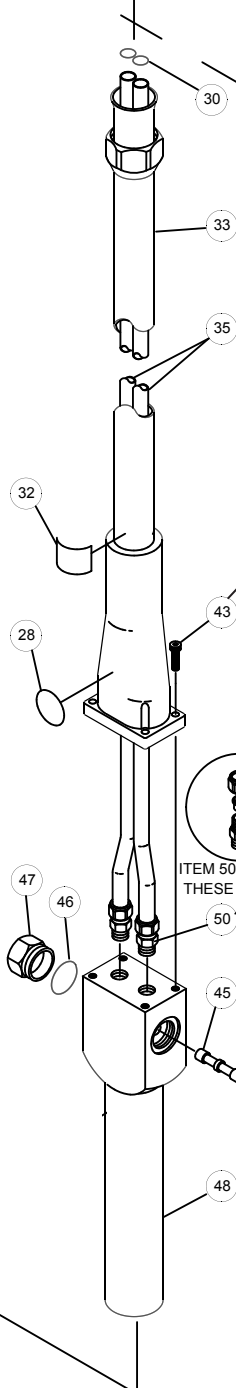
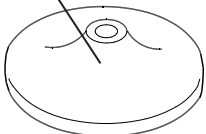

Install with 242  
Loctite & Torque  
to 25 ft lb.

ITEM 50 INCLUDES  
THESE 3 PARTS

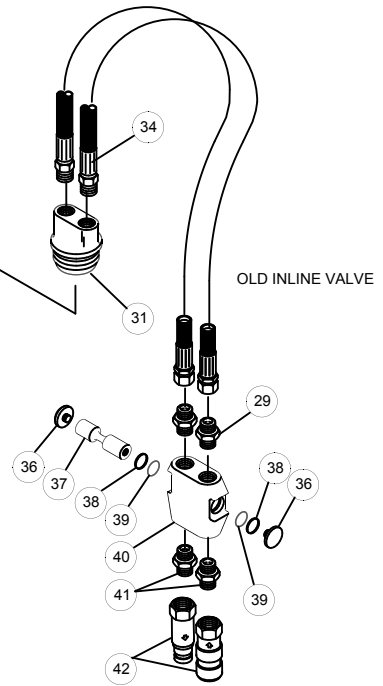

NOTE: IF YOUR INLINE VALVE DOES NOT CONTAIN THIS PART, (SEAL CAP) ORDER INDIVIDUAL PARTS FROM OLD INLINE VALVE.

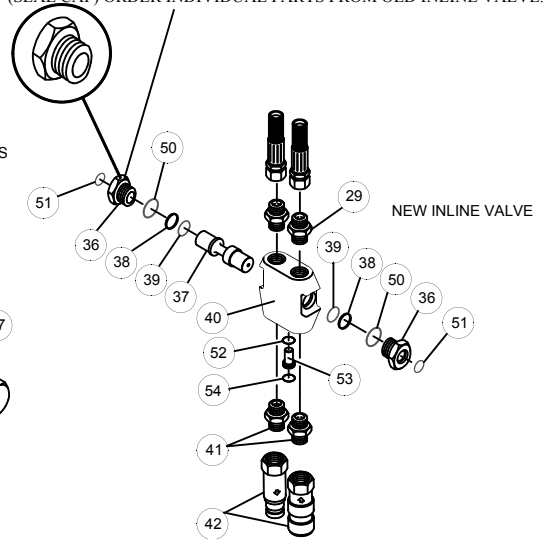

# TA54 PARTS LIST

ITEM	QTY	PART NO.	DESCRIPTION
1	1	01038	THRUST BRIDGE WASHER
2	1	00823	CUSHION
3	1	00834	O-RING
4	1	01262	O-RING
5	1	14883	NOSE
6	1	01795	JAM NUT
7	1	14891	SEAL
8	1	14884	SEAL WASHER
9	1	04902	RETAINING RING, SPIROLOX
10	1	08434	FELT WASHER
11	1	15016	ROD WIPER
12	1	00833	SHOE (KIDNEY)
	1	00840	SHOE ROUND MODELS- TA54113
13	1	00825	LOCKWASHER
14	1	00845	CAPSCREW
15	1	01036	FLOW SLEEVE
16	1	00940	O-RING
17	1	00806	OIL TUBE
18	1	14886	PISTON
19	2	29690	OIL CONTROL SEAL
20	1	00927	BACK SLEEVE
21	1	01037	FRONT SLEEVE
22	1	04525	TRIGGER (TA54103 ONLY)
23	1	00114	ROLL PIN (TA54103 ONLY)
24	1	04097	SPRING (TA54103 ONLY)
25	1	04098	VALVE SPOOL (TA54103 ONLY)
26	1	04523	VALVE BODY ASSY (TA54103 & TA54113 MODELS ONLY)
27	2	07627	O-RING
28	1	14908	NAME TAG
29	2	00856	ADAPTER
30	2	00175	O-RING
31	1	35036	HOSE BLOCK (TA54603 & TA54603A ONLY)
32	1	03783	STICKER, STANLEY LOGO
33	1	07737	HANDLE ASSY (INCL JAM NUT)
34	2	35784	HOSE ASSY (TA54603A ONLY)
35	2	07738	OIL TUBE
36	2	01003	BUTTON (TA54603A ONLY) (OLD INLINE VALVE)
	2	56749	SEAL CAP (NEW INLINE VALVE)
37	1	38631	VALVE SPOOL (TA54603A ONLY) (OLD INLINE VALVE)
	1	67008	VALVE SPOOL (TA54603A ONLY) (NEW INLINE VALVE)

ITEM	QTY	PART NO.	DESCRIPTION
38	2	13568	BACK-UP RING (TA54603A ONLY) (OLD INLINE VALVE)
	2	07224	BACK-UP RING (TA54603A ONLY) (NEW INLINE VALVE)
39	2	13567	O-RING (TA54603A ONLY) (OLD INLINE VALVE)
	2	07626	O-RING (TA54603A ONLY) (NEW INLINE VALVE)
40	1	38629	VALVE BODY ASSY (TA54603A ONLY) (OLD INLINE VALVE)
	1	67007	VALVE BODY ASSY (TA54603A ONLY) (NEW INLINE VALVE)
41	2	00936	ADAPTER (TA54603A ONLY)
42	1	03971	COUPLER SET
43	4	00144	CAPSCREW
44			NO ITEM
45	1	00819	REVERSING SPOOL
46	2	06533	O-RING
47	2	14882	END CAP
		14885	LOWER TAMPER ASSY (INCL ITEMS 1-11, 15-21, & 45-48)
48	1	14889	BLOCK & TUBE ASSY
49			NO ITEM
50	2	01236	TUBE FITTING
51	2	56747	WIPER SEAL
52	1	00026	O-RING
53	1	10536	SELECTOR SCREW
54	1	16070	RETAINING RING
		02030	SEAL KIT—NO VALVE
		02032	SEAL KIT—VALVE IN HANDLE

**LOWER TAMPER ASSY (Includes Items 1-11, 15-21, & 45-48 P/N-14885)**

## Read Before Ordering Inline Valve Parts:

**Inline Valve Assembly (OC-CC) - 72264 (TA54603A)**  
Includes Items (36 thru 40, 50, thru 54)

The inline valve changed around June 2011. To determine if you have the old or new inline valve, see exploded view.

**NOTE:** Individual parts are still available for the older inline valve but if replacing the entire inline valve assy, you must order the new inline valve assy P/N-72264.





# **STANLEY®**

Stanley Hydraulic Tools  
3810 SE Naef Road  
Milwaukie, Oregon 97267-5698 USA  
(503) 659-5660 / Fax (503) 652-1780  
[www.stanleyhydraulics.com](http://www.stanleyhydraulics.com)