

STANLEY

MOUNTED ATTACHMENTS

Selection, Innovation, Performance

Your One-Stop Shop
for Hydraulic Tools
and Attachments



COMPANY OVERVIEW



GREAT BRAND, GREAT TOOLS

STANLEY has a proud tradition of being a global leader in the development of a wide range of innovative hydraulic products used in a variety of industries and applications throughout the world. We at Stanley are dedicated to providing our customers with innovative customer-driven product designs, world class quality, unmatched product support, and superior value.

GLOBAL REPRESENTATION

STANLEY produces an extensive line of products for use in construction, demolition, scrap processing, recycling, utilities, municipalities, railroads, industry, landscaping, underwater, construction, and specialty trades. STANLEY Tools has sales offices and distributors throughout North America, Central America, South America, Europe, Asia, Australia, and the Middle East.

OUR MISSION

STANLEY is committed to providing innovative solutions for infrastructure based applications.

CATALOG INDEX

Mid and Large-Sized Mounted Breakers (MB/XP)	1-2
Small Mounted Breakers (MB)	3-4
Mid-Sized Mounted Breakers (MBX)	5
Drop Hammers (DH)	6
Mounted Compaction (HSX)	7
Suggested Carrier Ranges	8

All STANLEY® tools, accessories, parts and allied equipment are subject to design improvements, specification and price changes at any time without notice and with no obligation to units already sold. Weights, dimensions and operating specifications listed herein are subject to change without notice. Where specifications are critical to your application, please consult the factory.

High Production & Extreme Durability MB/XP Series

When you need low maintenance and high output, you need the MB/XP line.

The MB/XP series is comprised of high production breakers for the most demanding applications. With a wide range of carrier compatibility (from 13 to 80 metric tons) there is a breaker for every job, whether you're doing commercial demolition, road building, quarry work, or production breaking.

Utilizing the industry's most advanced technologies to maximize uptime and increase both efficiency and profitability, the MB/XP line offers superior features as standard:

Membrane Type Accumulator
eliminates time consuming recharging.

Fixed Impact Energy Valve allows
for use on a wider range of carriers.

**Heavy Duty Housings and Wear
Plates** for extreme durability in the harshest
of applications.

Vibration Dampening Tie-Rods
maximizes uptime.

Stroke Selector to increase blow rate and
decrease energy for various applications as
a way to maximize efficiency (applicable for
large-sized breakers only).

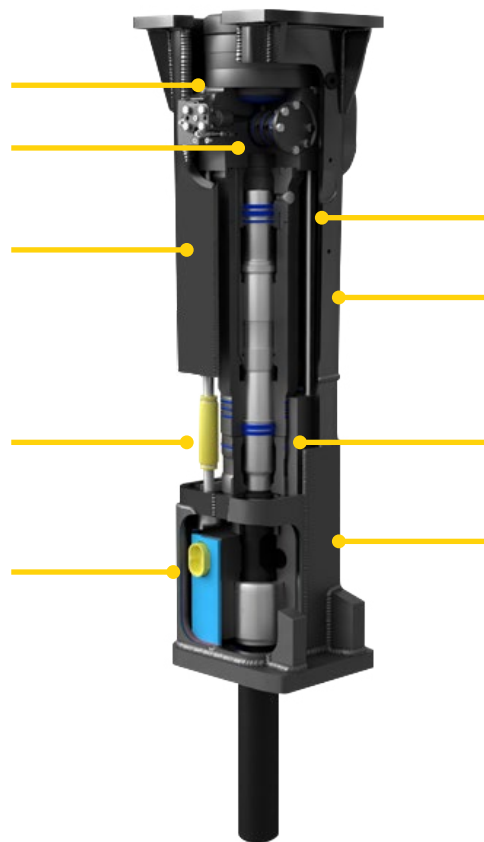

Idle Blow Protector prevents blank firing.

Sound Suppressed Housings dampen operating
volume.

Hydraulic Overflow Protector
for added durability.

**Adapters for Remote Lubricators, and
Air Line** for underwater work.

Autolube & Data Tracker



Good maintenance is critical to your bottom line. That's why auto-lubrication is standard on all MB/XP Series breakers. The breaker-mounted, large capacity lubrication device automatically provides grease to the tool and bushing, so you don't have to.

Also standard on all MB/XP Series breakers is a mounted SDC tracking device. The SDC reader is designed to help operators and service personnel with maintenance planning, service tracking, and accumulated work history.



MB/XP2015

MB/XP2620

MB/XP3025

MB/XP4035

MB/XP5545

MB/XP8055

Mid-Sized

Large-Sized

	Weight		Impact Energy		Impact Rate (BPM)	Tool Diameter		Min Excavator Weight - 3 rd Member	
	lbs	kg	ft-lb	J		Ø in	Ø mm	lbs	m Tons
MB/XP2015	2400	1100	2500	3400	540 - 920	4.5	115	26000	12
MB/XP2620	3100	1400	3500	4700	430 - 790	4.9	125	35000	16
MB/XP3025	3900	1800	5000	6800	450 - 750	5.3	135	46000	21
MB/XP4035	5300	2400	8000	10800	370 - 630	5.6	142	57000	26
MB/XP5545	7500	3400	11000	14900	400 - 560	6.5	166	75000	34
MB/XP8055	10500	4800	13000	17600	370 - 530	7.5	190	95000	43

ACCESSORIES

	MB/XP2015	MB/XP2620	MB/XP3025	MB/XP4035	MB/XP5545	MB/XP8055
CHISEL	76996	78095	78657	78743	79039	79111
LONG CHISEL			78660			
MOIL POINT	76997	78096	78658	78744	79040	79112
LONG MOIL POINT			78661			
BLUNT	76998	78097	78659	78745	79041	79113
LONG BLUNT			78663			
SUPER BLUNT			78666	78749	79045	79117
PYRAMID	76999	78098	78662	78746	79042	79114
HARD ROCK CHISEL			78664	78747	79043	79115
LIMESTONE CHISEL			78665	78748	79044	79116

Specifications and features are subject to change without notice.

Please see order information guide for specific model and ordering information.

Lightweight & Extremely Powerful MB Series



STANLEY knows what you look for in a small mounted breaker, that's why our MB series focuses on simplicity, easy maintenance, and powerful breaking performance. All MB breakers have only two moving parts – which means better performance and less frequent service intervals. At the lower end of the housing, we added steel reinforcement to not only protect the housing, but to protect the power cell and keep operators running longer. A superior valve design allows for a wider range of pressures and flows, lowering stress on components. Plus, the light tool weight contributes to a broader carrier range.

Put all this together and you've got the MB series from STANLEY, it's the small-sized breaker you've been looking for.

Model	Weight		Impact Energy		Impact Rate (BPM)	Tool Diameter		Min Excavator Weight	
	lbs	kg	ft-lbs	J		in.	mm	lbs	m Tons
MB156	173	80	175	240	600 - 1200	1.75	44	1900	1
MB256	493	225	350	475	700 - 1200	2.5	64	4000	2
MB05	480	220	550	745	650 - 1550	2.7	69	5000	2.2
MBF5	465	210	550	745	650 - 1550	2.7	69	5000	2.2
MB556	752	341	750	1015	590 - 1100	2.7	69	7000	3
MB10	750	340	1000	1,355	600 - 1300	3.0	76	7,000	3

ACCESSORIES

	MB156	MB256	MB05	MBF5	MB556	MB10
MOIL POINT						
CONICAL POINT		26259	27281	29863	69863	56547
CROSS CUT CHISEL		26260	27282	29864	69864	56550
LINE CUT CHISEL		26261	27283	69865	69865	56549
BLUNT POINT			27284	69866	69866	56548
ASPHALT CUTTER (LINE CUT)			25171	72912	72912	
ASPHALT CUTTER (CROSS CUT)		26257	25170	72911	72911	
TAMPING PAD ASSEMBLY			69867	69867	56551	70942

Specifications and features are subject to change without notice.

Please see order information guide for specific model and ordering information.

The STANLEY Advantage MB Series

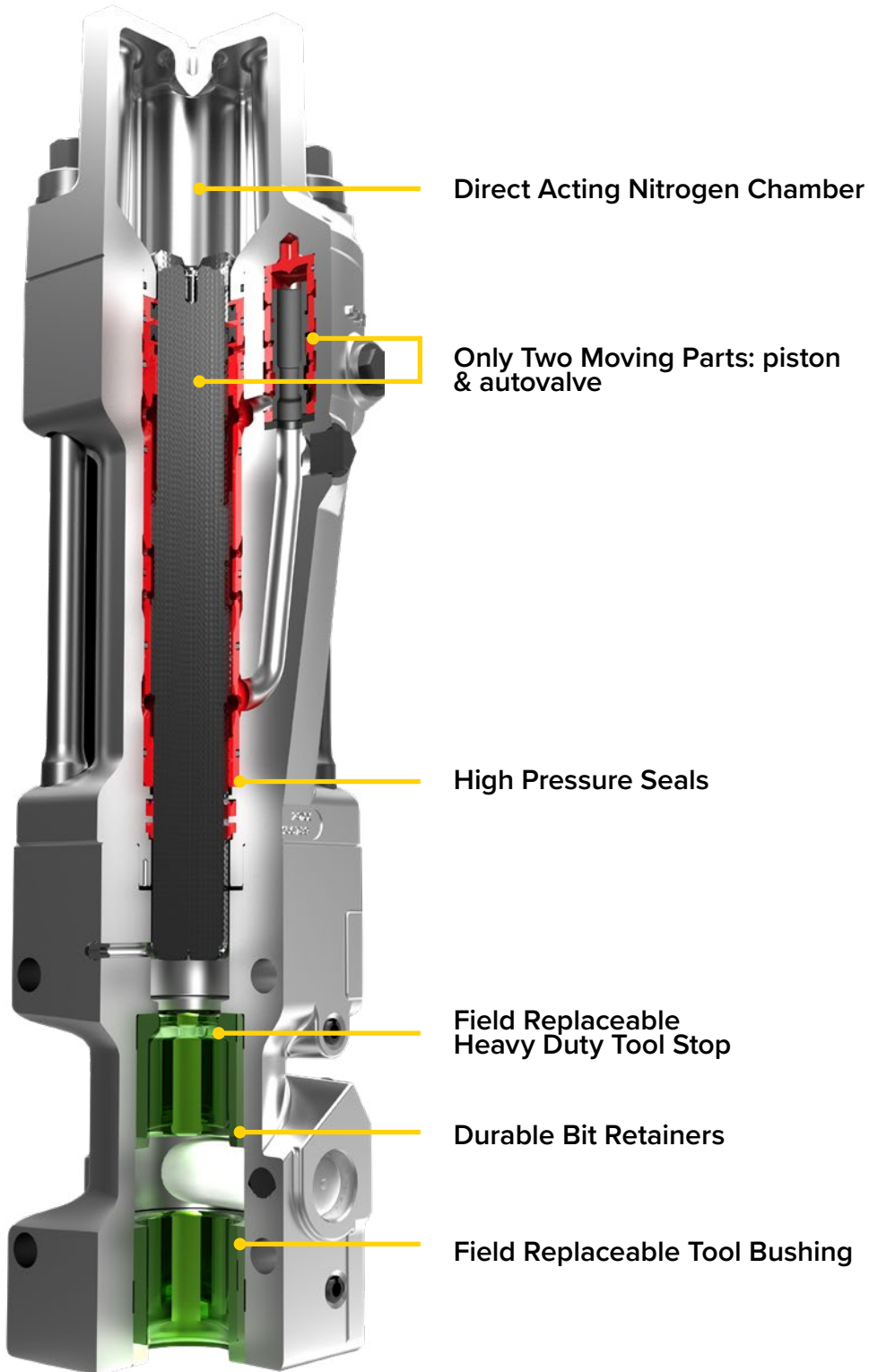

Proven Reliability & Performance MBX Series



STANLEY MBX series breakers feature a patented valve system that dramatically increases the durability and performance of the tool. Less maintenance is required over the life of the breaker because the design has only two moving parts, limiting the need for servicing.

The MB/X series packs serious force and is designed to break a wide array of materials. It's destined to be the tool of choice for demolition, trenching, tunneling, and boulder breaking. Packed with power and ready to ship – the MB/X series offers years of worry-free breaking performance.

Model	Weight		Impact Energy		Impact Rate (BPM)	Tool Diameter		Min Excavator Weight - 3rd Member	
	lbs	kg	lbs	kg		in	mm	lbs	m Tons
MBX15	1200	540	1,500	2030	400 - 800	3.3	85	14000	6
MBX138	2270	1029	2,000	2700	450 - 630	3.9	100	19800	9
MBX208	3080	1397	3,000	4000	400 - 530	4.9	125	26000	12
MBX258	3740	1696	4,000	5400	350 - 600	5.3	135	35200	16
MBX308	4275	1939	5,000	6800	400 - 490	5.5	140	39600	18

ACCESSORIES

	MBX15	MBX138	MBX208	MBX258	MBX308
MOIL POINT	71627	71634	71648	71659	71669
CONICAL POINT	71623		71644	71655	71666
CROSS CUT CHISEL	71624	71631	71645	71656	71667
LINE CUT CHISEL	71625	71632	71646	71657	71668
BLUNT POINT	71726	71633	71647	71658	71669

Specifications and features are subject to change without notice.

Please see order information guide for specific model and ordering information.

Demolition & Recycling DH Series



The Cyclone Drop Hammer was developed specifically for the demolition of concrete flat-work allowing for easier removal in smaller and more manageable sizes. This enables reducing the size of the excavator required if pulling up the slab, better compaction for stock-piling and transportation, and smaller material handling for crusher feed.

Up to 5X More Power to Weight than conventional hydraulic breakers.

Less Maintenance with no upper or lower bushings to grease or replace, no accumulators to re-charge, and no wear plates to rebuild or replace.

Reduced Carrier Wear and Operator Fatigue the hammer is designed to have the tool rest directly on the concrete surface. This ensures that the impact load is transmitted squarely down to the concrete.

Model	Weight		Impact Energy		Blows Per Minute	Skid Steer Operating Load Rating		Excavator Machine Weight		Concrete Thickness	
	lbs	kg	ft-lbs	j		lbs	kg	lbs	mT	in	cm
DH3500	1750	794	3500	4746	32	1750	800	15400	7	8-10	20-25
DH9000	3150	1429	9000	12200	23	3150	1400	26500	12	12-15	30-38

ACCESSORIES

Model	Part No.	Description	Weight
DH3500	DH3500	3,500 FT LBS / 4,746 NM, 32 BLOWS PER MINUTE DROP HAMMER WITH SKID STEER MOUNTING BRACKET	1,750 LBS / 794 KG
DH9000	DH9000	9,000 FT LBS / 12,200 NM, 23 BLOWS PER MINUTE DROP HAMMER WITH SKID STEER MOUNTING BRACKET	3,150 LBS / 1,429 KG

Specifications and features are subject to change without notice.

Please see order information guide for specific model and ordering information.

Maximum Vibratory Force HSX Series



Use your skid-steer loader, backhoe, or excavator as an effective compacting machine capable of far greater performance and versatility than handheld tools. In addition to compacting, the STANLEY HSX line of mounted compactors is designed for driving piles, posts, and pipe.

Flexibility

Wide range of mounting options are available for pin-on, skid-steer, or quick coupler configurations.

Protection

Remote mounted flow control maintains optimal motor RPM. The cross check valve manages surges and protects against accidental flow mishaps.

Reliability

Direct mounted splined motor shaft eliminates a connection point at the eccentric assembly.

Time-Savings

Modular design enables quick access to components, decreasing downtime and operational costs.

Durability





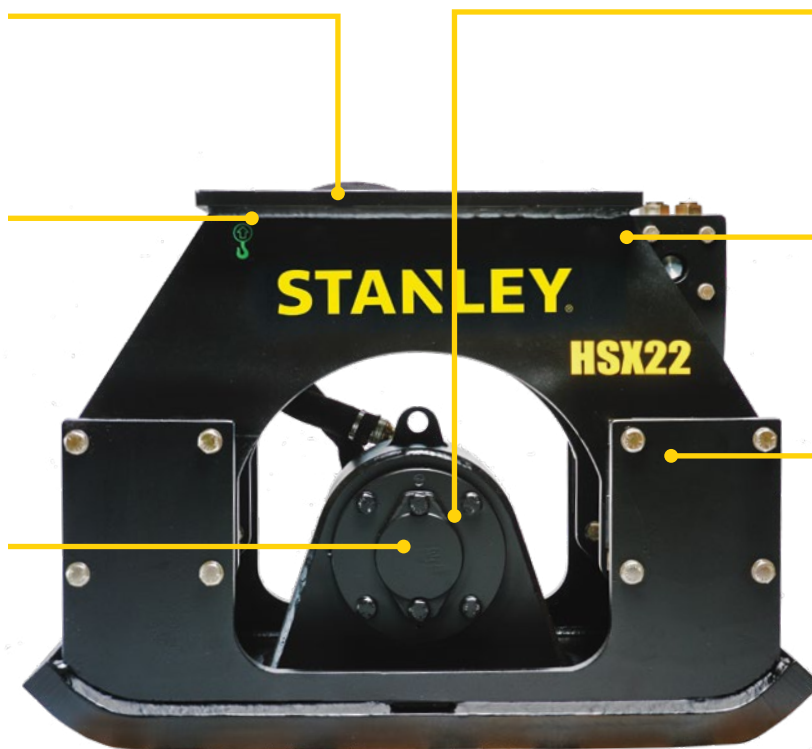

Rugged box construction design withstands the harsh loading condition that offers trouble-free service.





Compact















Unique frame construction provides a low profile design that enables four elastomer shock mounts located at each corner to distribute the vibration across the foot plate evenly.



Model	Weight		Vibrations Per Minute	Centrifugal Force		Baseplate Size		Carrier Weight Class	
	lbs	kg		lbs	kg	in	mm	lbs	kg
HSX3	370	168	2100	3440	1542	18.8 x 20	442 x 508	5000 - 13000	2200 - 5900
HSX6	850	386	2000	6400	2902	23.5 x 26	600 x 660	9000 - 30000	4000 - 13600
HSX11	1,425	646	2000	11350	5147	27 x 30	686 x 762	16200 - 55000	7200 - 25000
HSX22	2,200	998	2100	22000	10000	32 x 42	813 x 1067	54000 - 142000	24500 - 65000

MB/XP BREAKERS Carrier Ranges CARRIER RANGE IN METRIC TONS																
MODELS	5	10	15	20	25	30	35	40	45	50	55	60	65	70	75	80
MB/XP2015																
MB/XP2620																
MB/XP3025																
MB/XP4035																
MB/XP5545																
MB/XP8055																

MBX BREAKERS Carrier Ranges CARRIER RANGE IN METRIC TONS																
MODELS	5	10	15	20	25	30	35	40	45	50	55	60	65	70	75	80
MBX15																
MBX138																
MBX208																
MBX258																
MBX308																

MB BREAKERS Carrier Ranges CARRIER RANGE IN LBS																
MODELS	0	2000	4000	6000	8000	10,000	12000	14000	16000	18000	20000	22000	24000	26000	28000	30000
MB156																
MB256																
MB05/MBF5																
MB556																
MB10																

**SELECTION.
INNOVATION.
PERFORMANCE.**



STANLEY®