

STANLEY®

RD12 HYDRAULIC RAIL DRILL



USER MANUAL Safety, Operation and Maintenance



© 2014 STANLEY Black & Decker, Inc.
New Britain, CT 06053
U.S.A.
32515 11/2018 Ver. 22

DECLARATION OF CONFORMITY

DECLARATION OF CONFORMITY
ÜBEREINSTIMMUNGS-ERKLÄRUNG
DECLARATION DE CONFORMITE CEE
DECLARACION DE CONFORMIDAD
DICHIARAZIONE DI CONFORMITA

STANLEY
Infrastructure
CE

I, the undersigned:
Ich, der Unterzeichnende:
Je soussigné:
El abajo firmante:
Io sottoscritto:

Nuerenberg, David

Surname and First names/Familiennname und Vornamen/Nom et prénom/Nombre y apellido/Cognome e nome

hereby declare that the equipment specified hereunder:
bestätige hiermit, daß erklaren Produkt genannten Werk oder Gerät:
déclare que l'équipement visé ci-dessous:
Por la presente declaro que el equipo se especifica a continuación:
Dichiaro che le apparecchiature specificate di seguito:

- Category: **Rail Drill, Hydraulic**
Kategorie:
Catégorie:
Categoria:
Categoria:
- Make/Marke/Marque/Marca/Marca **STANLEY**
- Type/Typ/Type/Tipo/Tipo: **RD12101, RD12100**
- Serial number of equipment:
Seriennummer des Geräts:
Numéro de série de l'équipement:
Numero de serie del equipo:
Matricola dell'attrezzatura:
All

Has been manufactured in conformity with
Wurde hergestellt in Übereinstimmung mit
Est fabriqué conformément
Ha sido fabricado de acuerdo con
E' stata costruita in conformità con

Directive/Standards Richtlinie/Standards Directives/Normes Directriz/Los Normas Direttiva/Norme	No. Nr Numéro No n.	Approved body Prüfung durch Organisme agréé Aprobado Collaudato
EN ISO EN ISO Machinery Directive	3744 13732-1 2006/42/EC	Self Self Self

- Special Provisions: **None**
Spezielle Bestimmungen:
Dispositions particulières:
Provisiones especiales:
Disposizioni speciali:
- Representative in the Union: **Patrick Vervier, Stanley Dubuis 17-19, rue Jules Berthonneau-BP 3406 41034 Blois Cedex, France.**
Vertreter in der Union/Représentant dans l'union/Representante en la Union/Rappresentante presso l'Unione

Done at/Ort/Fait à/Dado en/Fatto a STANLEY Infrastructure, Milwaukie, Oregon USA Date/Datum/le/Fecha/Data 4/26/2018

Signature/Unterschrift/Signature/Firma/Firma

Position/Position/Fonction/Cargo/Posizione North America Quality Manager

TABLE OF CONTENTS

SAFETY SYMBOLS.....	4
SAFETY PRECAUTIONS	5
TOOL STICKERS & TAGS	6
HOSE TYPES	7
HOSE RECOMMENDATIONS.....	8
HTMA / EHTMA REQUIREMENTS	9
OPERATION	10
TEMPLATES & HOLE GUIDES	12
TOOL PROTECTION & CARE.....	15
TROUBLESHOOTING	16
SPECIFICATIONS	17
RD12 PARTS ILLUSTRATION.....	18
RD12 PARTS LIST.....	19

IMPORTANT

To fill out a product warranty validation form, and for information on your warranty, visit www.stanleyinfrastructure.com and select the Company tab > Warranty.

Note: The warranty validation record must be submitted to validate the warranty.

SERVICING: This manual contains safety, operation and routine maintenance instructions. STANLEY Infrastructure recommends that servicing of hydraulic tools, other than routine maintenance, must be performed by an authorized and certified dealer. Please read the following warning.

⚠ WARNING

SERIOUS INJURY OR DEATH COULD RESULT FROM THE IMPROPER REPAIR OR SERVICE OF THIS TOOL.

REPAIRS AND / OR SERVICE TO THIS TOOL MUST ONLY BE DONE BY AN AUTHORIZED AND CERTIFIED DEALER.

For the nearest certified dealer, call STANLEY Infrastructure at (503) 659-5660 and ask for a Customer Service Representative.

SAFETY SYMBOLS

Safety symbols and signal words, as shown below, are used to emphasize all operator, maintenance and repair actions which, if not strictly followed, could result in a life-threatening situation, bodily injury or damage to equipment.



This is the safety alert symbol. It is used to alert you to potential personal injury hazards. Obey all safety messages that follow this symbol to avoid possible injury or death.



This safety alert and signal word indicates an imminently hazardous situation which, if not avoided, will result in death or serious injury.



This safety alert and signal word indicates a potentially hazardous situation which, if not avoided, could result in death or serious injury.



This safety alert and signal word indicates a potentially hazardous situation which, if not avoided, could result in death or serious injury.



This signal word indicates a potentially hazardous situation which, if not avoided, may result in property damage.



This signal word indicates a situation which, if not avoided, will result in damage to the equipment.



This signal word indicates a situation which, if not avoided, may result in damage to the equipment.

Always observe safety symbols. They are included for your safety and for the protection of the tool.

LOCAL SAFETY REGULATIONS

Enter any local safety regulations here. Keep these instructions in an area accessible to the operator and maintenance personnel.

Tool operators and maintenance personnel must always comply with the safety precautions given in this manual and on the stickers and tags attached to the tool and hose.

These safety precautions are given for your safety. Review them carefully before operating the tool and before performing general maintenance or repairs.

Supervising personnel should develop additional precautions relating to the specific work area and local safety regulations. If so, place the added precautions in the space provided in this manual.

The model RD12 Hydraulic Rail Drill will provide safe and dependable service if operated in accordance with the instructions given in this manual. Read and understand this manual and any stickers and tags attached to the pressure washer and hose before operation. Failure to do so could result in personal injury or equipment damage.



SAFETY PRECAUTIONS

- The operator must start in a work area without bystanders. Flying debris can cause serious injury.
- Do not operate the tool unless thoroughly trained or under the supervision of an instructor. Establish a training program for all operators to ensure safe operation.
- Always wear personal protection equipment (PPE) such as goggles, safety shoes, head, eye, breathing, and ear protection when operating the tool. Use gloves and aprons when necessary.
- The operator must be familiar with all prohibited work areas such as excessive slopes and dangerous terrain conditions.
- Do not inspect, clean or replace the drill bit or any part(s) if the hydraulic power source is connected. Do not inspect or clean the tool while the hydraulic power source is connected. Accidental engagement of the tool can cause serious injury.
- Always connect hoses to the tool hose couplers before energizing the hydraulic power source. Be sure all hose connections are tight and are in good condition.
- Do not operate the tool at oil temperatures above 140° F/60° C. Operation at higher temperatures can cause higher than normal temperatures at the tool which can result in operator discomfort.
- Never wear loose clothing or unrestrained long hair that can get entangled in the working parts of the tool.
- To avoid personal injury or equipment damage, all tool repair, maintenance and service must only be performed by authorized and properly trained personnel.
- The hydraulic circuit control valve must be in the OFF position when coupling or uncoupling the tool. Wipe all couplers clean before connecting. Failure to do so may result in damage to the quick couplers and cause overheating. Use only lint-free cloths.
- Never transport or carry the tool with the unit energized.
- Use proper lifting techniques when handling the tool. Do not overreach. Maintain proper footing and balance at all times.
- Keep hands and fingers away from rotating parts.
- Do not operate a damaged, improperly adjusted or incompletely assembled tool.
- Do not exceed the rated limits of the tool or use the tool for applications beyond its design capacity.
- Always keep critical tool markings, such as labels and warning stickers legible.
- Check fasteners tightness often and before each use daily.
- Never operate the tool if you cannot be sure that underground utilities are not present. Underground electrical utilities present an electrocution hazard. Underground gas utilities present an explosion hazard. Other underground utilities may present other hazards.
- Always replace parts with replacement parts recommended by STANLEY.
- Warning: hydraulic fluid under pressure could cause skin injection injury. If you are injured by hydraulic fluid get medical attention immediately.
- **WARNING:** Some dust created by power sanding, sawing, grinding, drilling, and other construction activities contains chemicals known to the State of California to cause cancer, birth defects or other reproductive harm. Some examples of these chemicals are:
 - Lead from lead-based paints,
 - crystalline silica from bricks and cement and other masonry products, and
 - arsenic and chromium from chemically-treated lumber.

Your risk from these exposures varies, depending on how often you do this type of work. To reduce your exposure to these chemicals: work in a well ventilated area, and work with approved safety equipment, such as those dust masks that are specially designed to filter out microscopic particles.

Protect yourself and those around you. Research and understand the materials you are cutting. Follow correct safety procedures and comply with all applicable national, state or provisional health and safety regulations relating to them, including, if appropriate arranging for the safe disposal of the materials by a qualified person.

TOOL STICKERS & TAGS



11207
Circuit Type D
Sticker



28788
Manual
Sticker



81441
Sound Power
Sticker



31096
RD12 Model Sticker

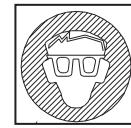

31049
Eye Protection Sticker

STANLEY RAILROAD HELP DESK
1-800-549-0517
FOR CUSTOMER SERVICE OR
TECHNICAL QUESTIONS

73680
Railroad Help Desk Sticker

WARNING
PINCH POINT
STAY CLEAR OF ALL MOVING PARTS

17572
Pinch Point Warning Sticker

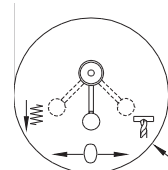

31096
RD12 Model Sticker

STANLEY	Stanley Hydraulic Tools 3810 SE Noef Rd Milwaukie, Oregon 97267 U.S.A.
	Model No. RD12
	7-10 gpm/26-38 lpm 2500 psi/172 bar 900 rpm

P/N 74765

74765
RD12 Model Sticker

NOTE:
THE INFORMATION LISTED
ON THE STICKERS SHOWN,
MUST BE LEGIBLE AT ALL
TIMES.

REPLACE DECALS IF
THEY BECOME WORN OR
DAMAGED. REPLACEMENTS
ARE AVAILABLE FROM
YOUR LOCAL STANLEY
DISTRIBUTOR.

The safety tag (P/N 15875) at right is attached to the tool when shipped from the factory. Read and understand the safety instructions listed on this tag before removal. We suggest you retain this tag and attach it to the tool when not in use.

DANGER

1. FAILURE TO USE HYDRAULIC HOSE LABELED AND CERTIFIED AS NON-CONDUCTIVE WHEN USING HYDRAULIC TOOLS ON OR NEAR ELECTRICAL LINES MAY RESULT IN DEATH OR SERIOUS INJURY.

BEFORE USING HOSE LABELED AND CERTIFIED AS NON-CONDUCTIVE ON OR NEAR ELECTRICAL LINES BE SURE THE HOSE IS MAINTAINED AS NON-CONDUCTIVE. THE HOSE SHOULD BE REGULARLY TESTED FOR ELECTRIC CURRENT LEAKAGE IN ACCORDANCE WITH YOUR SAFETY DEPARTMENT INSTRUCTIONS.

2. A HYDRAULIC LEAK OR BURST MAY CAUSE OIL INJECTION INTO THE BODY OR CAUSE OTHER SEVERE PERSONAL INJURY.

A. **DO NOT** EXCEED SPECIFIED FLOW AND PRESSURE FOR THIS TOOL. EXCESS FLOW OR PRESSURE MAY CAUSE A LEAK OR BURST.

B. **DO NOT** EXCEED RATED WORKING PRESSURE OF HYDRAULIC HOSE USED WITH THIS TOOL. EXCESS PRESSURE MAY CAUSE A LEAK OR BURST.

C. CHECK TOOL HOSE COUPLERS AND CONNECTORS DAILY FOR LEAKS. **DO NOT** FEEL FOR LEAKS WITH YOUR HANDS. CONTACT WITH A LEAK MAY RESULT IN SEVERE PERSONAL INJURY.

IMPORTANT

READ OPERATION MANUAL AND SAFETY INSTRUCTIONS FOR THIS TOOL BEFORE USING IT.

USE ONLY PARTS AND REPAIR PROCEDURES APPROVED BY STANLEY AND DESCRIBED IN THE OPERATION MANUAL.

TAG TO BE REMOVED ONLY BY TOOL OPERATOR.

SEE OTHER SIDE

DANGER

D. **DO NOT** LIFT OR CARRY TOOL BY THE HOSES. **DO NOT** ABUSE HOSE. **DO NOT** USE KINKED, TORN OR DAMAGED HOSE.

3. **MAKE SURE** HYDRAULIC HOSES ARE PROPERLY CONNECTED TO THE TOOL BEFORE PRESSURING SYSTEM. SYSTEM PRESSURE HOSE MUST ALWAYS BE CONNECTED TO TOOL "IN" PORT. SYSTEM RETURN HOSE MUST ALWAYS BE CONNECTED TO TOOL "OUT" PORT. REVERSING CONNECTIONS MAY CAUSE REVERSE TOOL OPERATION WHICH CAN RESULT IN SEVERE PERSONAL INJURY.

4. **DO NOT** CONNECT OPEN-CENTER TOOLS TO CLOSED-CENTER HYDRAULIC SYSTEMS. THIS MAY RESULT IN LOSS OF OTHER HYDRAULIC FUNCTIONS POWERED BY THE SAME SYSTEM AND/OR SEVERE PERSONAL INJURY.

5. **BYSTANDERS** MAY BE INJURED IN YOUR WORK AREA. **KEEP BYSTANDERS** CLEAR OF YOUR WORK AREA.

6. **WEAR** HEARING, EYE, FOOT, HAND AND HEAD PROTECTION.

7. **TO AVOID** PERSONAL INJURY OR EQUIPMENT DAMAGE, ALL TOOL REPAIR MAINTENANCE AND SERVICE MUST ONLY BE PERFORMED BY AUTHORIZED AND PROPERLY TRAINED PERSONNEL.

IMPORTANT

READ OPERATION MANUAL AND SAFETY INSTRUCTIONS FOR THIS TOOL BEFORE USING IT.

USE ONLY PARTS AND REPAIR PROCEDURES APPROVED BY STANLEY AND DESCRIBED IN THE OPERATION MANUAL.

TAG TO BE REMOVED ONLY BY TOOL OPERATOR.

SEE OTHER SIDE

SAFETY TAG P/N 15875 (Shown smaller than actual size)

HOSE TYPES

The rated working pressure of the hydraulic hose must be equal to or higher than the relief valve setting on the hydraulic system. There are three types of hydraulic hose that meet this requirement and are authorized for use with STANLEY hydraulic tools. They are:

Certified non-conductive — constructed of thermoplastic or synthetic rubber inner tube, synthetic fiber braid reinforcement, and weather resistant thermoplastic or synthetic rubber cover. *Hose labeled **certified non-conductive** is the only hose authorized for use near electrical conductors.*

Wire-braided (conductive) — constructed of synthetic rubber inner tube, single or double wire braid reinforcement, and weather resistant synthetic rubber cover. *This hose is **conductive** and must never be used near electrical conductors.*

Fabric-braided (not certified or labeled non-conductive) — constructed of thermoplastic or synthetic rubber inner tube, synthetic fiber braid reinforcement, and weather resistant thermoplastic or synthetic rubber cover. *This hose is **not certified non-conductive** and must never be used near electrical conductors.*

HOSE SAFETY TAGS

To help ensure your safety, the following DANGER tags are attached to all hose purchased from STANLEY. DO NOT REMOVE THESE TAGS.

If the information on a tag is illegible because of wear or damage, replace the tag immediately. A new tag may be obtained from your STANLEY Distributor.

THE TAG SHOWN BELOW IS ATTACHED TO “CERTIFIED NON-CONDUCTIVE” HOSE

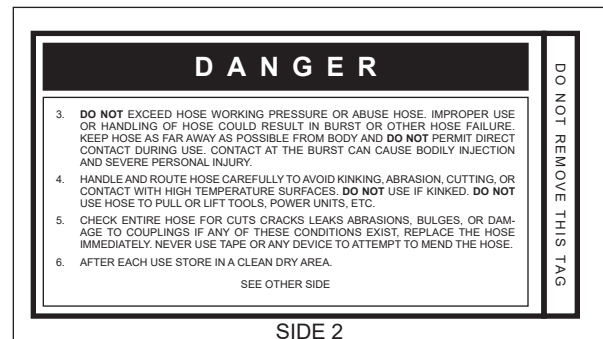
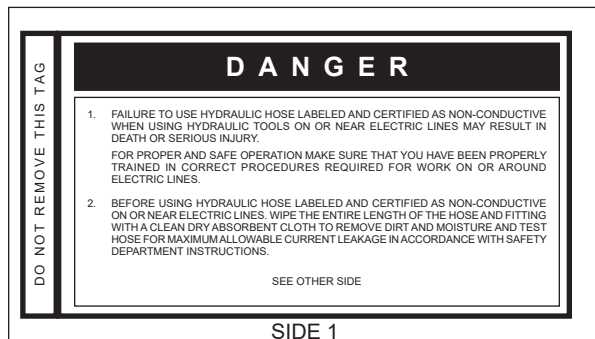

(Shown smaller than actual size)

THE TAG SHOWN BELOW IS ATTACHED TO “CONDUCTIVE” HOSE.

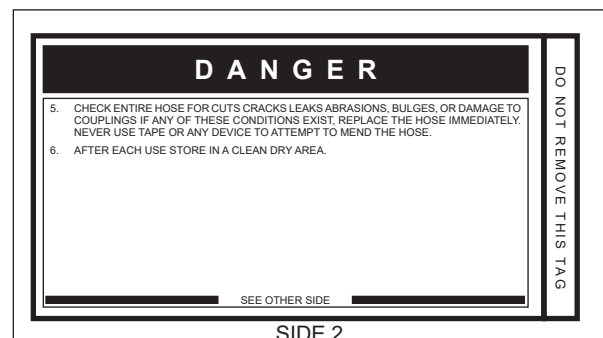
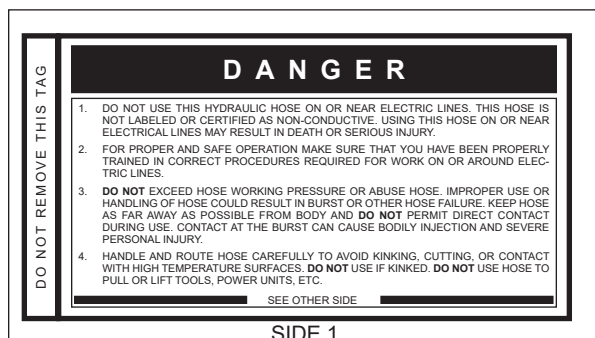

(Shown smaller than actual size)

HOSE RECOMMENDATIONS

Tool to Hydraulic Circuit Hose Recommendations

The chart to the right shows recommended minimum hose diameters for various hose lengths based on gallons per minute (GPM)/liters per minute (LPM). These recommendations are intended to keep return line pressure (back pressure) to a minimum acceptable level to ensure maximum tool performance.

This chart is intended to be used for hydraulic tool applications only based on STANLEY tool operating requirements and should not be used for any other applications.

All hydraulic hose must have at least a rated minimum working pressure equal to the maximum hydraulic system relief valve setting.

All hydraulic hose must meet or exceed specifications as set forth by SAE J517.

Oil Flow		Hose Lengths		Inside Diameter		USE (Press/Return)	Min. Working Pressure	
GPM	LPM	FEET	METERS	INCH	MM		PSI	BAR
Certified Non-Conductive Hose - Fiber Braid - for Utility Bucket Trucks								
4-9	15-34	up to 10	up to 3	3/8	10	Both	2250	155
Conductive Hose - Wire Braid or Fiber Braid - DO NOT USE NEAR ELECTRICAL CONDUCTORS								
4-6	15-23	up to 25	up to 7.5	3/8	10	Both	2500	175
4-6	15-23	26-100	7.5-30	1/2	13	Both	2500	175
5-10.5	19-40	up to 50	up to 15	1/2	13	Both	2500	175
5-10.5	19-40	51-100	15-30	5/8	16	Both	2500	175
5-10.5	19-40	100-300	30-90	5/8	16	Pressure	2500	175
10-13	38-49	up to 50	up to 15	3/4	19	Return	2500	175
10-13	38-49	51-100	15-30	5/8	16	Both	2500	175
10-13	38-49	100-200	30-60	3/4	19	Return	2500	175
13-16	49-60	up to 25	up to 8	1	25.4	Pressure	2500	175
13-16	49-60	26-100	8-30	5/8	16	Return	2500	175
13-16	49-60	26-100	8-30	3/4	19	Pressure	2500	175
13-16	49-60	26-100	8-30	3/4	19	Return	2500	175
13-16	49-60	26-100	8-30	1	25.4	Return	2500	175

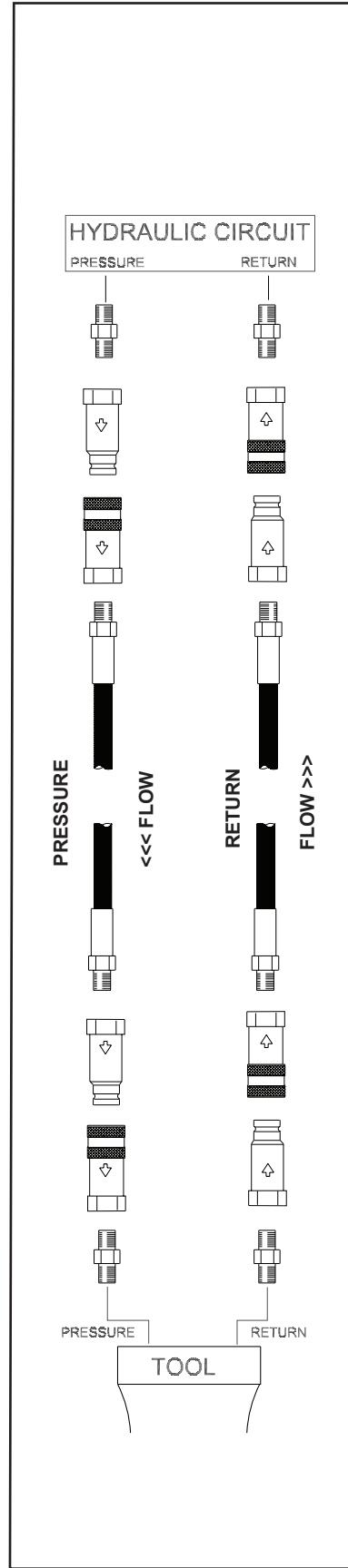

Figure 1. Typical Hose Connections





HTMA / EHTMA REQUIREMENTS

HTMA / EHTMA REQUIREMENTS

TOOL TYPE

HTMA HYDRAULIC SYSTEM REQUIREMENTS	TYPE I	TYPE II	TYPE RR	TYPE III
Flow range	4-6 GPM (15-23 LPM)	7-9 GPM (26-34 LPM)	9-10.5 GPM (34-40 LPM)	11-13 GPM (42-49 LPM)
Nominal operating pressure (At the power supply outlet)	1500 psi (103 bar)	1500 psi (103 bar)	1500 psi (103 bar)	1500 psi (103 bar)
System relief valve setting (At the power supply outlet)	2100-2250 psi (145-155 bar)	2100-2250 psi (145-155 bar)	2200-2300 psi (152-159 bar)	2100-2250 psi (145-155 bar)
Maximum back pressure (At tool end of the return hose)	250 psi (17 bar)	250 psi (17 bar)	250 psi (17 bar)	250 psi (17 bar)
Measured at a max fluid viscosity of: (At minimum operating temperature)	400 ssu* (82 centistokes)	400 ssu* (82 centistokes)	400 ssu* (82 centistokes)	400 ssu* (82 centistokes)
Temperature: Sufficient heat rejection capacity to limit maximum fluid temperature to: (At maximum expected ambient temperature)	140° F (60° C)	140° F (60° C)	140° F (60° C)	140° F (60° C)
Minimum cooling capacity at a temperature difference of between ambient and fluid temps	3 hp (2.24 kW) 40° F (22° C)	5 hp (3.73 kW) 40° F (22° C)	6 hp (5.22 kW) 40° F (22° C)	7 hp (4.47 kW) 40° F (22° C)
Note: Do not operate the tool at oil temperatures above 140° F (60° C). Operation at higher temperatures can cause operator discomfort at the tool.				
Filter minimum full-flow filtration Sized for flow of at least: (For cold temp startup and maximum dirt-holding capacity)	25 microns 30 GPM (114 LPM)	25 microns 30 GPM (114 LPM)	25 microns 30 GPM (114 LPM)	25 microns 30 GPM (114 LPM)
Hydraulic fluid, petroleum based (premium grade, anti- wear, non-conductive) Viscosity (at minimum and maximum operating temps)	100-400 ssu (20-82 centistokes)	100-400 ssu (20-82 centistokes)	100-400 ssu (20-82 centistokes)	100-400 ssu (20-82 centistokes)
Note: When choosing hydraulic fluid, the expected oil temperature extremes that will be experienced in service determine the most suitable temperature viscosity characteristics. Hydraulic fluids with a viscosity index over 140 will meet the requirements over a wide range of operating temperatures.				
*SSU = Saybolt Seconds Universal				

CLASSIFICATION

EHTMA HYDRAULIC SYSTEM REQUIREMENTS					
Flow range	3.5-4.3 GPM (13.5-16.5 LPM)	4.7-5.8 GPM (18-22 LPM)	7.1-8.7 GPM (27-33 LPM)	9.5-11.6 GPM (36-44 LPM)	11.8-14.5 GPM (45-55 LPM)
Nominal operating pressure (At the power supply outlet)	1870 psi (129 bar)	1500 psi (103 bar)	1500 psi (103 bar)	1500 psi (103 bar)	1500 psi (103 bar)
System relief valve setting (At the power supply outlet)	2495 psi (172 bar)	2000 psi (138 bar)	2000 psi (138 bar)	2000 psi (138 bar)	2000 psi (138 bar)

Note: These are general hydraulic system requirements. See tool specification page for tool specific requirements.

OPERATION

PRE OPERATION PROCEDURES

PREPARATION FOR INITIAL USE

The tool as shipped has no special unpacking or assembly requirements prior to usage. Inspection to assure the tool was not damaged in shipping and that it does not contain packing debris is all that is required. Otherwise, the tool may be connected to a hydraulic source upon receipt.

CHECK HYDRAULIC POWER SOURCE

1. Using a calibrated flowmeter and pressure gauge, check that the hydraulic power source develops a flow of 8–10 gpm/30–38 lpm at 2000 psi/140 bar.
2. Make certain the hydraulic power source is equipped with a relief valve set to open at 2200–2300 psi/152–159 bar maximum.
3. Make certain that the power source return pressure does not exceed 250 psi/17 bar.

CONNECT HOSES

1. Wipe all hose couplers with a clean lint-free cloth before making connections.
2. Connect the hoses from the hydraulic power source to the hose couplers on the tool. It is a good practice to connect the return hose first and disconnect it last to minimize or avoid trapped pressure within the tool.
3. Observe flow indicators stamped on hose couplers to be sure that oil will flow in the proper direction. The female coupler is the inlet coupler.
4. Observe the **IN** and **OUT** port lettering on the valve block assembly to ensure that the hydraulic flow is in the proper direction. The IN port lettering indicates the inlet (pressure) side.

NOTE:

The pressure increase in uncoupled hoses left in the sun may result in making them difficult to connect. When possible, connect the free ends of operating hoses together.

USING COOLANT

The RD12 rail drill is equipped with a separate coolant can assembly that is used to deliver coolant to the drill bit. Follow the instructions below to use the coolant can assembly with the rail drill:

1. If operating the rail drill at temperatures above 32 °F/0 °C, fill the coolant can with ordinary tap water.

2. If operating the rail drill at temperatures below 32 °F/0 °C, fill the coolant can with a mixture of 50% ordinary tap water and 50% biodegradable antifreeze.
3. Pressurize the coolant can using the carrying handle/pump.
4. Connect the coolant can assembly to the rail drill using the supplied quick-disconnect coupler.

OPERATING PROCEDURES

1. Observe all safety precautions.
2. Make sure the drill bit you intend to use contains carbide inserts with good cutting surfaces. If the surfaces are worn or chipped, unscrew the retaining screw and rotate the insert to a good cutting surface. If the inserts do not contain a good cutting surface on one of the four sides, replace the inserts. Make sure the bit holder is not damaged.
3. Install the drill bit into the piston machining assembly (24) and then turn it clockwise until it stops.

RAIL TEMPLATES & HOLE GUIDES

NOTE:

The RD12 must be used with rail templates and hole guides. See the chart at the end of this section for selections of rail templates and hole guides.

1. Install a hole guide assembly onto the rail and position it where you want to drill.
2. Install templates onto the rail drill with the rail size facing the rail.

NOTE:

To avoid drill bit damage, make sure the drill bit/piston assembly is fully retracted prior to placing the RD12 on the rail.

3. Set the rail drill over the hole guide on the rail so that the templates are nested between the ball and the base of the rail and the adjustment screw (52) fits in a slot in the hole guide.
4. Adjust the threaded shaft (44) until there is no movement of the rail drill as it sits on the rail and the hole guide. Wiggle the RD12 to remove all looseness. Then lift the handle (49) up and turn the threaded shaft (44) clockwise approximately 1/2 turn. Push the handle (49) down hard to firmly clamp the RD12 to the rail.

OPERATION

TO BEGIN DRILLING

NOTE:

Do not operate the drill in the fully advanced position for more than 5-10 seconds at one time.

1. Engage the control valve on the hydraulic power source to the ON position.
2. To begin drilling, move the control lever on the rail drill toward the “drill bit” symbol. The drill bit will turn and advance simultaneously. Make sure water is spraying from the bit.

TO STOP DRILLING

Move the control lever to the “0” mark to stop the rail drill.

TO RETRACT THE DRILL BIT

Move the control lever to the “retract” symbol to retract the drill bit.

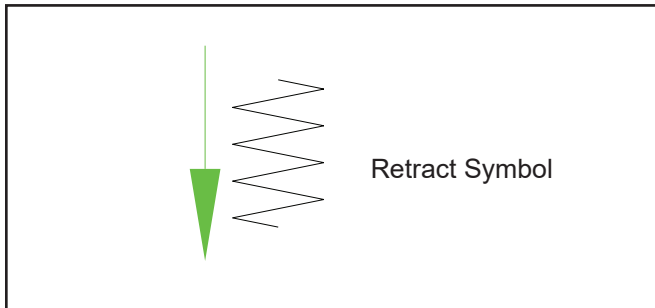

Figure 2. Retract the Drill Bit

REMOVING THE DRILL BIT

1. Uncouple the water hose from the rail drill.
2. Move the hydraulic circuit control valve to the OFF position and disconnect from the power supply.
3. From the bit end, turn the bit counter clockwise and pull it out.

STORAGE

- Clean the tool thoroughly.
- Remove the drill bit.
- Advance the piston .250 in./6 mm.
- Drain water from the tool.
- Retract the piston
- Store in a dry area.

COLD WEATHER OPERATION

Preheat the hydraulic fluid at low engine speed. When using the normally recommended fluids, fluid temperature should be at or above 50 °F/10 °C before use.

Use a biodegradable antifreeze solution such as windshield antifreeze in the spray can.

Drain water from the drill when finished using.

TEMPLATES & HOLE GUIDES

RAIL SIZE	RD12 DRILL TEMPLATE SETS: DOUBLE SIDED/ (SINGLE SIDED)	GUIDE ASSY P/N: ING (MM)/[INCHES]	COUNTRY
60 ASCE (6040)#	^(34525)		USA
65 ASCE (6540)#	^(35975)		USA
68GN	(52636)	38644 [2 1/8 × 4 1/2 × 7]	USA
70 ASCE #	^(49246)		USA
72 CHI & NW (7250)	^(35876)		USA
75 ASCE (7540)	^34262	22631 [2 11/16 × 5 1/2 × 5 1/2]	USA
75 GRT. NO.-1893	^(35701)		USA
75 U PAC C.R.S.#	^(36001)		USA
77 1/2 GRT. NO. #	^33720 ^(35876)	38644 [2 1/8 × 4 1/2 × 7]	USA
80 ASCE (8040) #	^(35626)/^38660		USA
80 GRT. NOR.#	^33720 ^(35876)	38644 [2 1/8 × 4 1/2 × 7]	USA
85 ASCE STD (8504 /8540)	^(34915)	[2 7/16 × 7 × 6] & ^(35358) [2 7/16 × 6 × 6]	USA
85 CAN. PAC. (8524)#	^(35628 HD)		USA
85 CP HEAD FREE (37337)	^(37337 HD)		USA
85 GRT. NOR.#	^33720 ^(35876)	[2 7/16 × 5]	USA
85PS	^37139		USA
85 SOO LINE (8520)	^(35630 HD)		USA
90 ARA-B (9030) 2 11/32 ELEVATION	^34263		USA
90 ASCE (9040)	^(36046)		USA
90 C&NW (9035)	^(35715)		USA
90 GN	^33720	35358 (2 7/16 × 6)	USA
90 RA (ARA-A)(9020) 90 SF	31978 / (31984)/35105 (65948 HD)	22631 [2 11/16 × 5 1/2 × 5 1/2] ^34680 [2-13/32 × 5 × 5]	USA
100 ARA-A (10020)	^34159 / ^35438/^38660	^34526 [3 × 6]	USA
100 ARA-B (10030) / 100-8	^(34916)		USA
100 RA HEAD FREE	^(37367)		USA
100 RE STD (10025) 2 45/64 ELEVATION	^34263 (65959 HD)	36037 [2 1/2 × 6 × 6]	USA
100 RE HEAD FREE (37341)	^(37341 HD)		USA
100 CN&W (10035)	^(34982)	39229 [2-31/32 × 6]	USA
100 GRT. NO.	^(35633)	38645 [2 7/16 × 7]	USA
100 NH (10034) 2 39/64" ELEVATION	80788		USA
100PS	^37139		USA
100 ASCE (10040)	^(65761 HD)		USA
105 DL (10533) 6" ELEVATION	^81104		USA
105 DUDLEY (10524)	^(34917)		USA
105 DUDLEY (OFFSET)	^(58508 OFFSET TEMPLATE)	58468 [2 × 4 3/4 × 4 3/4]	USA
110 GRT NO (11036)	^(35973)	38645 [2 7/16 × 7]	USA
110 RE GUARD RAIL	^(35151)		USA
110 RE (11025) 2 5/8 ELEVATION	^(34597)	^35357 [2 23/32 × 5 1/2]	USA
110 RE (11025) 2 53/64 ELEVATION	^(38683)		USA
112 RE (11228) 2 7/8" ELEVATION	33721/31979/31980/35105 (31985)(62201 HD)	^33687 [2 1/2 × 6 1/2 × 6 1/2]	USA
112TR	^33721	^33687 [2 1/2 × 6 1/2 × 6 1/2]	USA
113 HEAD FREE	^(34598)		USA

TEMPLATES & HOLE GUIDES

RAIL SIZE	RD12 DRILL TEMPLATE SETS: DOUBLE SIDED/ (SINGLE SIDED)	GUIDE ASSY P/N: ING (MM)/[INCHES]	COUNTRY
115 AREA RETARDER 3.484 FIXED ELEVATION	(34882 FI×ED) (34935 ADJ.)	34912 FI×ED / 34933 ADJ. [3 1/2]	USA
115 AREA (11525) 2 7/8" ELEVATION	31979/31980/35105/^35438 (31985)(62201 HD)	22625 [3 1/2 × 6 × 6]	USA
115 RE GUARD RAIL 3 1/32" ELEVATION	^(35153)		USA
119 AREA (11922) 2 7/8" ELEVATION	31979/31980/35105/ (31985) (62201 HD)	22625 [3 1/2 × 6 × 6]	USA
122 C.B. & O.	^34159(32279)	22625 [3 1/2 × 6 × 6]	USA
127 DUDLEY (12723)	^34264	22625 [3 1/2 × 6 × 6]	USA
129 TR	^(35003)		USA
130 AREA (13025)	^(36048)		USA
130 AREA HEAD FREE (3 1/16 ELEVATION)	^(41772)		USA
130 AREA HEAD FREE (2 15/16 ELEVATION)	^(38579)		USA
130 AREA HEAD FREE (2 3/4 ELEVATION)	^(38643)		
130 PS (13031)	^(34918)		USA
131 RE (13128)	31980/31981 / (31986)(62203 HD)	^33687 [2 1/2 × 6 1/2 × 6 1/2]	USA
131 RE-M	^34264	22625 [3 1/2 × 6 × 6]	USA
132 HEAD FREE	^(34599)		USA
132 AREA (13225)	31980/31981 / (31986)(62203 HD)	22625 [3 1/2 × 6 × 6]	USA
132 RE GUARD RAIL	^(35155)		USA
133 AREA (13331)	31979 / 31981 / (31987)	22625 [3 1/2 × 6 × 6]	USA
136 RE (2 3/8 ELEVATION)	^76709		USA
136 AREA (13622) (STD. 3 3/32" ELEVATION)	31980/31981 / (31986)(62203 HD)	22625 [3 1/2 × 6 × 6]	USA
136 AREA (3" ELEVATION)	(44977)	44975 [2-23/32 × 6 × 7]	USA
136 RE GUARD RAIL (3 9/32 ELEVATION)	^(35155)		USA
136 RE STOCK RAIL (3 11/32 ELEVATION)	(66945 HD)		USA
136 LVH	(62412)		USA
136 LV (13633)	(65075)		USA
140 AREA (14031)	31978 / (31988)	22625 [3 1/2 × 6 × 6]	USA
141 AREA	(43674) (65964 HD)	22625 [3 1/2 × 6 × 6]	USA
152 PS	^(43576)		USA
155 PS	^(43578)		USA
41 KG AS1085	^(35353)	41773 (62 × 127 × 127)	AUSTRALIA
47 KG AS1085	^(35353)	41773 (62 × 127 × 127)	AUSTRALIA
50 KG AS1085	^(35351)	41774 (88 × 130 × 130)	AUSTRALIA
53 KG (107#) AS1085	^(34185)	41774 (88 × 130 × 130)	AUSTRALIA
60 KG AS1085.1	^(34187)	41774 (88 × 130 × 130)	AUSTRALIA
TR-32 (SEE 65 ASCE)	^(35975)		BRAZIL
TR-37 (SEE 75ASCE)	^34262	22631 [2 11/16 × 5 1/2 × 5 1/2]	BRAZIL
TR-45 (SEE 90ARA-A)	^34262	22631 [2 11/16 × 5 1/2 × 5 1/2]	BRAZIL
TR-50 (SEE 100RE)			BRAZIL
TR-57 (SEE 115AREA)			BRAZIL
TR-68 (SEE 136AREA)			BRAZIL

TEMPLATES & HOLE GUIDES

RAIL SIZE	RD12 DRILL TEMPLATE SETS: DOUBLE SIDED/ (SINGLE SIDED)	GUIDE ASSY P/N: ING (MM)/[INCHES]	COUNTRY
50 KG N	31975 (43583)	29963 (77 × 130 × 130)	CHINA
60 KG	(69512)	69510 (76 × 140 × 140)	CHINA
46 KG U 33	31973		FRANCE
50 KG U 50	31974	29434 (60 × 170)	FRANCE
LP48	31973		FRANCE
60 KG UIC	31974	29434 (60 × 170)	FRANCE
S49	31976 / (31982)	31772 (46 × 165)	GERMANY
S54	31976 / (31982)	31772 (46 × 165)	GERMANY
60 KG UIC/UNI	31976 / (31983)	31772 (46 × 165)	GERMANY
54 KG UIC	^34261		HOLLAND
NP46	^34261		HOLLAND
I.R.S. 52KG	(66830)	66831 (80 × 166)	INDIA
60KG UIC	(31983)	66831 (80 × 166)	INDIA
36 KG U 33			ITALY
50 KG UNI **	31976 / (31982)	30675 (47 × 165)	ITALY
60 KG UIC/UNI	31976 / (31983)	30675 (47 × 165)	ITALY
60 KG	31975	29963 (77 × 130 × 130)	JAPAN
50 KG N	31975 (43583)	29963 (77 × 130 × 130)	JAPAN
P50	(66321 HD)	66324 (65 × 150 × 140)	RUSSIA
P65	(66323 HD)	66326 (95 × 220)	RUSSIA
54KG UIC	^34261	^32276 (58 × 170)	SPAIN
37 KG JIS/JRS	^(43580)	44927 (60.5 × 127)	TAIWAN
50 KG N	31975 ^(43583)	29963 (77 × 130 × 130)	TAIWAN
60 KG UIC	31976	31772 (46 × 165)	TAIWAN
87LB B.H.	^(35251)		UK
90LB B.H.	^(35255)	^(35284) (60 × 114)	UK
92LB F.B.	^(35257)	^(35283) (54 × 114)	UK
95LB F.B. MARK A	^(35249)		UK
95LB F.B. MARK B	^(35470)		UK
98			UK
109BR			UK
54KG UIC (BS 113A) 70MM HOLE ELEVATION	34261	38889 (65 × 200)	UK
UIC60 INSULATED	(71558)	71459 (62 × 170 × 170)	UK
CIE 50	^(39233)	39236 (57 × 120)	UK
RILC/RILR	*(E32009)		EUROPE
RI60/RI60N	*(E32010)		EUROPE
PH37	*(E32011)		EUROPE

* = NOT RELEASED, TEMPLATE ONLY NOT A SET

^ = AVAILABLE BY SPECIAL ORDER ONLY

= REQUIRES CHAMFERED CYLINDER CASTING

TOOL PROTECTION & CARE

NOTICE

In addition to the Safety Precautions found in this manual, observe the following for equipment protection and care.

- Make sure all couplers are wiped clean before connection.
- The hydraulic circuit control valve must be in the OFF position when coupling or uncoupling hydraulic tools. Failure to do so may result in damage to the quick couples and cause overheating of the hydraulic system.
- Always store the tool in a clean dry space, safe from damage or pilferage.
- Make sure the circuit PRESSURE hose (with male quick disconnect) is connected to the IN port. The circuit RETURN hose (with female quick disconnect) is connected to the opposite port. Do not reverse circuit flow. This can cause damage to internal seals.
- Always replace hoses, couplings and other parts with replacement parts recommended by STANLEY. Supply hoses must have a minimum working pressure rating of 2500 psi/172 bar.
- Do not exceed the rated flow (see Specifications) in this manual for correct flow rate and model number. Rapid failure of the internal seals may result.
- Always keep critical tool markings, such as warning stickers and tags, legible.
- Tool repair should be performed by experienced personnel only.
- Make certain that the recommended relief valves are installed in the pressure side of the system.
- Do not use the tool for applications for which it was not intended.

TROUBLESHOOTING

If symptoms of poor performance develop, the following chart can be used as a guide to correct the problem.

When diagnosing problems with operation of the drill, always check that the hydraulic power source is supplying the correct hydraulic flow and pressure to the tool as listed in the specifications. Use a flowmeter known to be accurate. Check the flow with the hydraulic oil temperature at least 80 °F/27 °C.

PROBLEM	CAUSE	SOLUTION
Drill does not run.	Hydraulic power source not functioning.	Check power source for proper flow and pressure, 8–10 gpm/30–38 lpm, 2000 psi/140 bar.
	Couplers or hoses blocked.	Locate and remove restriction.
	Hydraulic motor failure.	Inspect and repair.
	Hydraulic lines not connected.	Connect lines.
Drill bit dulls quickly.	Incorrect oil flow.	Check that 8–10 gpm/30–38 lpm at 2000 psi/140 bar is available at the rail drill.
	Using insufficient amount of coolant.	Rotate or replace insert. Increase flow of coolant. Make sure pressure tank is fully pumped up. Check for plugged water port in drill bit. Check for a clogged inlet filter. Remove pipe plug in end cap and flush with water. Remove end cap and clean filter.
Drill moves on rail during drilling operation.	Not clamped properly.	See clamping instructions.
	Wrong templates.	Use correct templates and verify fit to rail.
	Template knob(s) not tight	Tighten knobs securely.
Drill vibrates during drilling.	Inserts dull or damaged.	Rotate or replace inserts.
	Template knob(s) loose.	Tighten knobs securely.
	Not clamped properly.	See clamping instructions.
Inserts chipped.	Some chipping is normal, particularly on the inside insert.	Rotate or replace if poor hole finish is noted.
	Incorrect template.	Use correct template and verify fit.
	Using insufficient amount of coolant.	Rotate or replace insert. Increase flow of coolant. Make sure pressure tank is fully pumped up. Check for plugged water port in drill bit. Check for a clogged inlet filter. Remove pipe plug in end cap and flush with water. Remove end cap and clean filter.
	Not clamped properly.	See clamping instructions.
	Template knob(s) loose	Tighten knob(s) securely.
	Handling damage.	Make sure drill bit is retracted when installing the drill on the rail. Avoid insert contact with hard objects.
Insert screw difficult to remove.	Not assembled with lubricant.	Install screw with anti-seize lubricant on the threads.

SPECIFICATIONS

Bit Capacity	up to 1-9/16 in. diameter/36 mm diameter
Bit Type.....	Carbide Inserts (2) on Insert Holder
Pressure	2000 psi/140 bar
Flow Range	8 - 10 gpm/30 – 38 lpm
Porting	-8 SAE O-ring
Connect Size and Type	3/8 in. Flush Face Couplers
Weight (with couplers) (w/o templates & bit)	59 lb/26.75 kg
Length (handle extended to maximum).....	33 inches/84 cm
Width	8.5 inches/21.6 cm
Height (w/o templates) (maximum).....	21 inches/53.35 cm
EHTMA Category.....	“D” (30 lpm @ 138 bar)
Sound Power Level	100.7 dBA
Vibration Level.....	N/A

NOTE: Weights, dimensions, and operating specifications listed are subject to change without notice. Where specifications are critical to your application, please consult the factory.

ACCESSORIES

RAIL TEMPLATES & HOLE GUIDES

See “TEMPLATES & HOLE GUIDES” under the “OPERATION” section of this manual.

Ten-Piece Carbide Insert Kit (includes the following)	31969
Carbide Insert Package (10 inserts per package)	
Flat Head Capscrew (Torx 5.40 × 1/4)	

DRILL BITS

1 in. Drill Bit	29471
1-1/16 in. Drill Bit	29470
1-1/8 in. Drill Bit	29469
1-3/16 in. Drill Bit	29468
1-1/4 in. Drill Bit	29467
1-5/16 in. Drill Bit	29461
1-3/8 in. Drill Bit	29465
1-7/16 in. Drill Bit	32511
1-1/2 in. Drill Bit	32510
1-9/16 in. Drill Bit	33331
1-5/8 in. Drill Bit	67267
1-11/16 in. Drill Bit	67268
1-13/16 in. Drill Bit	72652
22 mm Drill Bit	31808
23 mm Drill Bit	29475
24 mm Drill Bit	30563
25 mm Drill Bit	31674
26 mm Drill Bit	31619
27 mm Drill Bit	31622
28 mm Drill Bit	29474
30 mm Drill Bit	29473
31 mm Drill Bit	31675
32 mm Drill Bit	31624
33 mm Drill Bit	29472
36 mm Drill Bit	31647

SERVICE TOOLS

Piston Seal Installation Kit	31879
Piston Wrench	28868

RD12 PARTS ILLUSTRATION

MODEL RD12100 & RD12101

SEE PAGE 20
FOR CLAMP
ASSEMBLY

NOTE: CAN ALSO BE INSTALLED
ON UNITS WITH S/N 002639 AND
LOWER. ITEMS SHOWN IN BOX
MUST REPLACE PREVIOUS
ITEMS.

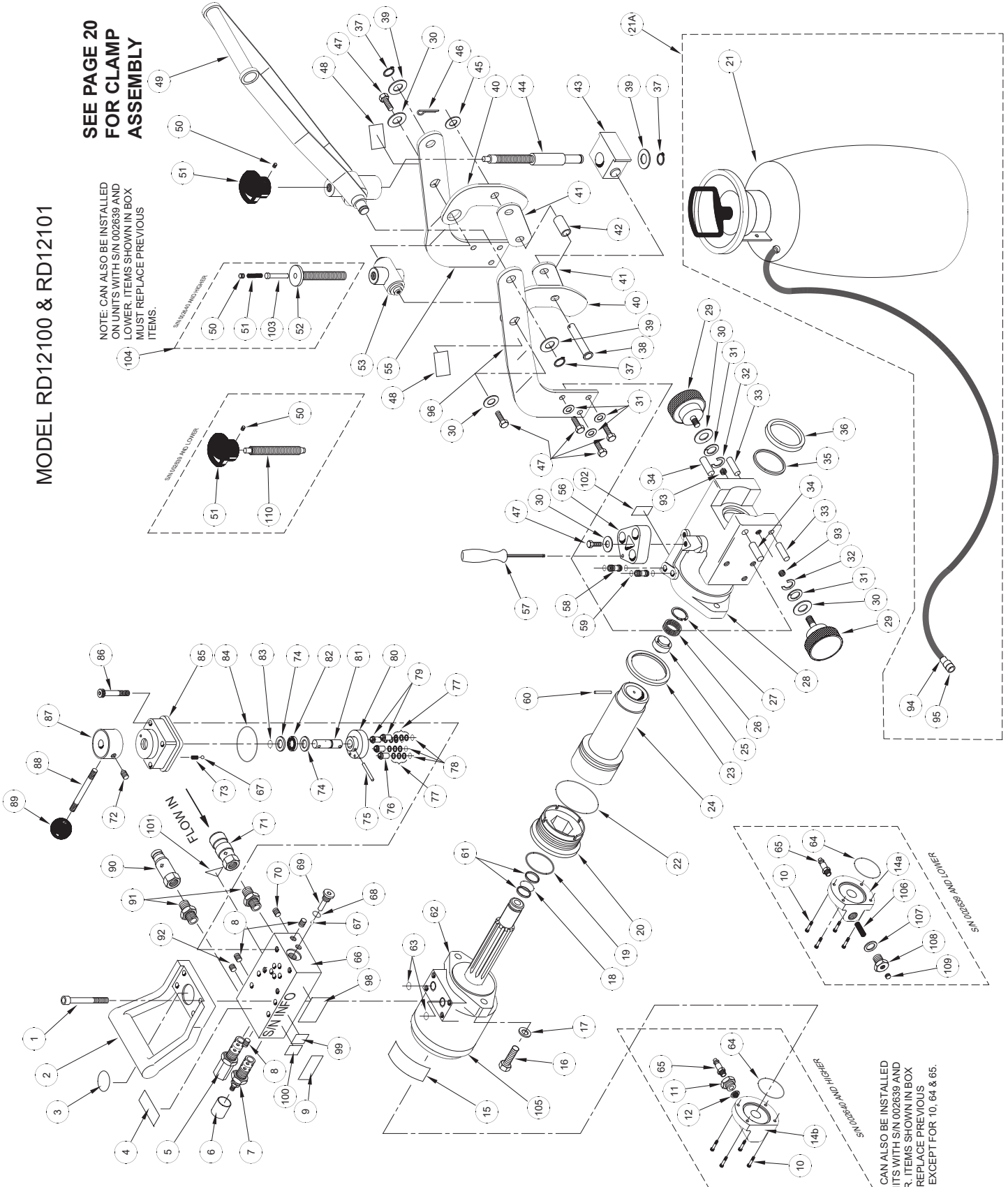

NOTE: CAN ALSO BE INSTALLED
ON UNITS WITH S/N 002639 AND
LOWER. ITEMS SHOWN IN BOX
MUST REPLACE PREVIOUS
ITEMS EXCEPT FOR 10, 64 & 65.

RD12 PARTS LIST

ITEM	PART NO.	QTY	DESCRIPTION
1	24871	4	CAPSCREW
2	24844	1	CARRY HANDLE
3	31097	1	OPERATION DECAL
4	----	1	NO ITEM
5	34059	1	PRESSURE RELIEF VALVE
6	25774	1	TAMPER RESISTANT COVER
7	24868	1	FLOW CONTROL
8	00955	4	1/8" PIPE PLUG
9	74765	1	RD12 MODEL NO. STICKER
10	15909	4	CAPSCREW
11	60787	1	FITTING
12	24441	1	FILTER WASHER
13	—	—	NO ITEM
14	60785	1	COVER
15	73680	1	RAILROAD HELP DESK STICKER
16	370251	2	CAPSCREW
17	03061	2	LOCK WASHER
18	02003	1	O-RING 2-113 R16 •
19	24878	1	FACE SEAL
20	60782	1	PLUG ASSY
21	24774	1	SPRAY CAN ASSY (INCL 94 & 95)
22	04054	1	O-RING 2-233 R17
23	76777	1	PISTON RING
24	31286	1	PISTON MACHINING ASSY
25	29303	1	WATER VALVE
26	29302	1	WAVE SPRING
27	29301	1	RETAINING RING
28	60783	1	CYLINDER MACHINING ASSY
29	31828	2	KNOB
30	371067	5	FLAT WASHER
31	01459	12	LOCK WASHER
32	30652	2	RETAINING RING
33	29126	2	DOWEL PIN
34	29125	2	DOWEL PIN
35	07287	1	QUAD RING •
36	24881	1	WIPER SEAL •
37	17904	3	RETAINING RING
38	29197	1	CLEVIS PIN
39	28228	3	WASHER
40	28902	2	PLATE
41	29136	2	LINK
42	31069	1	SPACER
43	29075	1	STOP
44	28955	1	THREADED SHAFT
45	20876	2	WASHER

ITEM	PART NO.	QTY	DESCRIPTION
46	01924	1	COTTER PIN
47	06173	9	CAPSCREW
48	17572	2	PINCH POINT WARNING STICKER
49	29072	1	HANDLE WELDMENT
50	38581	1	SETSCREW
51	02916	1	SPRING
52	35724	1	ADJUSTMENT SCREW
53	39449	1	ADJUSTMENT NUT
55	29070	1	CLAMP ARM LH
56	28867	1	GROMMET
57	29123	1	TORX SCREW DRIVER
58	24818	2	OIL TUBE
59	00055	4	O-RING 2-012 R17 •
60	29127	1	DOWEL PIN
61	08928	2	BACK-UP RING 9/16 × 3/32 •
62	29134	1	HYDRAULIC MOTOR
63	19095	2	O-RING 2-114 R17 •
64	00253	1	O-RING 2-038 R16 •
65	22521	1	QUICK DISCONNECT NIPPLE
66	27618	1	VALVE BLOCK ASSEMBLY
67	20145	2	STEEL BALL
68	01411	1	O-RING 3-906 R17 •
69	24289	1	PLUG
70	04119	1	PIPE PLUG
71	03972	1	FEMALE COUPLER BODY
72	24300	1	SETSCREW
73	24876	1	SPRING
74	20761	2	BEARING RACE
75	07890	1	ROLL PIN
76	34585	1	GROMMET
77	24305	12	SPRING WASHER
78	01362	4	O-RING 2-011 R16 •
79	24231	3	GROMMET
80	24877	1	ROTOR ASSY
81	24233	1	SHAFT
82	20762	1	BEARING
83	17924	1	O-RING 2-012 R24 •
84	02177	1	O-RING 2-137 R17 •
85	24313	1	HOUSING ASSY
86	26297	4	CAPSCREW
87	17527	1	VALVE CAP
88	24291	1	ROD
89	02633	1	KNOB
90	03973	1	MALE COUPLER BODY
91	00936	2	ADAPTER

RD12 PARTS LIST

ITEM	PART NO.	QTY	DESCRIPTION
93	00698	2	HELICOIL
94	22748	1	HOSE CLAMP 9/16
95	24784	1	QUICK DISCONNECT COUPLER
96	29071	1	CLAMP ARM RH
97	—	—	NO ITEM
98	28322	1	CE STICKER
99	31049	1	EYE PROTECTION STICKER
100	28788	1	MANUAL STICKER
101	11207	1	CIRCUIT D STICKER
102	81441	1	SOUND POWER LEVEL STICKER
103	35725	1	PLUNGER
104	35726	1	ADJUSTMENT SCREW ASSY (IF PURCHASED AS AN ASSEMBLY, THIS CAN BE INSTALLED ON ALL RAIL DRILLS.)
105	65622	1	NO LONGER AVAILABLE
106	31098	1	SCREEN
107	31099	1	GASKET
108	31100	1	END CAP
109	00961	1	PIPE PLUG
110	28956	1	ADJUSTMENT SCREW
111	24874	1	SETSCREW
112	24873	1	PLASTIC KNOB
113	67475	1	RD12 CLAMP ASSEMBLY (INCLUDES ITEMS 30, 31, 37 THRU 55, 96, 102, 103, 111 & 112)

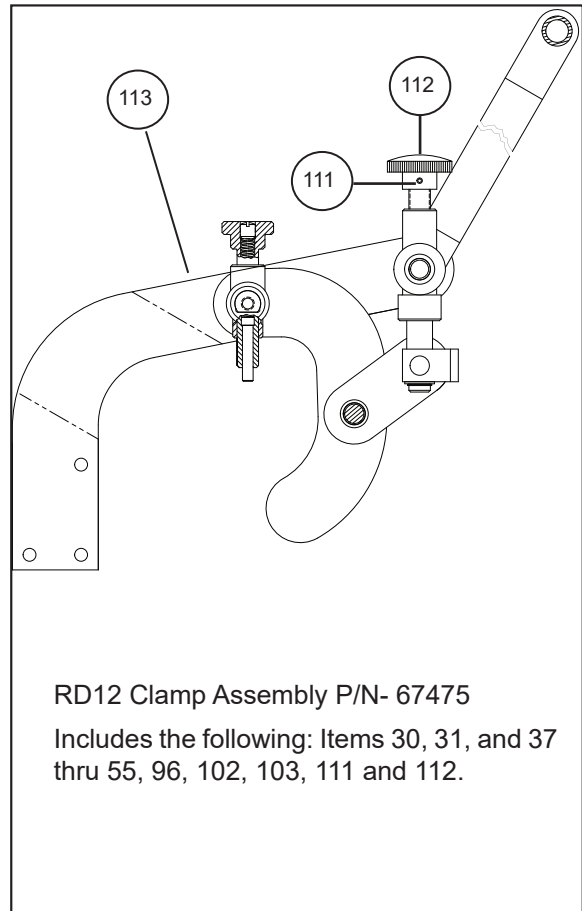

Seal Kit P/N 32031 (• Denotes part in Seal Kit)

Motor Seal Kit P/N 28658

STANLEY®

STANLEY Infrastructure
6430 SE Lake Road
Portland, Oregon 97222 USA
(503) 659-5660 / Fax (503) 652-1780
www.stanleyinfrastructure.com